

*Ultra-Stable High-Finesse Cavity*

# Catalog 2024

*Optical Components & Technical Capabilities*

**Edition:** 2<sup>nd</sup> Edition, © LAYERTEC, 2024, January

**Phone:** +49 36453 744 0

**E-mail:** [info@layertec.de](mailto:info@layertec.de)

Internet: [www.layertec.de](http://www.layertec.de)

Fax: +49 36453 744 40

Phone (US): +1 707 48 10216

E-mail (US): [ussales@layertec.com](mailto:ussales@layertec.com)

Location: LAYERTEC GmbH  
Ernst-Abbe-Weg 1  
99441 Mellingen  
GERMANY

Images: LAYERTEC GmbH

### New: Ultra-Stable High-Finesse Cavity



This assembly consists of two highly reflective mirrors made of Fused Silica or ULE, which are coated using sputtering techniques. The mirrors are manufactured according to customer requirements (wavelengths, reflectance, transmittance). Typically, the resonator optics achieve reflection values of 99.999 % at a wavelength of 1540 nm and 99.998 % at 700 nm with a transmittance of 5 ppm. The optical components are connected to a spacer made of ULE, which is also manufactured according to customer specifications (geometry, material, etc.). At 1540 nm we guarantee a finesse of 250,000 – 300,000. The mirrors are joined to the cavity by optical contacting and laser welding without any additives. Laser welding guarantees high mechanical stability of the cavity.

# Introduction

## Welcome

LAYERTEC is a globally recognized producer of optical components.

The main focus is on the commercial production of high-performance optics for laser applications in the wavelength range 125 nm to 8  $\mu$ m, including large scale optics.

LAYERTEC is able to manufacture complex components as single pieces or in series and offers the complete manufacturing chain:

- Precision optics manufacturing of flat, spherical, aspherical and cylindrical surfaces from 1 to 2000 mm edge length
- Metallic, fluoridic and oxidic coatings with evaporation and sputtering technologies
- Structuring of optical coatings
- Joining services
- Laser engraving
- Ultrasonic-machined glass substrates (weight reduction, drillings)
- Extensive optical metrology for quality control

LAYERTEC is certified according to DIN EN ISO 9001-2015.

### Many Technologies are waiting for your Ideas

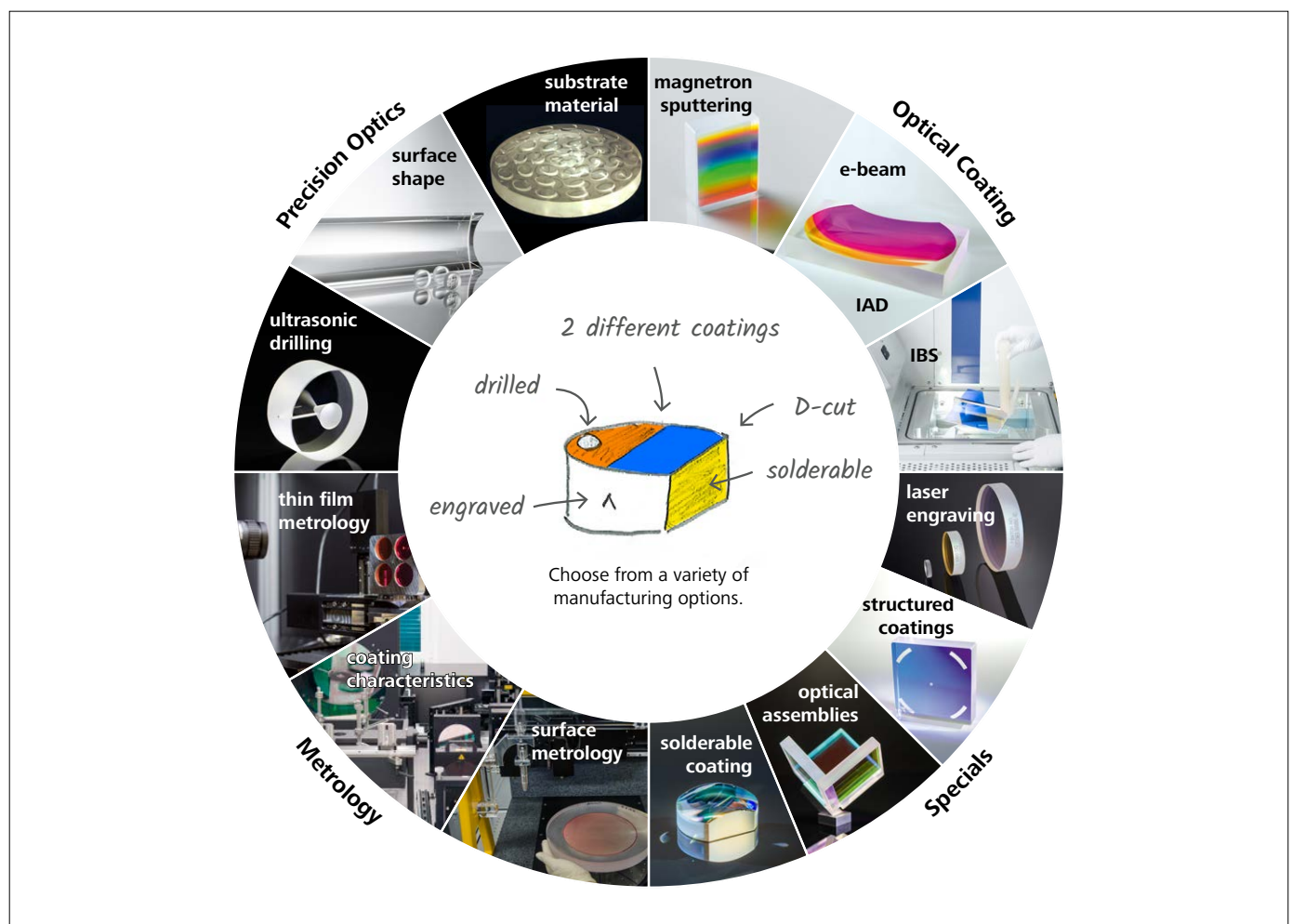


Figure 1: LAYERTEC's technical manufacturing capabilities

# Table of Contents

<b>Introduction</b> .....	<b>1</b>
Welcome.....	1
Table of Contents .....	2

## Optical Coatings 4

<b>Selection of Optical Components for Common Laser Types</b> .....	<b>4</b>
F <sub>2</sub> Lasers (157 nm).....	5
ArF Lasers (193 nm) .....	7
KrF, XeCl, XeF Lasers (248 nm, 308 nm, 351 nm) .....	9
Ruby and Alexandrite Lasers (694 nm, 755 nm).....	12
Ti:Sapphire Lasers operated with ns-Pulses (550 – 1100 nm) .....	14
Diode Lasers (620 – 680 nm, 808 – 990 nm).....	16
High Power Lasers on the Basis of Yb- and Nd-doped Materials (1020 – 1080 nm) .....	18
Second Harmonic of High Power Lasers on the Basis of Yb- and Nd-doped Materials (515 nm, 532 nm).....	21
Third Harmonic of High Power Lasers on the Basis of Yb- and Nd-doped Materials (343 nm, 355 nm) .....	23
Higher Harmonics of High Power Lasers on the Basis of Yb- and Nd-doped Materials (213 nm, 266 nm).....	25
Weak Nd:YAG or Nd:YVO <sub>4</sub> Laser Lines (915 nm, 946 nm, 1123 nm, 1340 nm) .....	27
Ho:YAG and Tm:YAG Lasers (2010 nm, 2100 nm) .....	29
Er:YAG Lasers and the 3 μm Region.....	32

<b>Ultrafast Laser Optics</b> .....	<b>34</b>
Introduction to Ultrafast Laser Optics .....	35
Standard Ultrafast Laser Optics (120 – 150 nm Bandwidth) .....	37
Broadband Ultrafast Laser Optics (200 – 300 nm Bandwidth) .....	44
Octave Spanning Ultrafast Laser Optics (400 – 500 nm Bandwidth).....	49
Silver Mirrors for Ultrafast Lasers (550 – 1100 nm) .....	52
High Power Ultrafast Laser Optics (550 – 1100 nm).....	54
Components for the Second Harmonic of the Ti:Sapphire Laser (300 – 600 nm).....	57
Components for the Third Harmonic of the Ti:Sapphire Laser (250 – 400 nm) .....	60
Components for the Higher Harmonics of the Ti:Sapphire Laser (140 – 250 nm) .....	62
Gires-Tournois-Interferometer (GTI) Mirrors (600 – 1600 nm).....	64
Optics for Ultrafast Lasers in the Wavelength Range of 1000 – 1600 nm.....	67

<b>Selected Special Components</b> .....	<b>70</b>
Components for Optical Parametric Oscillators (OPO).....	71
Broadband and Scanning Mirrors (300 – 2500 nm) .....	76
Filters for Laser Applications (260 – 2500 nm) .....	78
Thin Film Polarizers.....	80
Low Loss Optical Components (340 – 3000 nm).....	82
Coatings on Crystal Optics (340 – 3000 nm).....	84

<b>Metallic Coatings</b> .....	<b>86</b>
Front Surface Silver Mirrors (400 – 4000 nm).....	87
Front Surface Aluminum Mirrors (150 – 900 nm).....	90
Special Metallic Coatings (400 – 10 000 nm).....	93

## Standard Catalog 95

<b>Standard Items from Stock</b> .....	<b>95</b>
Standard Items from Stock .....	97
Specifications of Plane Substrates.....	98
Specifications of Curved Substrates .....	100
Excimer Lasers [193 nm, 248 nm, 308 nm] .....	102
fs-Laser [TiSa, up to 150 nm bandwidth] .....	104
fs-Laser [TiSa, 300 nm bandwidth].....	109
ps/fs-Laser [1030–1040 nm].....	113
cw/ns-Laser [1030–1064 nm].....	117
2 μm [Ho:YAG Tm:YAG] .....	123
3 μm [Er:YAG] .....	125
Metallic Mirrors.....	127
Low Loss Mirrors for CRD-Measurements .....	129
Low Loss Mirror Set for High Finesse Cavities .....	130
Beam Expanders.....	132

<b>Technology</b>	<b>133</b>
<b>Precision Optics</b> .....	<b>133</b>
How to Specify Substrates.....	134
Standard Quality Substrates.....	136
Substrate Materials.....	138
Optical Fabrication Methods.....	142
Measurement Tools for Testing Substrates.....	152
<b>Optical Coatings</b> .....	<b>156</b>
Coating Technologies.....	157
Optical Interference Coatings.....	160
Metallic Coatings.....	166
Metal-Dielectric Coatings.....	167
Measurement Tools for Optical Coatings.....	168
<b>Specials</b> .....	<b>176</b>
Solderable Coatings.....	177
Lithography.....	178
Optical Assemblies.....	179
Laser Engraving.....	181
<b>Knowhow</b>	<b>182</b>
<b>Knowhow</b> .....	<b>182</b>
Polarization.....	183
Dielectric Mirrors – Non-Normal Incidence.....	184
Weakly Curved Substrates.....	185
Surface Form Tolerances.....	186
Surface Imperfection Tolerances.....	187
Laser-Induced Damage Threshold (LIDT).....	188
Group Delay Distortion (GD & GDD).....	189
How to Mount Optics.....	190
Cleaning of Optical Surfaces.....	191
<b>Company</b>	<b>192</b>
<b>Company</b> .....	<b>192</b>
History.....	193
General Terms and Conditions of Sale (Effective 01/04/2016).....	197
Payment and Shipment.....	202
Imprint.....	203

# Selection of Optical Components for Common Laser Types

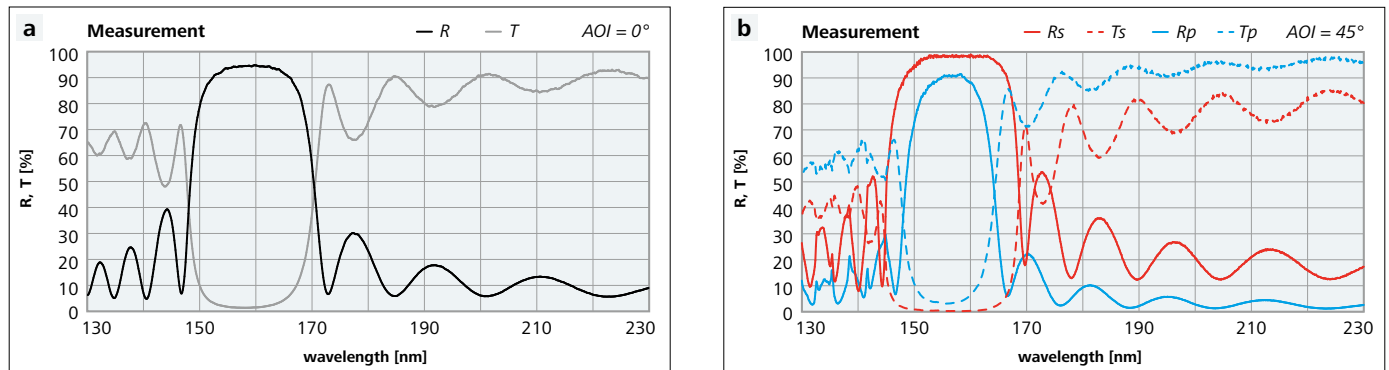
## Chapter Index

<b>F<sub>2</sub> Lasers (157 nm)</b> .....	<b>5</b>	<b>Second Harmonic of High Power Lasers on the Basis of Yb- and Nd-doped Materials (515 nm, 532 nm)</b> .....	<b>21</b>
Mirrors .....	5	Dual Wavelength Turning Mirror .....	21
Output Couplers .....	5	Dual Wavelength Cavity Mirror .....	21
Aluminum Mirrors for F <sub>2</sub> Lasers .....	6	Separators for the Second Harmonic and the Fundamental Wave .....	21
Technical Data of Standard F <sub>2</sub> Laser Components .....	6	Thin Film Polarizers .....	22
Components for the Fifth and Sixth Harmonic of Ti:Sapphire Lasers .....	6	Non-Polarizing Beam Splitters .....	22
<b>ArF Lasers (193 nm)</b> .....	<b>7</b>	Coating on Nonlinear Optical Crystals .....	22
Mirrors .....	7	<b>Third Harmonic of High Power Lasers on the Basis of Yb- and Nd-doped Materials (343 nm, 355 nm)</b> .....	<b>23</b>
Output Couplers .....	7	Standard Components .....	23
Aluminum Mirrors .....	8	Turning Mirrors .....	23
Technical Data of Standard ArF Laser Components .....	8	Standard Separators .....	23
Components for the Fourth Harmonic of Ti:Sapphire Lasers .....	8	Special Separators .....	23
<b>KrF, XeCl, XeF Lasers (248 nm, 308 nm, 351 nm)</b> .....	<b>9</b>	Windows and Lenses .....	24
Cavity Mirrors .....	9	Sputtered Multiple Wavelength Mirrors .....	24
Fluorine Resistant Cavity Mirrors .....	9	Sputtered Thin Film Polarizers .....	24
Output Couplers .....	9	<b>Higher Harmonics of High Power Lasers on the Basis of Yb- and Nd-doped Materials (213 nm, 266 nm)</b> .....	<b>25</b>
Fluorine Resistant Output Couplers .....	10	Multiple Wavelength Mirrors .....	25
Windows and Lenses .....	10	Separators for the Fourth Harmonic .....	25
Turning Mirrors .....	10	Separators for the Fifth Harmonic .....	25
Attenuators .....	11	Special Separators .....	26
LIDT and Lifetime Data .....	11	Thin Film Polarizers .....	26
<b>Ruby and Alexandrite Lasers (694 nm, 755 nm)</b> .....	<b>12</b>	<b>Weak Nd:YAG or Nd:YVO<sub>4</sub> Laser Lines (915 nm, 946 nm, 1123 nm, 1340 nm)</b> .....	<b>27</b>
Cavity Mirrors .....	12	<b>Ho:YAG and Tm:YAG Lasers (2010 nm, 2100 nm)</b> .....	<b>29</b>
Turning Mirrors .....	12	Cavity Mirrors .....	29
Beam Combiners .....	13	Turning Mirrors .....	29
Output Couplers .....	13	Output Couplers .....	30
<b>Ti:Sapphire Lasers operated with ns-Pulses (550 – 1100 nm)</b> .....	<b>14</b>	Edge Filters .....	30
Cavity Mirrors .....	14	Thin Film Polarizers .....	30
Pump Mirrors .....	14	Windows and Lenses .....	31
Turning Mirrors .....	15	<b>Er:YAG Lasers and the 3 μm Region</b> .....	<b>32</b>
Output Couplers .....	15	Cavity Mirrors .....	32
<b>Diode Lasers (620 – 680 nm, 808 – 990 nm)</b> .....	<b>16</b>	Pump Mirrors .....	32
Turning Mirrors .....	16	Turning Mirrors .....	32
Scanning Mirrors .....	16	Beam Combiners and Alignment Laser Mirrors .....	33
Thin Film Polarizers .....	16	Output Couplers and Lenses .....	33
Conventional Steep Edge Combiners for Diode Lasers .....	17		
Special Steep Edge Combiners for Unpolarized Light .....	17		
<b>High Power Lasers on the Basis of Yb- and Nd-doped Materials (1020 – 1080 nm)</b> .....	<b>18</b>		
Mirrors .....	18		
Edge Filters and Pump Mirrors .....	18		
Thin Film Polarizers .....	19		
Picosecond Lasers based on Yb-doped Materials .....	19		
Alignment and Process Monitoring .....	20		
Beam Splitters and Output Couplers .....	20		
Non Polarizing Beam Splitters .....	20		

## F<sub>2</sub> Lasers (157 nm)

- High quality mirror substrates, windows and lenses of CaF<sub>2</sub> (193 nm excimer grade quality, HELMA Materials GmbH)
- Please note that the 157 nm excimer grade CaF<sub>2</sub> can no longer be offered. The market for this kind of material is too small compared to the huge effort necessary for the crystal manufacturers to test the material according to this quality standard. Thus, all LAYERTEC optics for F<sub>2</sub> lasers will be manufactured using 193 nm excimer grade material in the future.
- PR coatings with tolerances of:
  - ± 2 % for R = 10 % ... 30 %
  - ± 3 % for R = 30 % ... 75 %
  - and ± 2 % for R = 75 % ... 90 %
- Development and production of customer specific components like beam splitters and variable attenuators on request

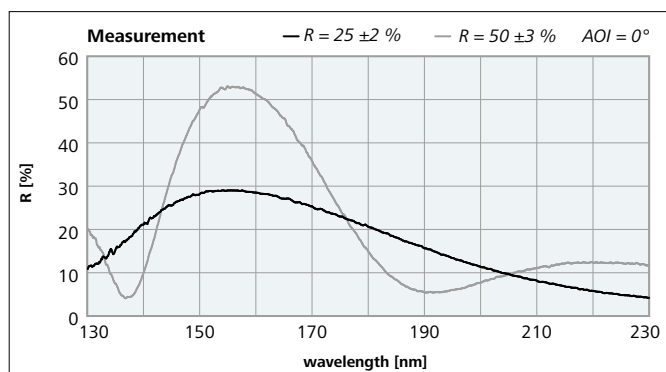
### Mirrors



**Figure 1:** Measured reflectance and transmittance spectra of mirrors for 157 nm  
**a)** Laser mirror (AOI = 0°)  
**b)** Turning mirror (AOI = 45°)

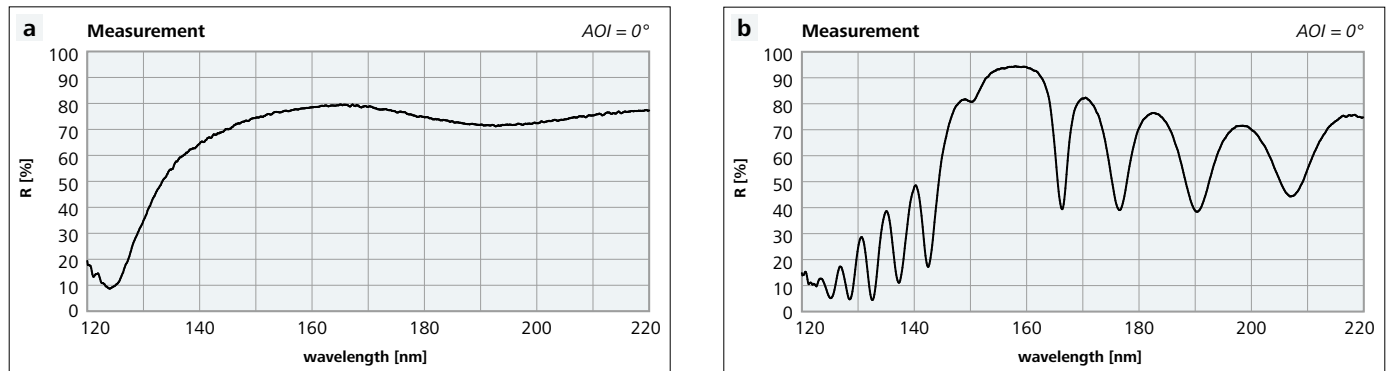
- Laser mirrors:
  - R = 92 % ... 95 % at AOI = 0°
- Turning mirrors (AOI = 45°):
  - Rs > 95 %
  - Rp > 90 %
  - Ru > 92 %

### Output Couplers



**Figure 2:** Measured reflectance spectra of standard output couplers with: R = 50 % ± 3 % and R = 25 % ± 2 % (rear side uncoated)

### Aluminum Mirrors for F<sub>2</sub> Lasers



**Figure 3:** Reflectance spectra of aluminum mirrors  
**a)** Protected aluminum mirror  
**b)** Enhanced aluminum mirror for 157 nm

- Protected aluminum mirrors (optimized for 157 nm): R = 74 % ... 78 %
- Dielectrically enhanced aluminum mirrors: up to R = 94 % at AOI = 0°
- For more information on aluminum mirrors see page 90 f.

### Technical Data of Standard F<sub>2</sub> Laser Components

**Table 1:** Technical Data of Standard F<sub>2</sub> Laser Components

Coating	Spectral Performance	Lifetime Tests
HR (0°, 157 nm)	R = 92 % ... 95 %	2 × 10 <sup>8</sup> – 1 × 10 <sup>9</sup> pulses*
HR (45°, 157 nm)	R = 90 % ... 94 % (unpol. light)	
PR (0°, 157 nm)	R = 50 % ±3 %	2 × 10 <sup>8</sup> – 1 × 10 <sup>9</sup> pulses*
PR (0°, 157 nm)	R = 25 % ±2 %	2 × 10 <sup>8</sup> – 1 × 10 <sup>9</sup> pulses*
AR (0°, 157 nm)	R = 0.3 % ... 0.7 %	

\* Energy density 25 mJ/cm<sup>2</sup>, repetition rate 800 Hz, pulse duration 15 ns; tested at COHERENT AG, München

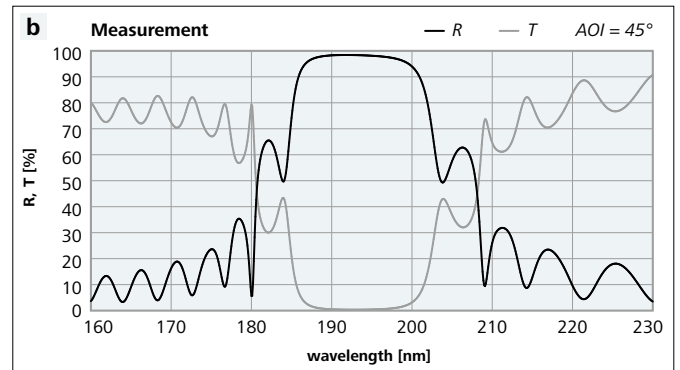
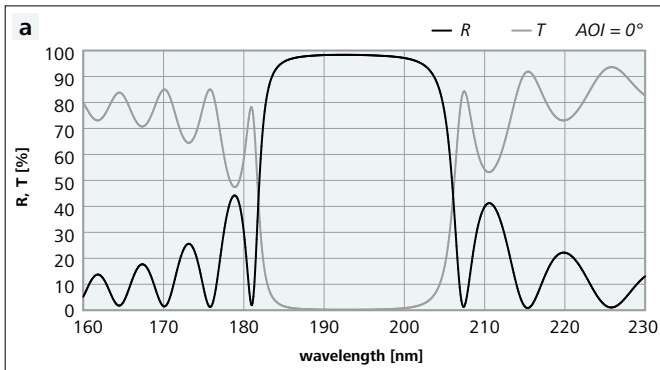
### Components for the Fifth and Sixth Harmonic of Ti:Sapphire Lasers

Mirrors and separators for the 133 nm and 160 nm range are produced by coating techniques which were developed for F<sub>2</sub> laser coatings. For more information please see page 62 f.



# ArF Lasers (193 nm)

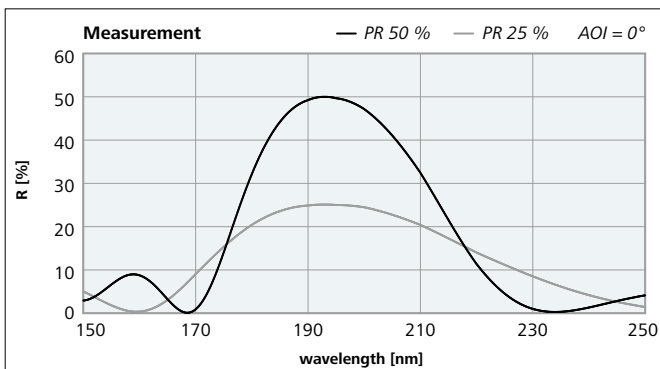
## Mirrors



**Figure 1:** Reflectance and transmittance spectra of mirrors for 193 nm  
**a)** Resonator mirror (AOI = 0°)  
**b)** Turning mirror (AOI = 45°, unpolarized light)

- All fluoride systems guarantee high reflectance and high damage thresholds
- High quality mirror substrates, windows and lenses of CaF<sub>2</sub> (193 nm excimer grade, HELMA Materials GmbH) and Fused Silica
- Development and production of customer specific components such as beam splitters and variable attenuators on request

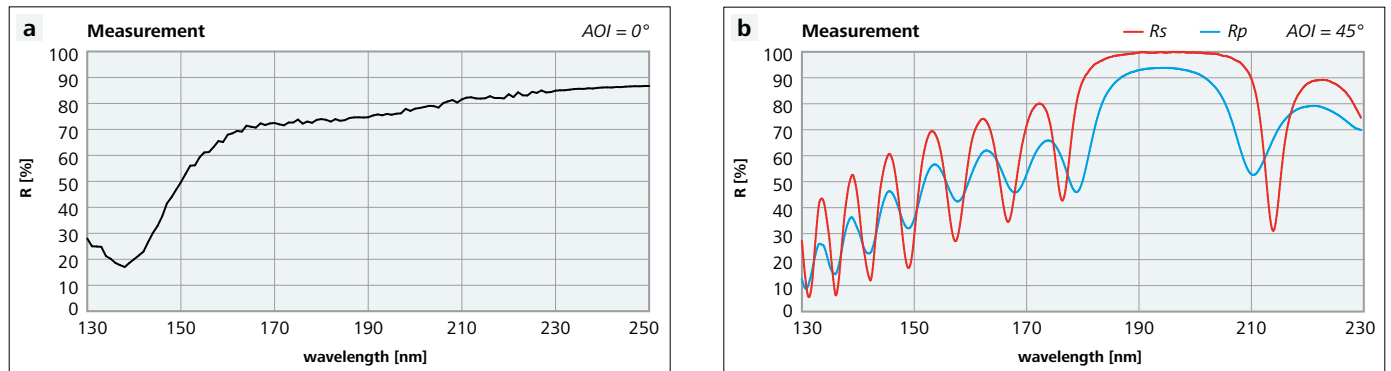
## Output Couplers



**Figure 2:** Reflectance spectra of output couplers with  
 $R(0^\circ, 193 \text{ nm}) = 50 \% \pm 3 \%$  and  
 $R(0^\circ, 193 \text{ nm}) = 25 \% \pm 2 \%$  (coated side only)

- PR coatings with tolerances of:
  - $\pm 2 \%$  for  $R = 10 \% \dots 30 \%$
  - $\pm 3 \%$  for  $R = 30 \% \dots 75 \%$
  - $\pm 2 \%$  for  $R = 75 \% \dots 90 \%$
  - $\pm 1 \%$  for  $R > 90 \%$
- Single wavelength AR coating with residual reflectance values of:
  - $R < 0.25 \%$  at AOI = 0° and
  - $R < 0.6 \%$  at AOI = 45° (unpolarized light)
- Broadband and multiple wavelength AR coatings

## Aluminum Mirrors



**Figure 3:** Reflectance spectra of aluminum mirrors.  
**a)** Protected aluminum mirror optimized for 193 nm  
**b)** Enhanced aluminum mirror for 193 nm, AOI = 45°

- Enhanced aluminum mirrors:

Rp > 93 %  
 Rs > 98 %  
 Ru > 96 %

For more information on aluminum mirrors see page 90.

## Technical Data of Standard ArF Laser Components

**Table 1:** Technical Data of Standard ArF Laser Components

Coating/Reflectance Fluoride Coating	Substrate	Damage Threshold*	Lifetime Test
AR (0°, 193 nm) R < 0.25 %	CaF <sub>2</sub>	4 – 5 J/cm <sup>2</sup>	10 <sup>8</sup> pulses, no damage**
AR (0°, 193 nm) R < 0.25 %	Fused Silica	2 – 3 J/cm <sup>2</sup>	
PR (0°, 193 nm) R = 25 %	CaF <sub>2</sub>	3 – 4 J/cm <sup>2</sup>	10 <sup>10</sup> pulses, no damage**
PR (0°, 193 nm) R = 50 %	CaF <sub>2</sub>	2 – 3 J/cm <sup>2</sup>	10 <sup>10</sup> pulses**
HR (0°, 193 nm) R > 97 % (typically R > 98 %)	CaF <sub>2</sub>	2 – 3 J/cm <sup>2</sup>	10 <sup>10</sup> pulses**, no damage 4 × 10 <sup>9</sup> pulses***, no damage
HRu (45°, 193 nm) R > 97 % (typically R > 98 %)	CaF <sub>2</sub>	2 – 3 J/cm <sup>2</sup>	

\* 1000-on-1, pulse duration 14 ns; measurements were performed at Laser Labor Göttingen, Laser Zentrum Hannover and at Friedrich Schiller University Jena  
 \*\* Energy density 55 mJ/cm<sup>2</sup>, repetition rate 1 kHz, pulse duration 15 ns; tested at COHERENT AG, München  
 \*\*\* Energy density 80 mJ/cm<sup>2</sup>, repetition rate 1 kHz, pulse duration 12 ns; tested at COHERENT AG, München

## Components for the Fourth Harmonic of Ti:Sapphire Lasers

Mirrors and separators for the 4<sup>th</sup> harmonic of Ti:Sapphire lasers in the wavelength range around 200 nm are produced by coating techniques which were developed for ArF laser coatings. For more information please see page 62 f.

# KrF, XeCl, XeF Lasers (248 nm, 308 nm, 351 nm)

## Cavity Mirrors

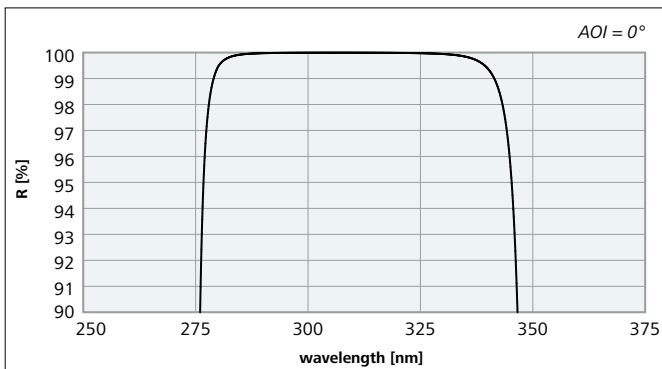


Figure 1: Reflectance spectrum of a 308 nm cavity mirror

- Oxide coatings for high mechanical stability
- Coatings can be produced by IAD, magnetron sputtering or IBS

## Fluorine Resistant Cavity Mirrors

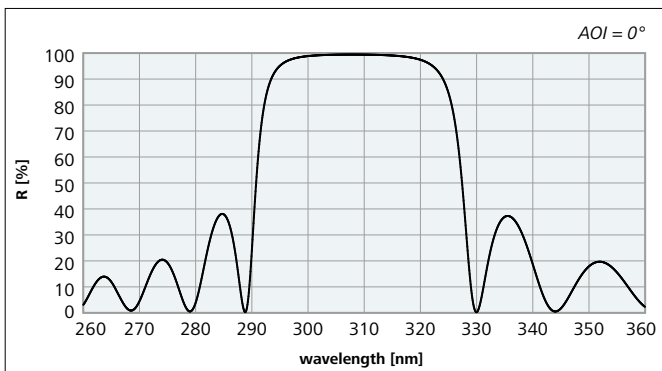


Figure 2: Reflectance spectrum of a fluoride KrF cavity mirror

- Fluoride coatings and CaF<sub>2</sub> substrates for high stability against fluorine and chlorine
- Laser mirrors with R > 98 % at 248 nm, 308 nm and 351 nm

## Output Couplers

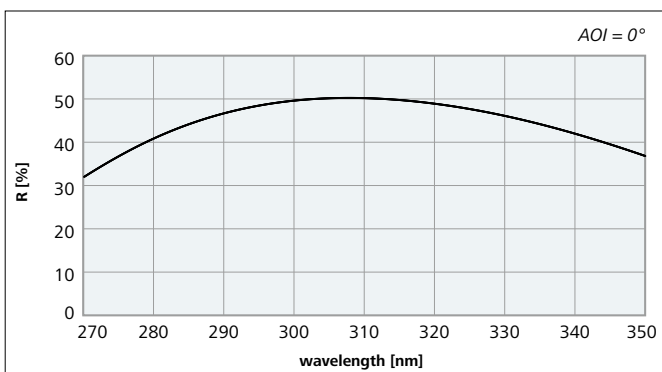
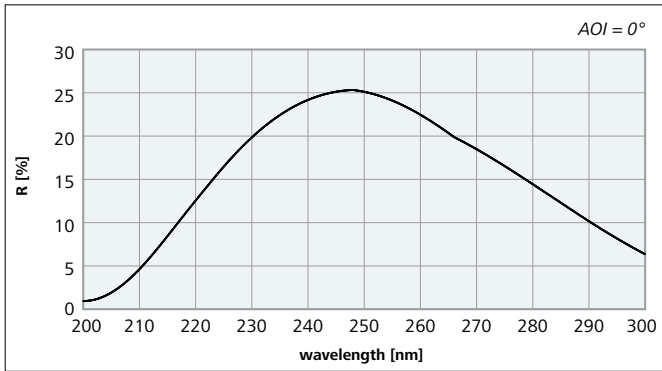


Figure 3: Reflectance spectrum of an output coupler with  $R(0^\circ, 308 \text{ nm}) = 50 \% \pm 3 \%$

- PR coatings with tolerances of
  - ± 2 % for R = 10 % ... 30 %
  - ± 3 % for R = 30 % ... 75 %
  - ± 2 % for R = 75 % ... 90 %
  - and ± 1 % for R > 90 %

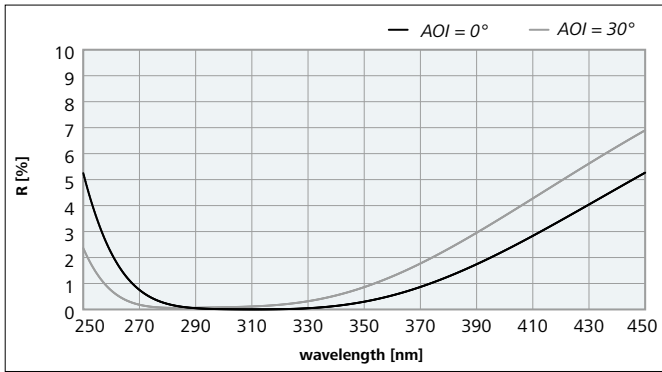
**Fluorine Resistant Output Couplers**



**Figure 4:** Reflectance spectrum of a fluoride output coupler with  $R(0^\circ, 248 \text{ nm}) = 25 \% \pm 3 \%$

- PR coatings with tolerances of:  
 $\pm 2 \%$  for  $R = 10 \% \dots 20 \%$   
 $\pm 3 \%$  for  $R = 20 \% \dots 75 \%$   
and  $\pm 2 \%$  for  $R = 75 \% \dots > 90 \%$

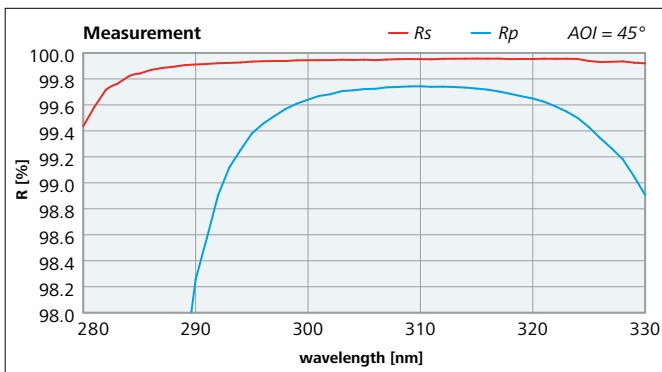
**Windows and Lenses**



**Figure 5:** Reflectance spectra of an AR coating for 308 nm and  $AOI = 0^\circ - 30^\circ$

- High quality mirror substrates, windows and lenses of Fused Silica

**Turning Mirrors**

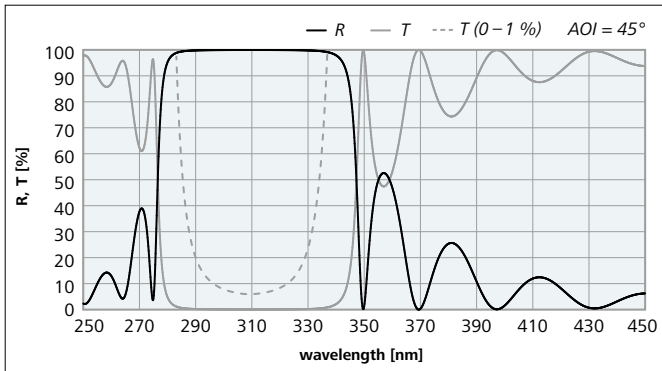


**Figure 6:** Reflectance spectra of a turning mirror for 308 nm produced by IBS (Reflectance measurement in s- and p-polarization by CRDS)

**Table 1:** Reflectance of Turning Mirror

Coating	R (AOI = 0°)	Rs (AOI = 45°)	Rp (AOI = 45°)
248 nm IAD	> 99.0 %	> 99.5 %	> 99.0 %
248 nm sputtering	> 99.7 %	> 99.8 %	> 99.6 %
308 nm IAD	> 99.7 %	> 99.8 %	> 99.5 %
308 nm sputtering	> 99.9 %	> 99.9 %	> 99.7 %
351 nm IAD	> 99.9 %	> 99.9 %	> 99.7 %
351 nm sputtering	> 99.95 %	> 99.95 %	> 99.9 %

## Attenuators



**Figure 7:** Transmittance spectrum of a sputtered attenuator for 308 nm with exactly adjusted and thermally stable transmittance of  $T = 0.08\%$  at  $AOI = 45^\circ$  (unpolarized light)

## LIDT and Lifetime Data

**Table 2:** LIDT of Oxide Coatings

Coating	LIDT* [J/cm <sup>2</sup> ]
HR (0°, 248 nm) IAD	10 J/cm <sup>2</sup> (1-on-1) 5 J/cm <sup>2</sup> (1000-on-1)
HR (45°, 248 nm) IAD	10 J/cm <sup>2</sup> (1-on-1)

\* Measurements were performed at Laser Labor Göttingen and at Friedrich-Schiller-University Jena

**Table 3:** Lifetime of Fluoride Coatings

Coating	Lifetime
HR (0°, 248 nm)	$2 \times 10^8$ pulses*
PR (0°, 248 nm) = 50 %	$2 \times 10^8$ pulses*
AR (0°, 248 nm)	$2 \times 10^8$ pulses**
HR (0°, 308 nm)	$2 \times 10^8$ pulses**
HR (0°, 351 nm)	$2 \times 10^8$ pulses**
PR (0°, 351 nm) = 25 %	$2 \times 10^8$ pulses**

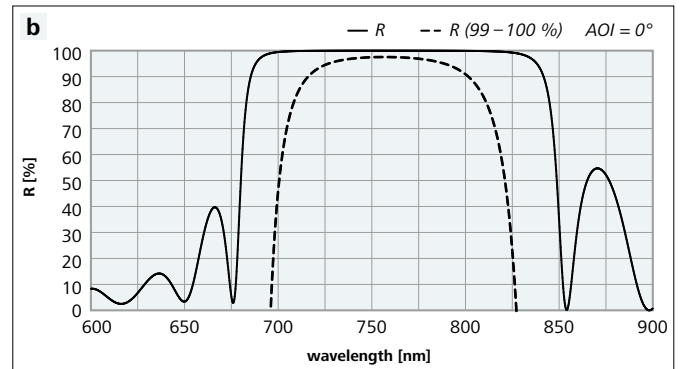
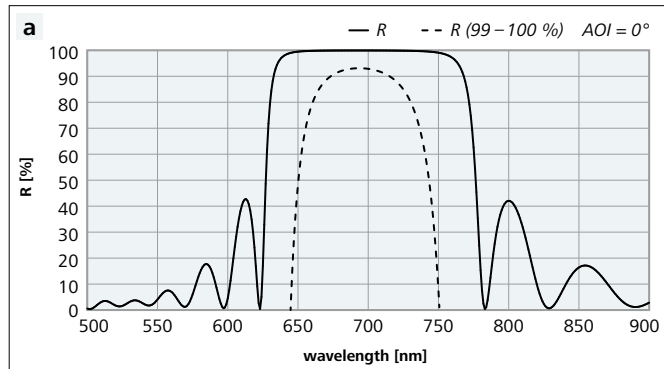
\* Energy density: 100 mJ/cm<sup>2</sup>, repetition rate: 100 Hz, pulse duration: 15 ns; tested at COHERENT AG, München  
 \*\* Energy density: 55 mJ/cm<sup>2</sup>, repetition rate: 100 Hz, pulse duration: 15 ns; tested at COHERENT AG, München

## Ruby and Alexandrite Lasers (694 nm, 755 nm)

Ruby and alexandrite lasers are especially used for medical laser applications and work at 694 nm and 755 nm, respectively. LAYERTEC offers a wide range of laser optics for both wavelengths with high laser-induced damage thresholds and long lifetimes. Besides typical combinations with wavelengths for the alignment of the optical system (e.g. 694 nm + 633 nm), a special feature of LAYERTEC products is the variety of combinations with other common wavelengths used for medical applications in the same device, but from different laser sources (e.g. 532 nm + 694 nm).

The coatings introduced here are optimized for high LIDT values, but not for extreme spectral bandwidth, GD or GDD. Please add a remark like "for ruby lasers" or "for alexandrite lasers" to your optics inquiry to avoid any mix-up with optics for Ti:Sapphire lasers which may also be specified for 694 nm or 755 nm but which show significantly lower LIDT values.

### Cavity Mirrors



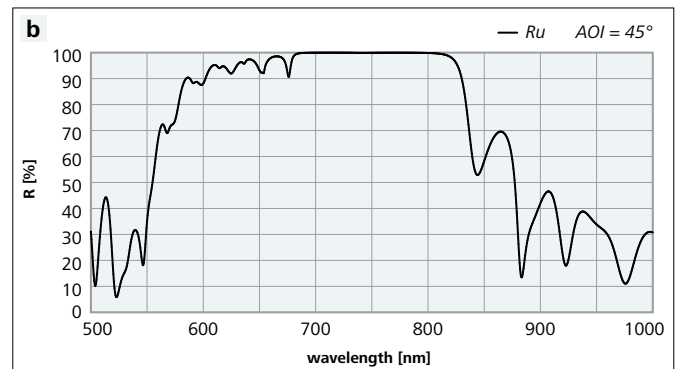
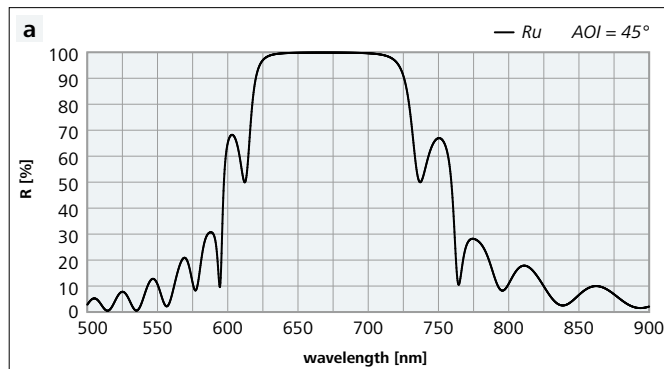
**Figure 1:** Reflectance spectra of cavity mirrors for:  
**a)**  $R(0^\circ, 694 \text{ nm}) > 99.9 \%$   
**b)**  $R(0^\circ, 755 \text{ nm}) > 99.9 \%$

- Reflectance:  $R > 99.8 \%$  ...  $R > 99.9 \%$  at  $\text{AOI} = 0^\circ$

#### LIDT Info

800 MW/cm<sup>2</sup>, 694 nm, 35 ns

### Turning Mirrors

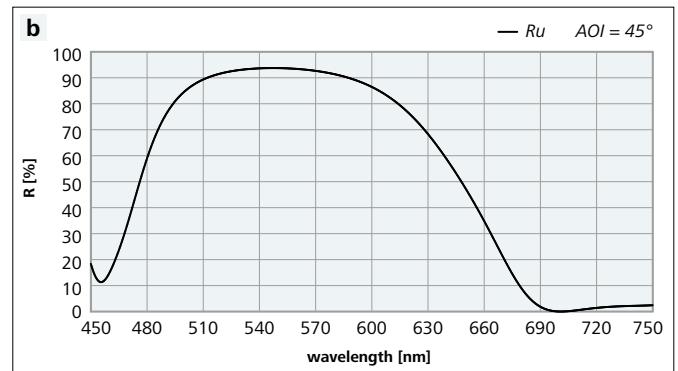
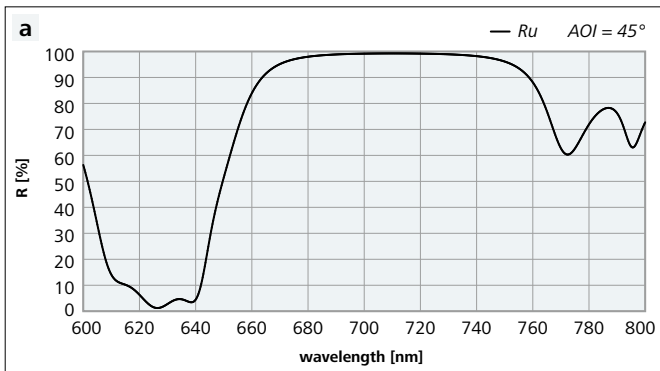


**Figure 2:** Reflectance spectra of turning mirrors for:  
**a)**  $Ru(45^\circ, 694 \text{ nm}) > 99.8 \%$  +  $Ru(45^\circ, 633 \text{ nm}) > 95 \%$   
**b)**  $Ru(45^\circ, 755 \text{ nm}) > 99.8 \%$  +  $Ru(45^\circ, 633 - 650 \text{ nm}) > 95 \%$

#### LIDT Info

800 MW/cm<sup>2</sup>, 694 nm, 35 ns

## Beam Combiners



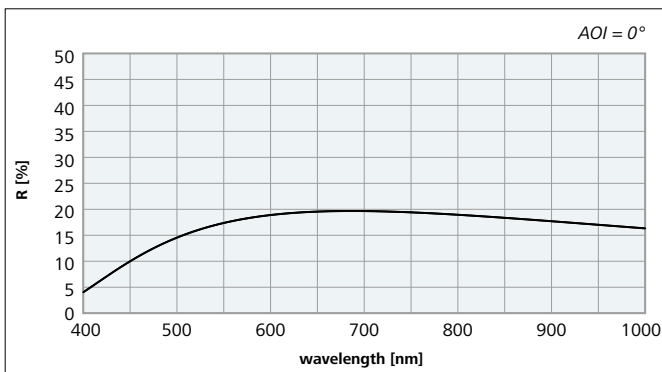
**Figure 3:** Reflectance spectra of special beam combiners for 694 nm and 633 nm:

**a)**  $PR(45^\circ, 694 \text{ nm}) = 99.0 \% \pm 0.3 \%$  +  $Ru(45^\circ, 633 \text{ nm}) < 35 \%$

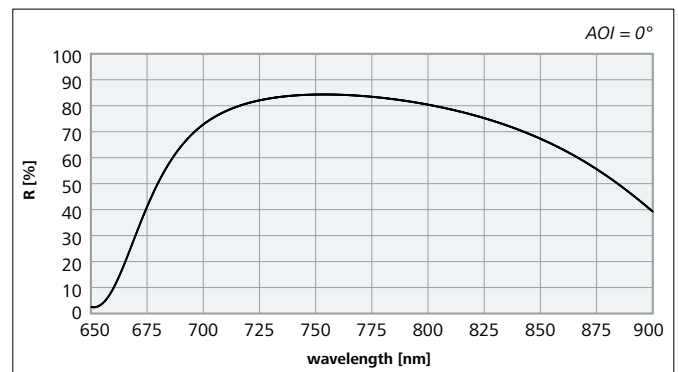
**b)**  $Ru(45^\circ, 630 - 640 \text{ nm}) > 35 \%$  +  $Rp(45^\circ, 694 \text{ nm}) < 0.3 \%$

- Precisely adjusted degree of reflectance by using sputtering technology
- Easy combination with alignment beam (e.g. at 635 nm)
- High performance and cost-optimized solutions with special designs

## Output Couplers



**Figure 4:** Reflectance spectrum of an output coupler for the ruby laser:  
 $PR(0^\circ, 694 \text{ nm}) = 20 \% \pm 2 \%$



**Figure 5:** Reflectance spectrum of an output coupler for the alexandrite laser:  
 $PR(0^\circ, 755 \text{ nm}) = 85 \% \pm 2 \%$

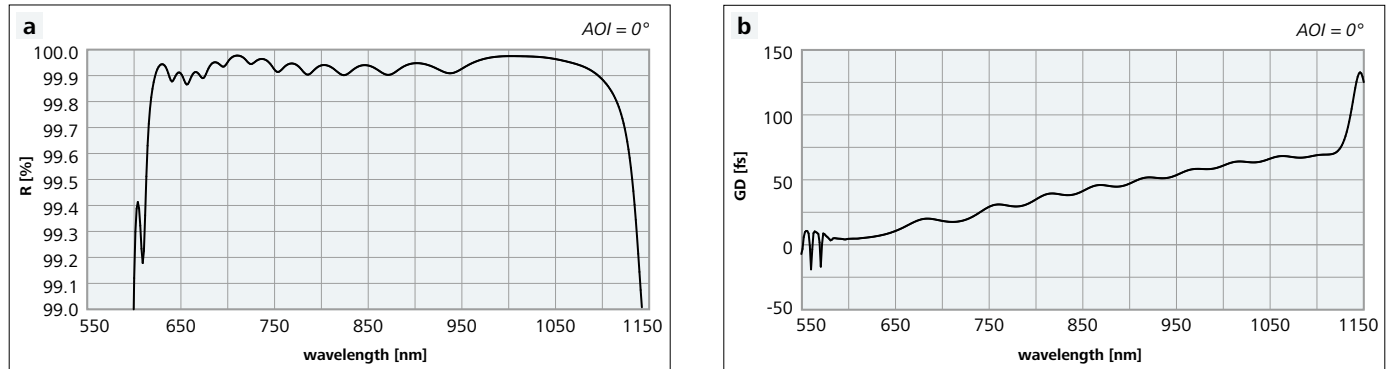
- Output couplers with precisely adjusted degree of reflectance
- AR coatings for a single wavelength with a residual reflectance of  $R < 0.2 \%$  on the rear side of output couplers as well as on both sides of lenses and windows made of Fused Silica

## Ti:Sapphire Lasers operated with ns-Pulses (550 – 1100 nm)

LAYERTEC offers a wide range of optical components for Ti:Sapphire lasers which operate with ns-pulses. Please note that all of these components are optimized for smooth group delay (GD) spectra in order to achieve wide tuning ranges. However, these components are not optimized for group delay dispersion (GDD). Such optics are necessary for fs-pulses and they will be introduced on page 37 ff.

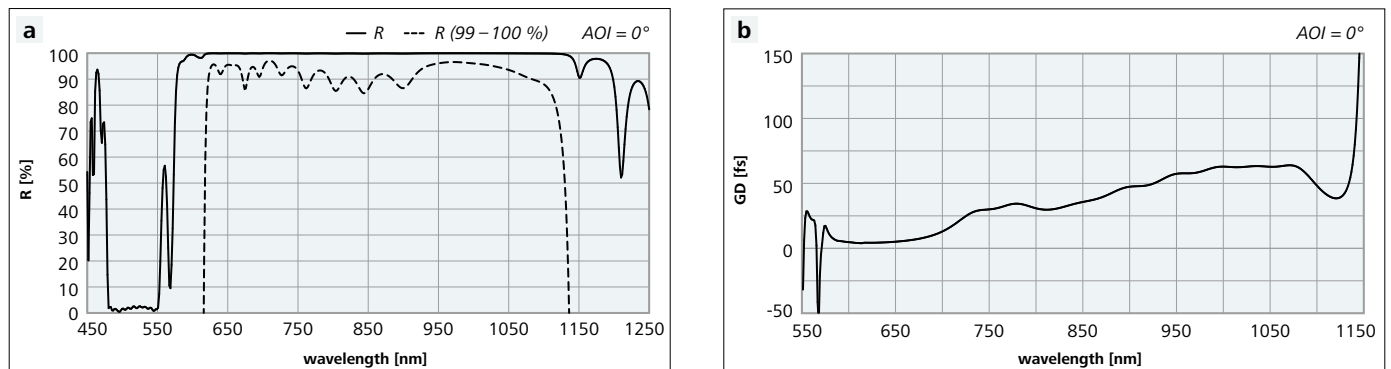
Please note that broadband optics for Ti:Sapphire lasers cannot be used for the radiation of ruby or alexandrite lasers, although they are specified for 694 nm or 755 nm, respectively. Ruby and alexandrite lasers require special high power coatings. For such special coatings please see page 12 f.

### Cavity Mirrors



**Figure 1:** Reflectance and GD-spectra of a broadband laser mirror  
**a)** Reflectance vs. wavelength  
**b)** GD vs. wavelength

### Pump Mirrors



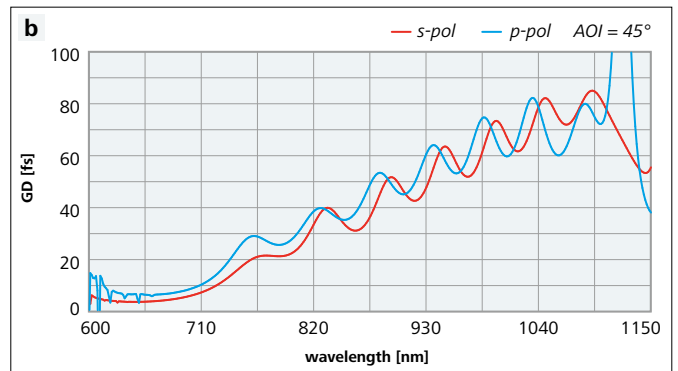
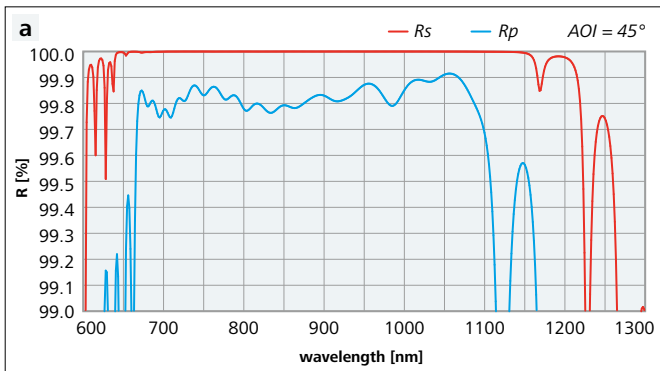
**Figure 2:** Reflectance spectra of a broadband pump mirror  
**a)** Reflectance vs. wavelength  
**b)** GD vs. wavelength

### Special Features

- Very high reflectance of the mirrors:  $R > 99.9\%$ , depending on bandwidth  $R > 99.98\%$  may also be achieved
- Spectral tolerance:  $\pm 1\%$
- Center wavelength, bandwidth and reflectance of partial reflectors according to customer specification

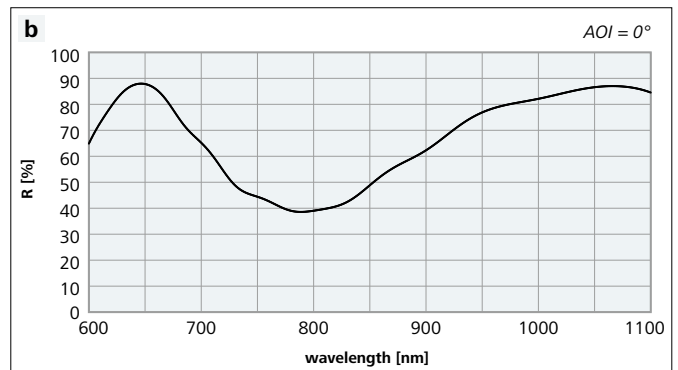
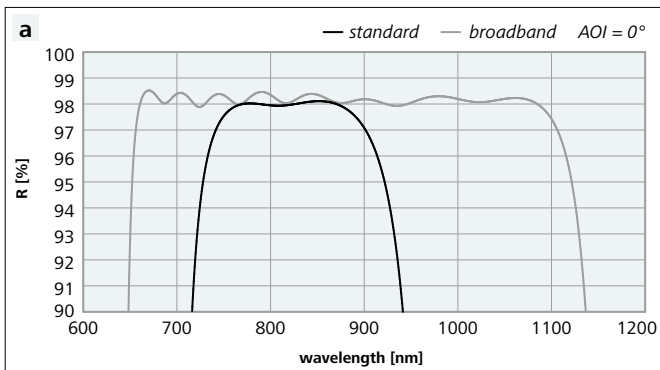


## Turning Mirrors

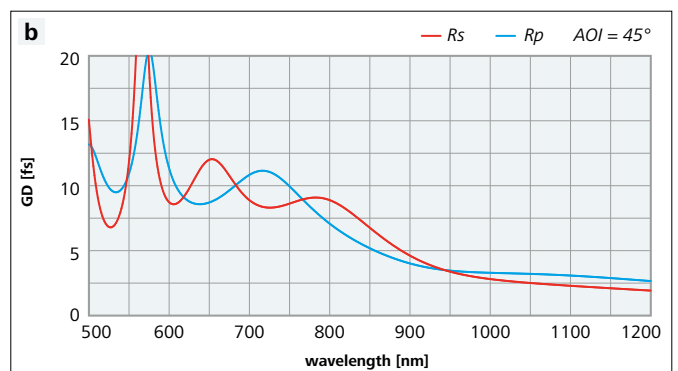
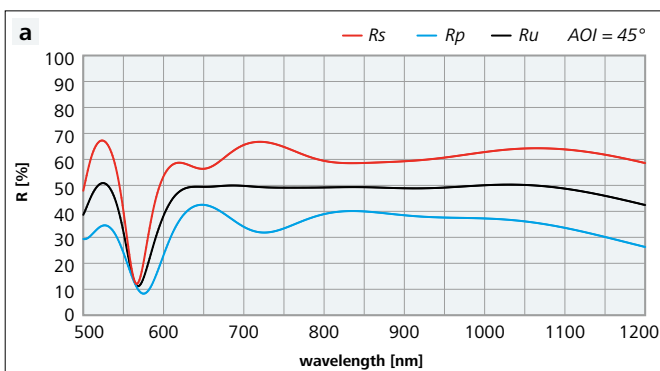


**Figure 3:** Reflectance and GD spectra of a broadband turning mirror  
a) Reflectance vs. wavelength  
b) GD vs. wavelength

## Output Couplers



**Figure 4:** Reflectance spectra of several types of output couplers  
a) Standard and broadband output coupler  
b) Output coupler with a special reflectance profile which enables the compensation of the amplification characteristics of the laser; see also:  
B. Jungbluth, J. Wueppen, J. Geiger, D. Hoffmann, R. Poprawe: "High Performance, Widely Tunable Ti:Sapphire Laser with Nanosecond Pulses"  
in: "Solid State Lasers XV: Technology and Devices", Proc. of SPIE Vol. 6100, San Jose 2006



**Figure 5:** Reflectance and GD spectra of a broadband beam splitter with PRu (45°, 650 – 1050 nm) = 50 % ± 3 %  
a) Reflectance vs. wavelength  
b) GD vs. wavelength

## Tolerances

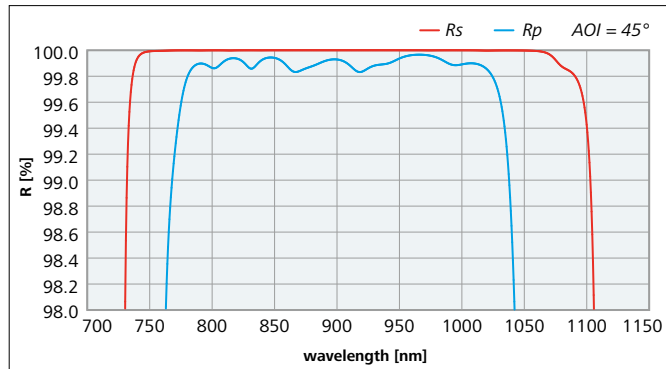
- Standard output couplers (120 – 150 nm bandwidth):
  - ±2.5 % for R = 10 ... 70 %
  - ±1.5 % for R = 70 ... 90 %
  - ±0.75 % for R = 90 ... 95 %
  - ±0.5 % for R = 95 ... 98 %
  - ±0.25 % for R > 98 %

- Broadband output couplers (200 – 600 nm bandwidth):
  - ±3 % for R = 10 ... 70 %
  - ±2 % for R = 70 ... 90 %
  - ±1 % for R = 90 ... 95 %
  - ±0.5 % for R = 95 ... 98 %

## Diode Lasers (620 – 680 nm, 808 – 990 nm)

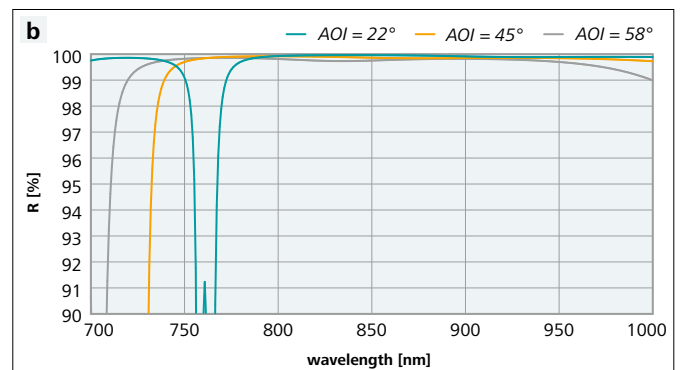
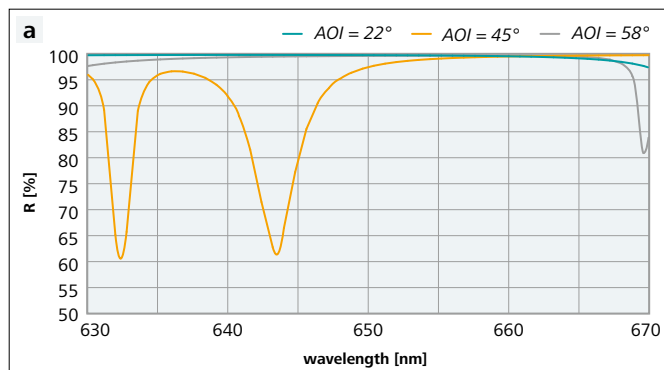
Diode lasers are widely used for measurement applications, as alignment lasers, for pumping of solid-state lasers and for direct material processing. Diode lasers do not require external resonator optics and are mostly coupled to fibers. Many applications require high quality beam steering optics such as beam combiners or scanning mirrors which are shown on the following pages. For more information on pump mirrors for solid-state lasers and combiners for diode lasers please see also page 18 ff. and 78 f.

### Turning Mirrors



**Figure 1:** Reflectance spectra of a broadband turning mirror which can be used for all diode lasers between 808 nm and 980 nm (AOI = 45°, s- and p-polarization)

### Scanning Mirrors

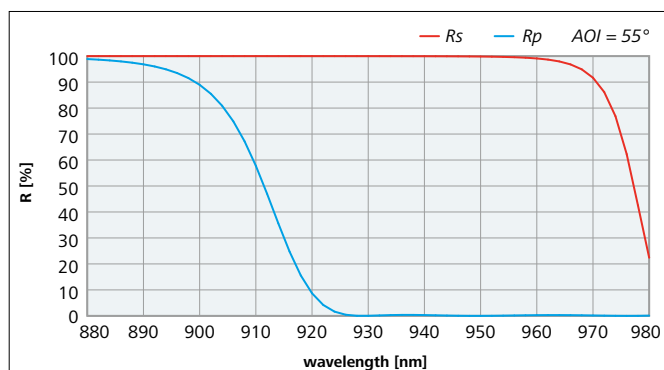


**Figure 2:** Reflectance spectra of a scanning mirror for diode lasers between 805 and 940 nm combined with  $R > 50\%$  between 630 and 670 nm (alignment laser): HRu (22° – 58°, 805 – 940 nm)  $> 99.3\%$  + Ru (22° – 58°, 630 – 670 nm)  $> 50\%$

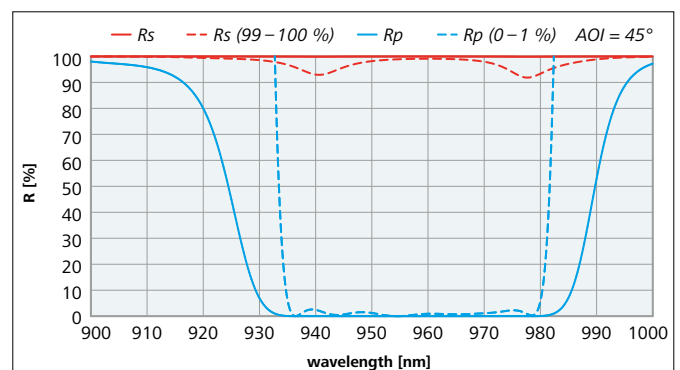
- a)** Wavelength range of the alignment laser (630 – 670 nm)
- b)** Wavelength range of the high power diode laser (808 – 980 nm)

- Scanning mirrors with other specifications on request
- For more information and examples about scanning mirrors please see page 76 f. and 87 ff.

### Thin Film Polarizers



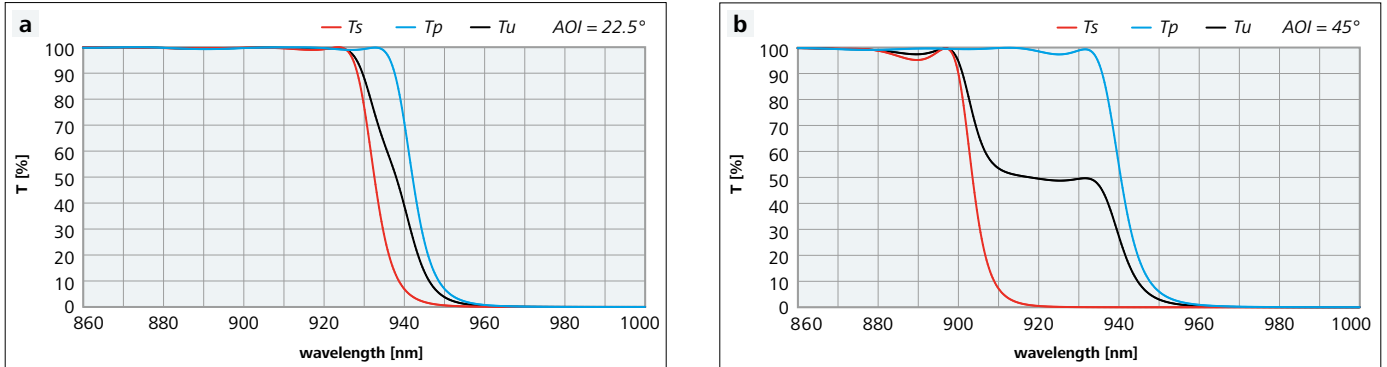
**Figure 3:** Reflectance spectra of a thin film polarizer for 940 nm, AOI = 55°



**Figure 4:** Reflectance spectra of a broadband thin film polarizer for 940 – 970 nm:  
 HRs (45°, 940 – 970 nm)  $> 99.9\%$   
 + Rp (45°, 940 – 970 nm)  $< 1\%$

- Thin film polarizers are especially useful for polarization coupling of high power laser diodes
- For high power 940 nm radiation we recommend to use SUPRASIL 300®, SUPRASIL 3001/3002® or Corning 7979® as substrate material because standard Fused Silica shows an absorption band around this wavelength (see page 138 to 140)

### Conventional Steep Edge Combiners for Diode Lasers

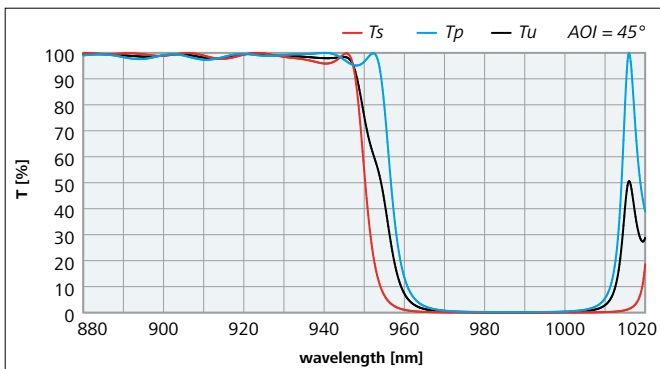


**Figure 5:** Transmittance spectra of conventional steep edge filters  $HR(980\text{ nm}) > 99.9\%$  +  $R(915\text{ nm}) < 5\%$  which are used as combiners for pump laser diodes at 915 nm and 980 nm:

- a)**  $HR_{s,p}(22.5^\circ, 980\text{ nm}) > 99.9\%$  +  $Rs,p(22.5^\circ, 915\text{ nm}) < 2\%$   
**b)**  $HR_{s,p}(45^\circ, 980\text{ nm}) > 99.9\%$  +  $Rp(45^\circ, 915\text{ nm}) < 2\%$

- At  $AOI = 22.5^\circ$  the conventional steep edge filter separates 915 nm and 980 nm for p-, s-, and unpolarized light
- To preserve the steep edge at  $AOI = 45^\circ$  the radiation must be polarized and only one polarization can be used. For unpolarized light the slope of the edge can change significantly.

### Special Steep Edge Combiners for Unpolarized Light



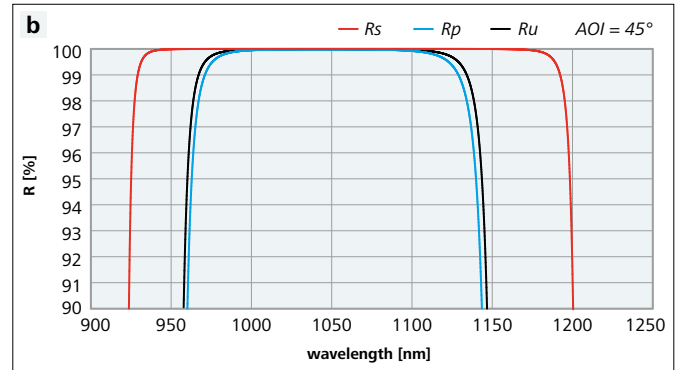
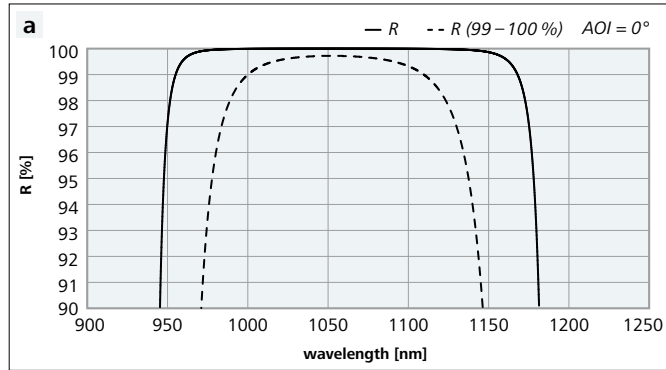
**Figure 6:** Transmittance spectra of a special steep edge filter  $HRu(45^\circ, 980\text{ nm}) > 99.8\%$  +  $Ru(45^\circ, 940\text{ nm}) < 3\%$

- Filters of this type can be used as separators or combiners for s- and p-polarized light even at  $45^\circ$  incidence
- The cut-on/cut-off edges for the two polarizations only show a spectral separation of about 10 nm
- Consequently, these filters can be applied as combiners for unpolarized light of 940 nm and 980 nm diodes at  $AOI = 45^\circ$

# High Power Lasers on the Basis of Yb- and Nd-doped Materials (1020 – 1080 nm)

Yb- and Nd-doped high power lasers are commonly used in material processing as well as measurement applications. Thin disk, slab and fiber lasers were developed to achieve high cw-output power and excellent beam quality. They can also be operated as high power lasers in the ns to fs range.

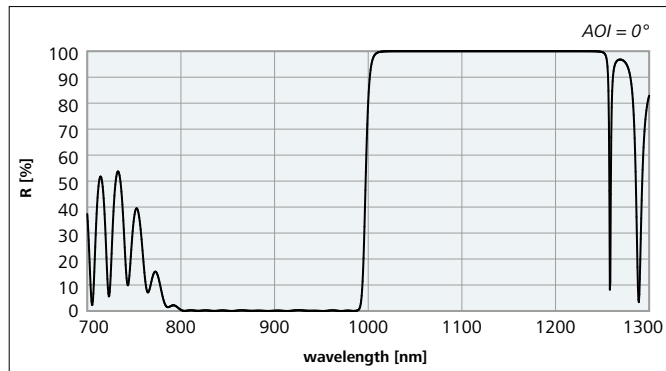
## Mirrors



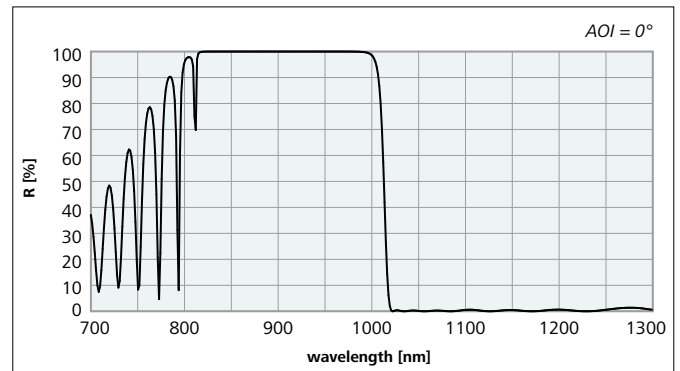
**Figure 1:** Reflectance spectra of HR mirrors for 1030 nm  
 a) Cavity mirror  
 b) Turning mirror

LAYERTEC has developed different coating designs for handling extraordinarily high power densities or energy densities in cw lasers or pulsed lasers, respectively. The designs are optimized either for cw radiation, ns pulses or ps pulses.

## Edge Filters and Pump Mirrors



**Figure 2:** Reflectance spectrum of a steep edge short pass filter



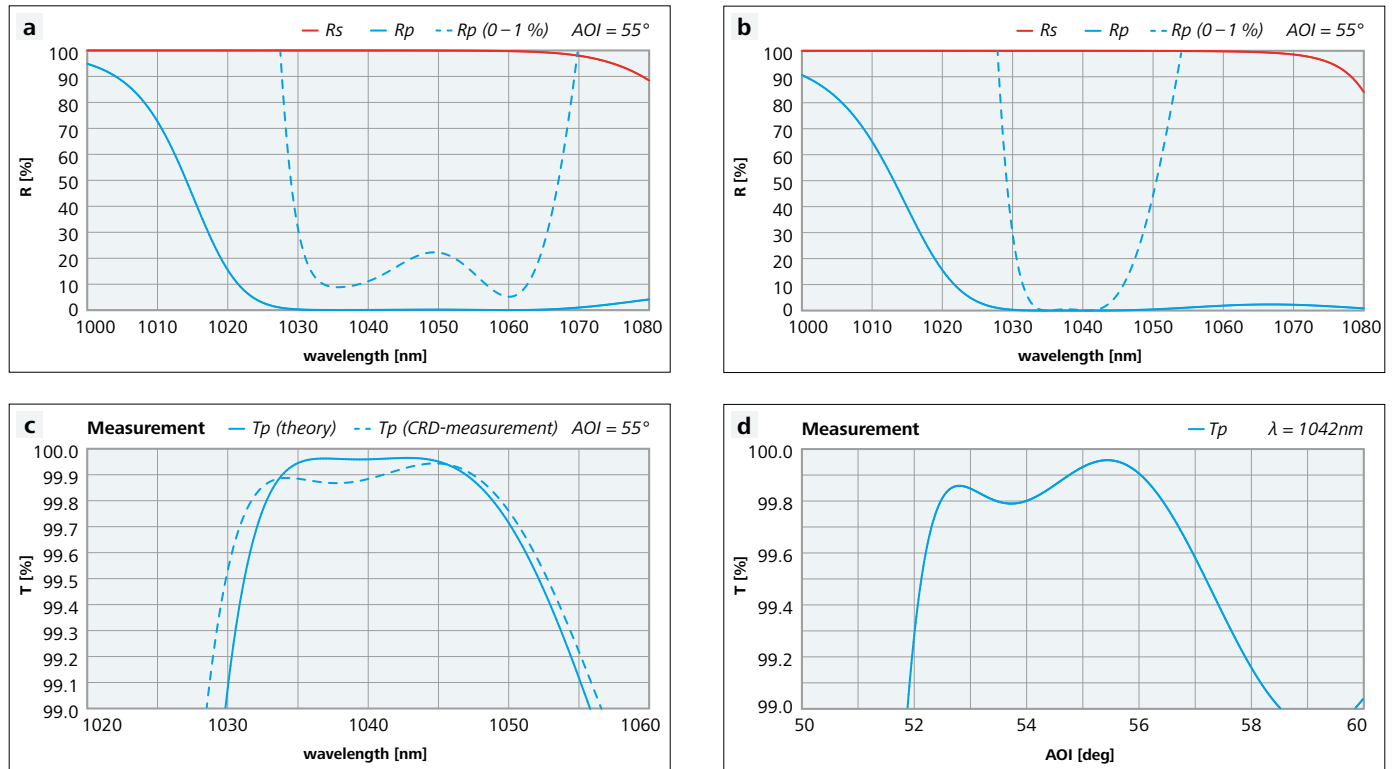
**Figure 3:** Reflectance spectrum of a steep edge long pass filter  
 HR (0°, 915 – 980 nm) > 99.8 % + R (0°, 1030 – 1200 nm) < 3 %  
 for use as output mirror of a fiber laser (rear side AR coated)

## Special Features

- Short pass filters with a very steep edge which are utilized as a pump mirror for solid-state lasers based on Yb-doped materials, e.g. Yb:YAG, Yb:KGW or Yb-doped fiber
- Also useful for Nd-doped and Yb-Nd-co-doped materials

## Thin Film Polarizers

Thin film polarizers are key elements for regenerative amplifiers in ns- and ps-lasers. LAYERTEC optimizes its polarizer designs for high laser-induced damage thresholds (LIDT). Figure 4 shows examples of a broadband polarizer with  $R_p < 0.2\%$  for  $AOI = 55^\circ$  within a bandwidth of 25 nm in the wavelength range of Yb-doped fiber lasers (figure 4a) and a narrowband polarizer which is optimized for very low  $R_p$  values at a single wavelength (figure 4b). Figure 4c shows a comparison of the calculated transmittance spectrum for p-polarized light and a measurement in a CRD set-up. Figure 4d shows  $T_p$  vs.  $AOI$  for the same polarizer (measured at 1042 nm). These measurements prove that  $T_p > 99.9\%$  can be achieved by angle adjustment. This is important especially for intra cavity applications.



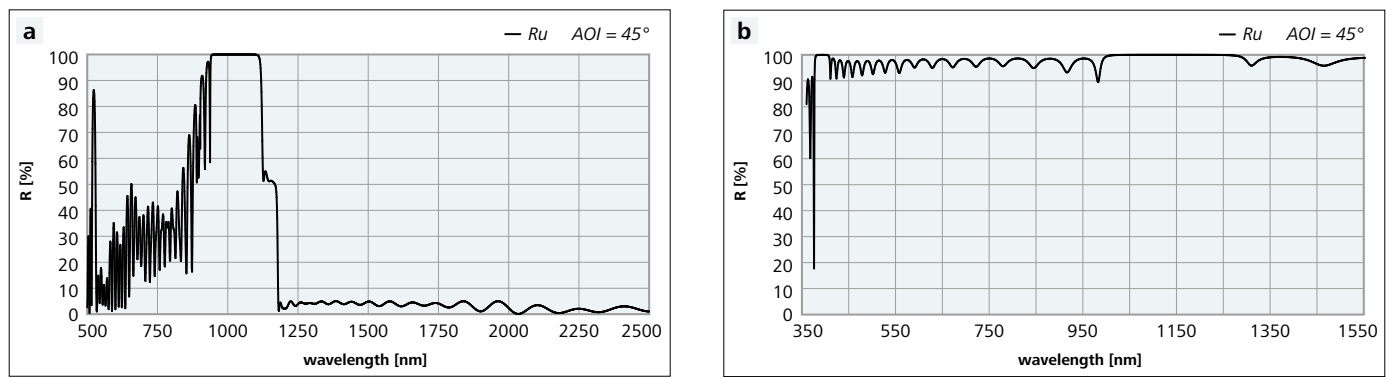
**Figure 4:** Reflectance and transmittance spectra of thin film polarizers (TFPs)

- a)** Reflectance spectra for s- and p-polarized light of a broadband thin film polarizer showing a bandwidth of 25 nm with  $R_p < 0.2\%$  ( $AOI = 55^\circ$ )
- b)** Reflectance spectra for s- and p-polarized light of a narrowband thin film polarizer which is optimized for very low  $R_p$  values and easy angle adjustment for the optimization of the polarizer performance ( $AOI = 55^\circ$ )
- c)** Calculated and measured transmittance spectra for p-polarized light of the narrowband thin film polarizer shown in figure 4b ( $AOI = 55^\circ$ ).  $T_p > 99.8\%$  is reached with a bandwidth of 15 nm and  $T_p > 99.9\%$  can be achieved within a bandwidth of 5 nm. The spectral position of this transmittance maximum can be adjusted to any wavelength between 1035 nm and 1045 nm by angle adjustment.
- d)** Transmittance spectrum  $T_p$  vs.  $AOI$  at 1042 nm measured at the polarizer shown in figure 4c

## Picosecond Lasers based on Yb-doped Materials

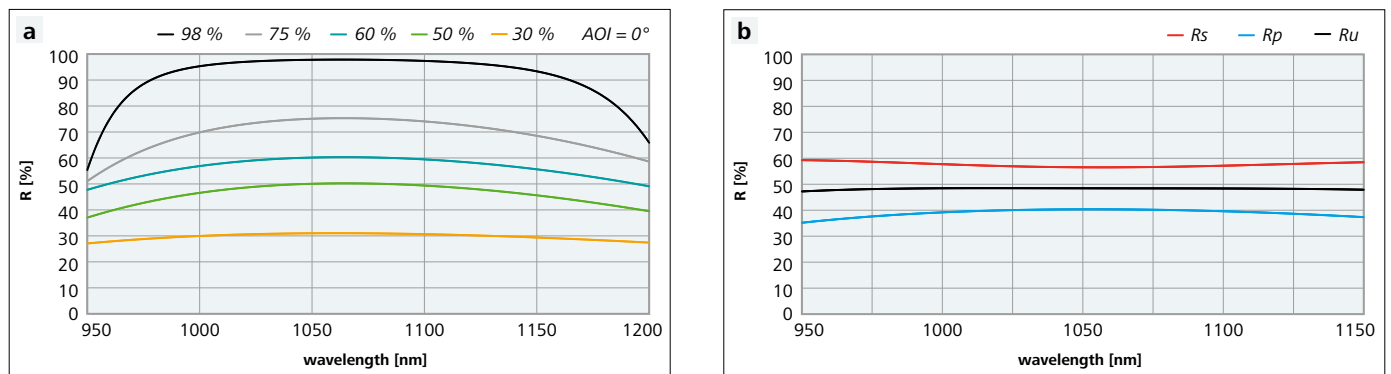
Picosecond laser optics require specially designed coatings to achieve high laser damage thresholds. For detailed information please see page 54 ff. For GTI mirrors which are often used for pulse compression from the ps range down to a few hundred fs please see page 64 ff.

Alignment and Process Monitoring



**Figure 5:** Reflectance spectra of turning mirrors with special features for alignment and process monitoring  
**a)** Turning mirror with low IR reflectance, i.e. high IR transmittance for process monitoring  
**b)** Silver based turning mirror with  $R_u(45^\circ, 1064 \text{ nm}) > 99.8 \%$  and with  $R_u > 80 \%$  for an alignment laser in the red spectral range

Beam Splitters and Output Couplers

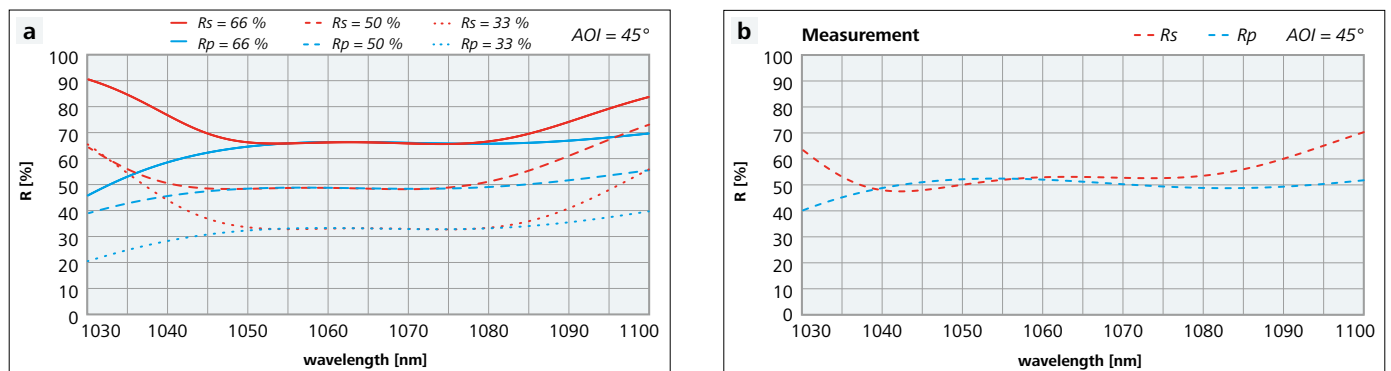


**Figure 6:** Reflectance spectra of output couplers and beam splitters (center wavelength 1064 nm)  
**a)** Output couplers with different degrees of reflectance  
**b)** Common 50:50 beam splitter for unpolarized light

• Beam splitters and output couplers can be produced with a precisely adjusted degree of reflectance:

- Common types:  
 $R_{s,p} > 95 \% \pm 0.5 \%$   
 $R_{s,p} = 80 \% \dots 95 \% \pm 1 \%$   
 $R_{s,p} = 10 \% \dots 80 \% \pm 2 \%$

Non Polarizing Beam Splitters



**Figure 7:** Non-polarizing beam splitters  
**a)** Calculated reflectance spectra of 3 types of non-polarizing beam splitters for  $AOI = 45^\circ$   
**b)** Measured reflectance spectra of the 50% beam splitter

• Beam splitters with  $R_s \approx R_p$  ( $|R_s - R_p| < 1.5 \%$ ) for  $AOI = 45^\circ$  and different degrees of reflectance:

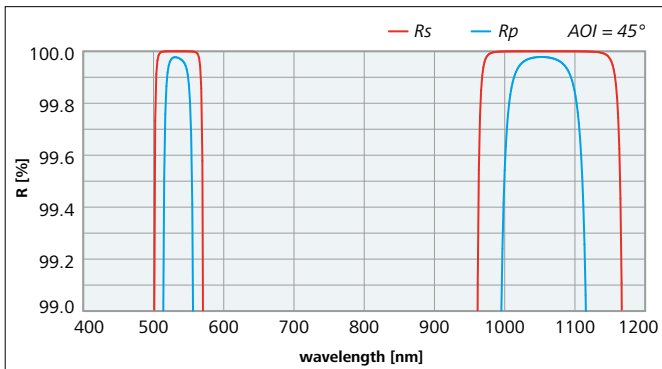
• All non-polarizing beam splitters with rear side AR:  
 $R_s \approx R_p \approx 0.6 \%$

- Common types:  
 $R_{s,p} = 66 \% \pm 1 \%$   
 $R_{s,p} = 50 \% \pm 2 \%$   
 $R_{s,p} = 33 \% \pm 3 \%$

# Second Harmonic of High Power Lasers on the Basis of Yb- and Nd-doped Materials (515 nm, 532 nm)

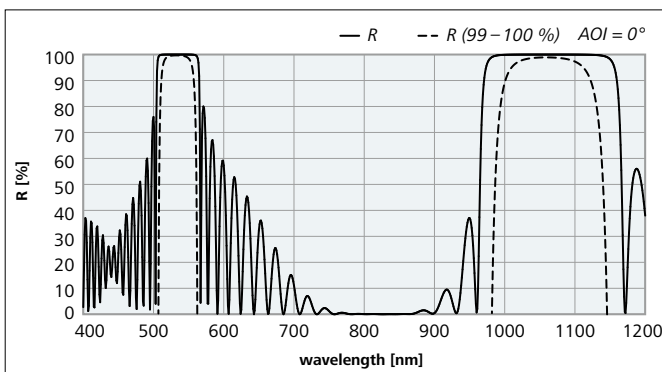
The harmonics of Yb- and Nd-based high power lasers are widely used material processing as well as for measurement applications. Moreover, the second harmonic of these lasers is often used as a pump source for Ti:Sapphire lasers. LAYERTEC offers a variety of optics for 532 nm: dual wavelength mirrors, separators, thin film polarizers and non-polarizing beam splitters, but also cavity optics for compact diode pumped lasers of different configurations. Coatings for 515 nm are available as well. All designs are calculated according to customer specifications.

## Dual Wavelength Turning Mirror

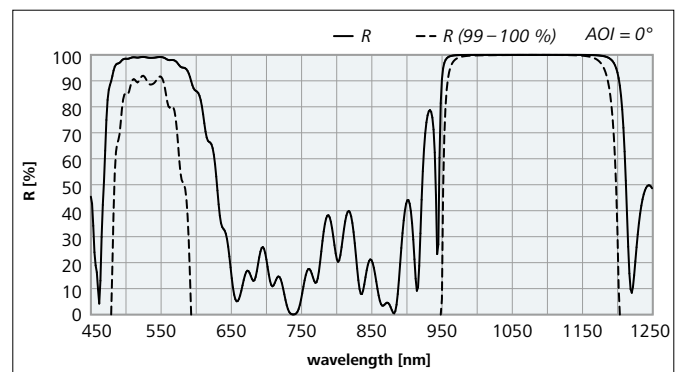


**Figure 1:** Reflectance spectra of a dual wavelength turning mirror  
 $HR_{s,p}(45^\circ, 532 + 1064 \text{ nm}) > 99.9 \%$

## Dual Wavelength Cavity Mirror

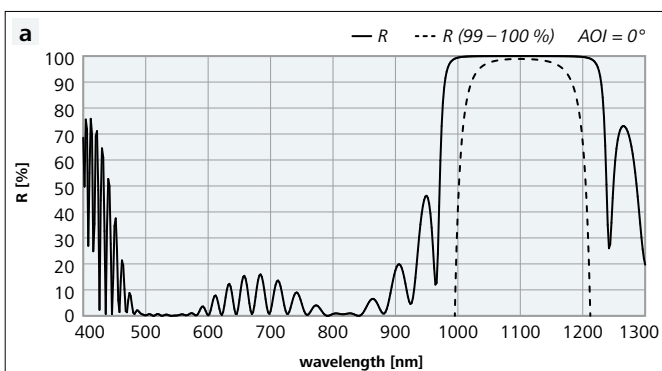


**Figure 2:** Reflectance spectra of a dual wavelength cavity mirror with high transmittance for the pump wavelength (808 nm)



**Figure 3:** Reflectance spectra of an HR mirror for 1064 nm with additional output coupler for 532 nm:  
 $HR(0^\circ, 1064 \text{ nm}) > 99.9 \%$  +  $R(0^\circ, 532 \text{ nm}) = 99 \%$   $\pm 0.3 \%$

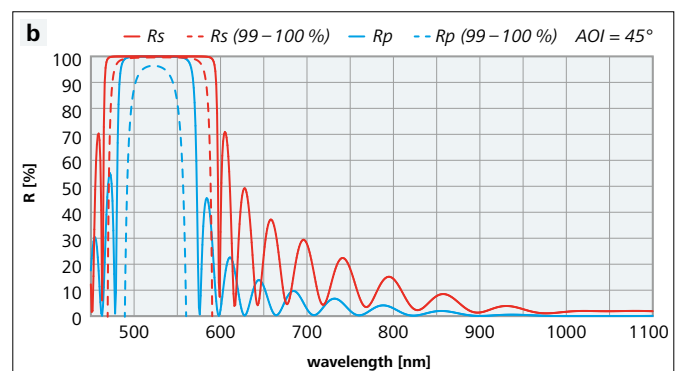
## Separators for the Second Harmonic and the Fundamental Wave



**Figure 4:** Reflectance spectra of separators for the second harmonic and the fundamental wavelength:

**a)**  $HR(0^\circ, 1064 \text{ nm}) > 99.9 \%$  +  $R(0^\circ, 532 + 808 \text{ nm}) < 3 \%$

**b)**  $HR_{s,p}(45^\circ, 515 + 532 \text{ nm}) > 99.8 \%$  +  $R_s(45^\circ, 1030 + 1064 \text{ nm}) < 5 \%$  +  $R_p(45^\circ, 1030 + 1064 \text{ nm}) < 2 \%$



Separators with different features are available according to customer specifications.

Thin Film Polarizers

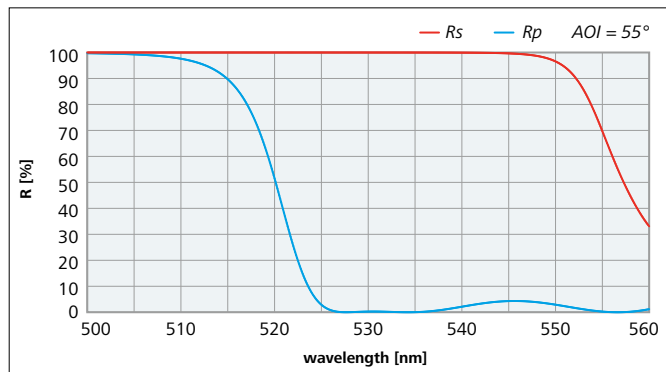


Figure 5: Reflectance spectra of a thin film polarizer for 532 nm

The transmittance of thin film polarizers for p-polarized light can be measured in-house with high accuracy using a modified Cavity Ring-Down set-up.

Non-Polarizing Beam Splitters

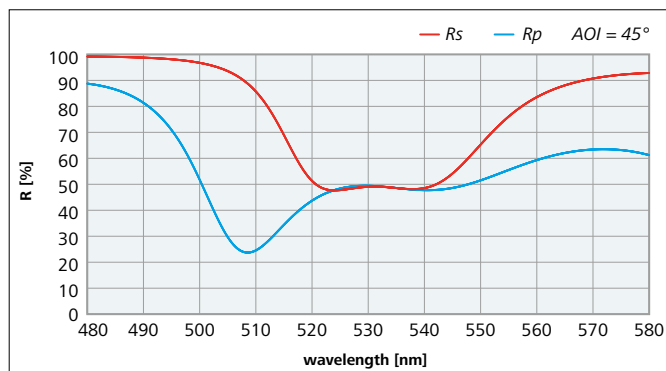


Figure 6: Reflectance spectra of a non-polarizing beam splitter for 532 nm with  $R_s = R_p = 50 \pm 2\%$  ( $|R_s - R_p| < 3\%$ )

Coating on Nonlinear Optical Crystals

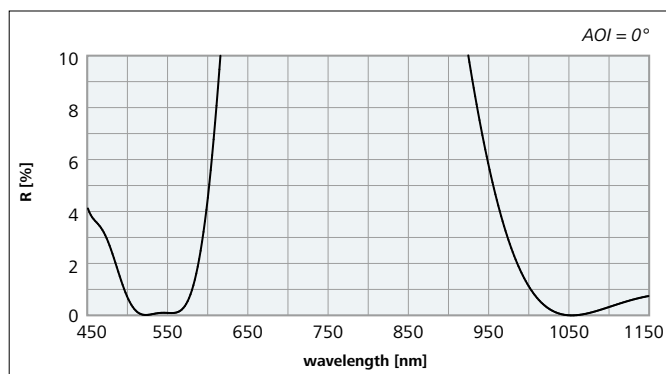


Figure 7: Reflectance spectrum of a dual wavelength antireflection coating on KTP for 532 nm and 1064 nm

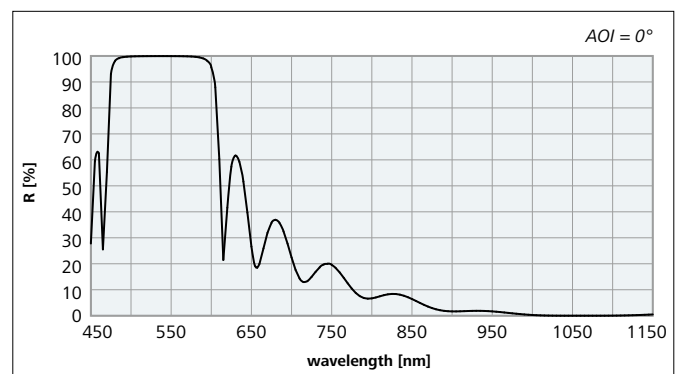


Figure 8: Reflectance spectrum of a dichroic mirror on KTP:  $HR(0^\circ, 532\text{ nm}) > 99.98\%$  +  $R(0^\circ, 1064\text{ nm}) < 0.2\%$  optimized for very high transmittance at 1064 nm

Nonlinear optical crystals are the key elements for frequency conversion. LAYERTEC offers a variety of coatings on crystals like KTP and lithium niobate. For more information about coatings on crystals see page 84 f.

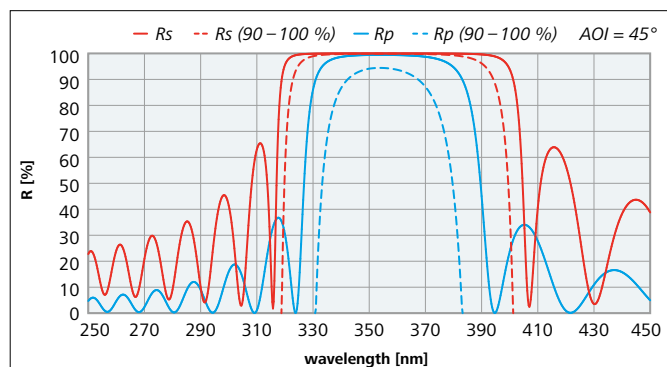


# Third Harmonic of High Power Lasers on the Basis of Yb- and Nd-doped Materials (343 nm, 355 nm)

## Standard Components

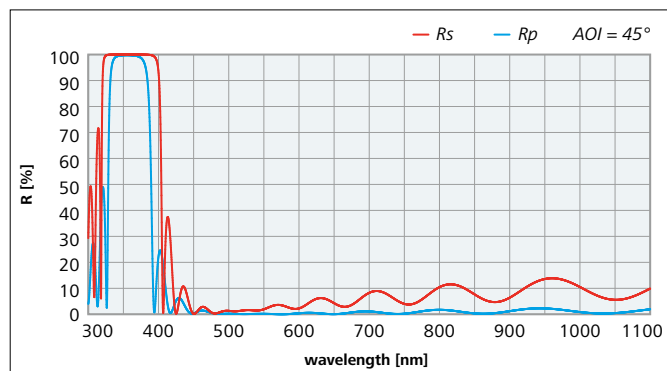
The third harmonic of Nd:YAG, Nd:YVO<sub>4</sub> and Yb:YAG lasers has gained importance in the field of material processing, for measurement applications and as pump source for optical parametric oscillators. LAYERTEC manufactures a wide range of optics for 355 nm: single and multiple wavelength mirrors, separators, thin film polarizers and antireflection coatings. The coating designs shown here are calculated for 355 nm, but designs for 343 nm are available as well. In general, the coating designs are optimized according to customer specifications.

## Turning Mirrors



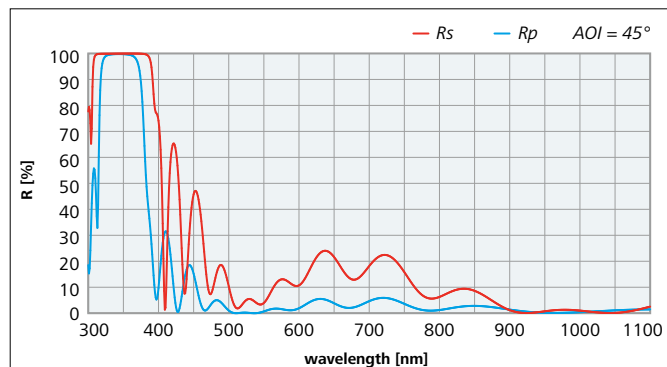
**Figure 1:** Reflectance spectra of a turning mirror:  
 HRs (45°, 355 nm) > 99.9 % + HRp (45°, 355 nm) > 99.5 %

## Standard Separators



**Figure 2:** Reflectance spectra of a standard separator reflecting the third harmonic and transmitting the second harmonic and the fundamental wave:  
 HRs (45°, 355 nm) > 99.9 % + HRp (45°, 355 nm) > 99.5 %  
 + Rp (45°, 532 + 1064 nm) < 2 %  
 + Rs (45°, 532 nm) < 5 % + Rs (45°, 1064 nm) < 10 %

## Special Separators



**Figure 3:** Reflectance spectra of a special separator optimized for low reflectance at 1064 nm:  
 HRs (45°, 355 nm) > 99.9 % + HRp (45°, 355 nm) > 99.5 %  
 + Rp (45°, 532 + 1064 nm) < 2 % + Rs (45°, 532 nm) < 5 %  
 + Rs (45°, 1064 nm) < 2 %

Windows and Lenses

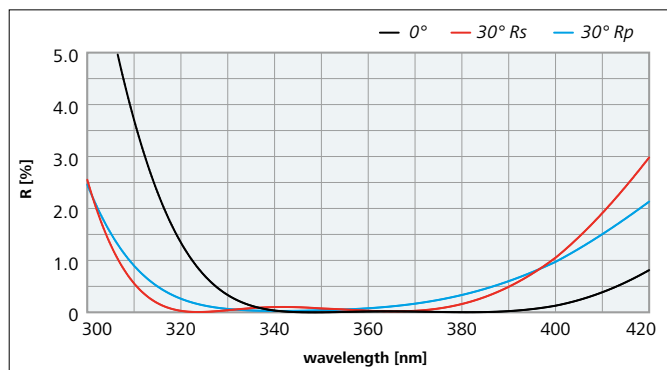


Figure 4: Reflectance spectra of a single wavelength AR coating for 355 nm optimized for AOI = 0°– 30°

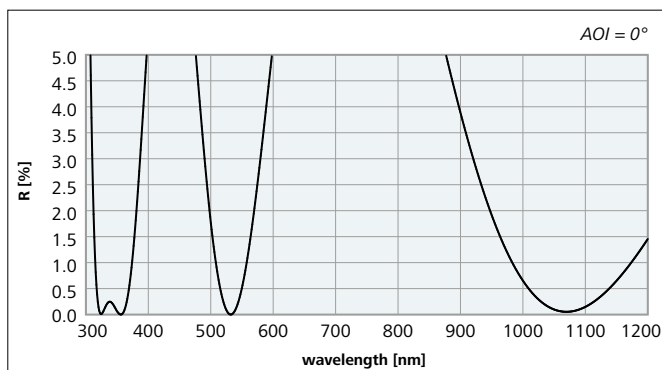


Figure 5: Reflectance spectrum of a triple wavelength antireflection coating on Fused Silica for 355 nm, 532 nm and 1064 nm

Sputtered Multiple Wavelength Mirrors

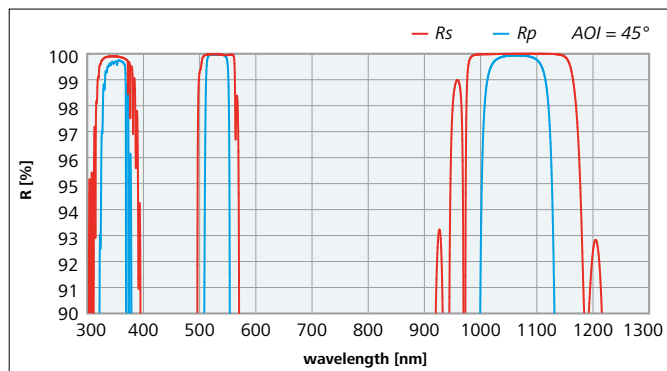


Figure 6: Reflectance spectra of a triple wavelength turning mirror for 355 nm, 532 nm and 1064 nm

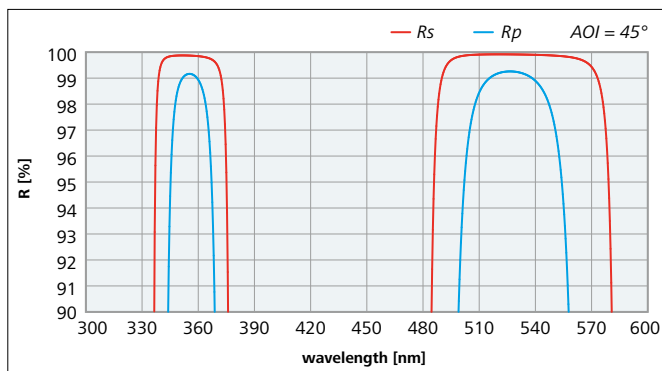


Figure 7: Reflectance spectra of a dual wavelength turning mirror for 355 nm and 532 nm

Sputtered Thin Film Polarizers

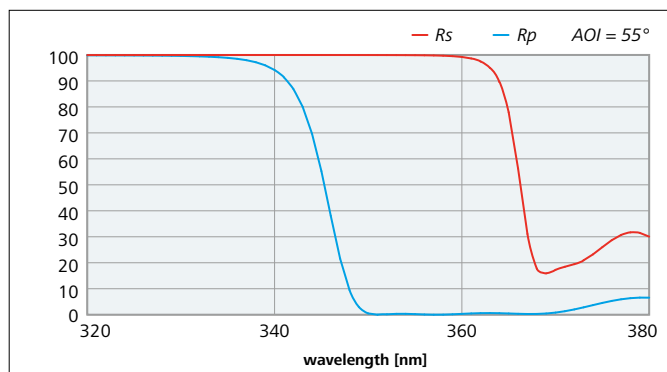


Figure 8: Reflectance spectra of a thin film polarizer for 355 nm: HRs (55°, 355 nm) > 99.5 % + Rp (55°, 355 nm) < 2 %

The transmittance of p-polarized light can be optimized by angle adjustment. Tilting the polarizer by  $\pm 2^\circ$  shifts the minimum of Rp to longer or shorter wavelengths which can improve the polarization ratio significantly.

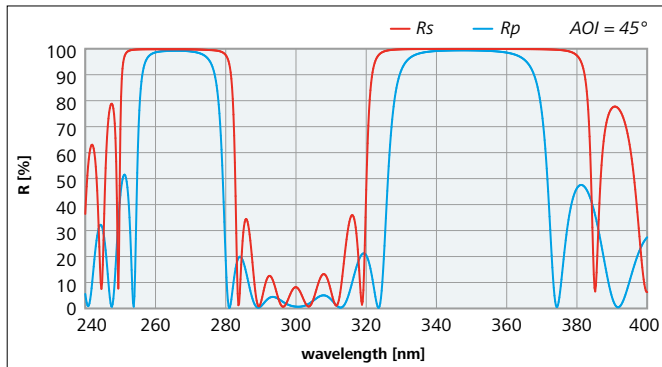
Table 1: Technical Data of Mirrors and Separators

Type of Coating	IAD	IBS
Mirror for AOI = 0°	R > 99.9 %	R > 99.9 %
Turning Mirror	Rs > 99.9 %, Rp > 99 %	Rs > 99.95 %, Rp > 99.8 %
Separator AOI = 45°	Rs (355 nm) > 99.9 %	Rs (355 nm) > 99.9 %
	Rp (355 nm) > 99 %	Rp (355 nm) > 99.7 %
	Rs (532 nm) < 5 %	Rs (532 nm) < 2 %
	Rp (532 nm) < 2 %	Rp (532 nm) < 1 %
	Rs (1064 nm) < 10 %	Rs (1064 nm) < 2 %
	Rp (1064 nm) < 2 %	Rp (1064 nm) < 1 %

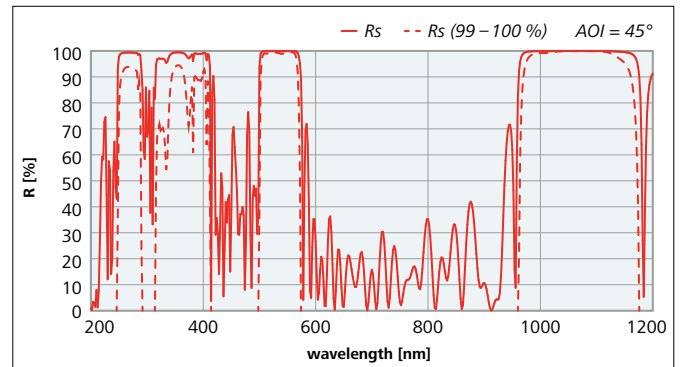
# Higher Harmonics of High Power Lasers on the Basis of Yb- and Nd-doped Materials (213 nm, 266 nm)

The harmonics of Nd:YAG and Nd:YVO<sub>4</sub> lasers are widely used for material processing as well as for measurement applications. LAYERTEC offers a variety of optics utilizing the fourth (266 nm) and fifth (213 nm) harmonic. All designs are calculated according to customer specifications.

## Multiple Wavelength Mirrors

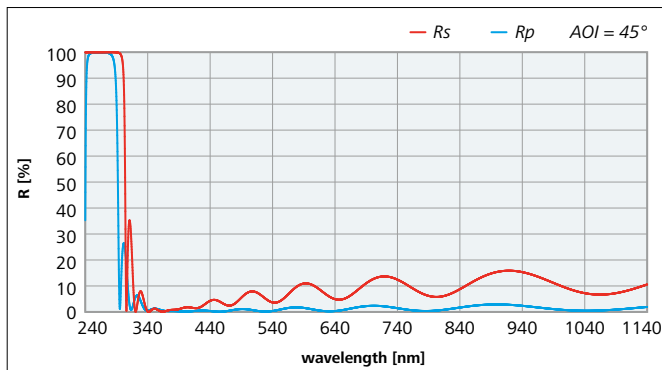


**Figure 1:** Reflectance spectra of a dual wavelength turning mirror for 266 nm and 355 nm



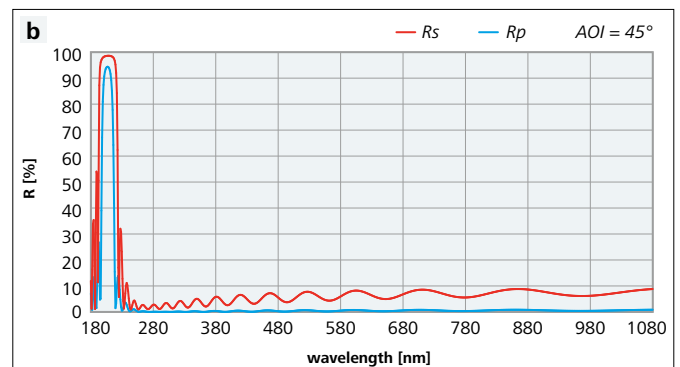
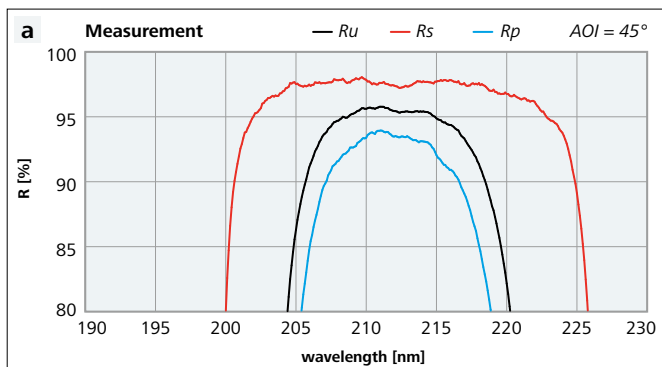
**Figure 2:** Reflectance spectra of a four wavelength turning mirror:  
 HRs (45°, 266 nm + 355 nm) > 99 %  
 + HRs (45°, 532 nm + 1064 nm) > 99.9 %

## Separators for the Fourth Harmonic



**Figure 3:** Reflectance spectra of a separator reflecting the fourth harmonic and transmitting the lower harmonics and the fundamental wave

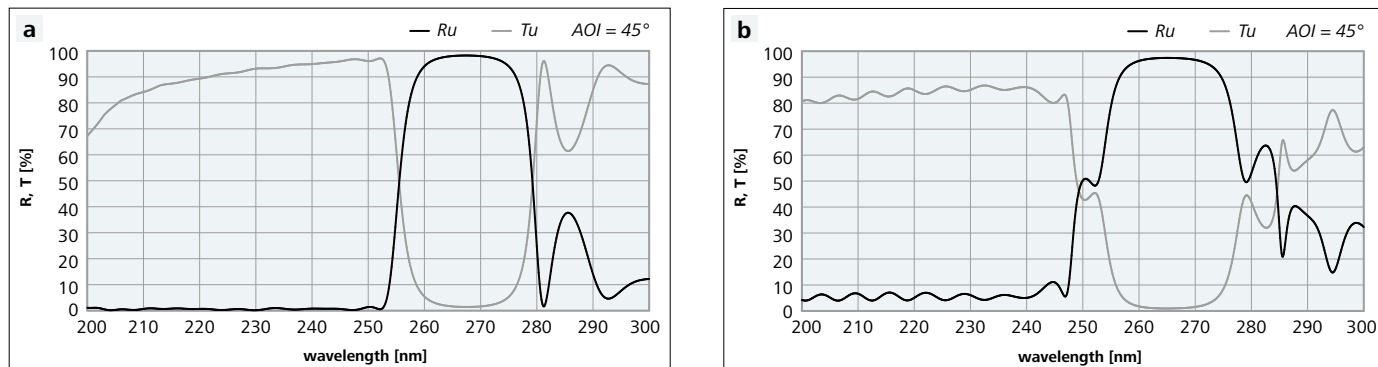
## Separators for the Fifth Harmonic



**Figure 4:** Reflectance spectra of fluoride coatings on CaF<sub>2</sub>:  
**a)** Turning mirror for the fifth harmonic (measured spectra)  
**b)** Separator reflecting the fifth harmonic and transmitting the lower harmonics and the fundamental

Special Separators

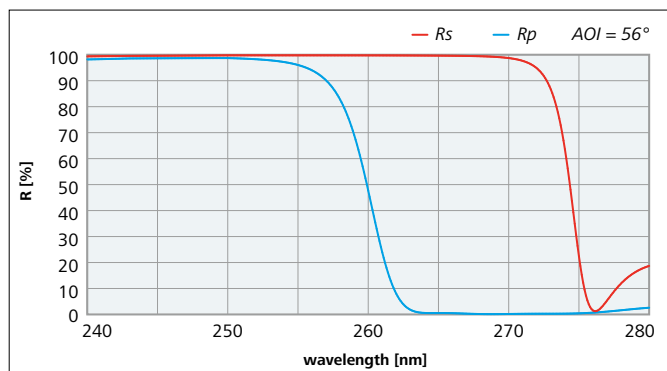
The fifth harmonic at 213 nm is a critical wavelength for oxide coatings because the absorption edge of aluminum oxide begins in this wavelength range. However, aluminum oxide is the only high index oxide material which can be used for 213 nm. Compared to fluorides, oxide coatings are hard and show low scattering losses. Fluorides in contrast exhibit higher LIDT values and extended lifetime for medium and high power applications.



**Figure 5:** Reflectance spectra of separators for the fourth and fifth harmonics:  
 HRu (45°, 266 nm) > 98 % + Ru (45°, 213 nm) < 10 % for unpolarized light  
**a)** Oxide coating optimized for low scattering losses  
**b)** Fluoride coating for high laser-induced damage thresholds

Thin Film Polarizers

Sputtering techniques enable LAYERTEC to offer thin film polarizers also for the fourth harmonic of the Nd:YAG laser.



**Figure 6:** Reflectance spectrum of a thin film polarizer for 266 nm:  
 HRs (56°, 266 nm) > 98 % + Rp (56°, 266 nm) < 5 %,   
 Tp (56°, 266 nm) ≈ 95 %

**Table 1:** Common specifications of separators for the harmonics in the UV

Separator Type	Technology	Reflectance at Center Wavelength		Reflectance at the Corresponding Longer Nd:YAG Wavelengths							
		Rs	Rp	266 nm		355 nm		532 nm		1064 nm	
				Rs	Rp	Rs	Rp	Rs	Rp	Rs	Rp
3 <sup>rd</sup> harmonic, 355 nm	IAD	> 99.9 %	> 99.5 %					< 5 %	< 2 %	< 10 %	< 2 %
	Sputtered	> 99.9 %	> 99.8 %					< 2 %	< 1 %	< 2 %	< 1 %
4 <sup>th</sup> harmonic, 266 nm	IAD	> 99.7 %	> 99.4 %			< 5 %	< 2 %	< 10 %	< 2 %	< 10 %	< 2 %
	Sputtered	> 99.8 %	> 99.5 %			< 5 %	< 1 %	< 2 %	< 1 %	< 2 %	< 1 %
5 <sup>th</sup> harmonic, 213 nm*	Evaporated	> 97 %	> 93 %	< 5 %	< 2 %	< 10 %	< 2 %	< 10 %	< 2 %	< 10 %	< 2 %

\* Fluoride coating on CaF<sub>2</sub>

# Weak Nd:YAG or Nd:YVO<sub>4</sub> Laser Lines (915 nm, 946 nm, 1123 nm, 1340 nm)

Neodymium doped crystals exhibit laser transitions at different wavelengths. Table 1 and table 2 give an overview about the laser wavelengths of the most common Nd-doped materials Nd:YAG and Nd:YVO<sub>4</sub>.

**Table 1:** Laser lines and corresponding wavelengths of the second harmonic of Nd:YAG

Laser Lines	Second Harmonic
946 nm	473 nm
1064 nm	532 nm
1123 nm	561 nm
1319 nm	659 nm
1338 nm	669 nm
1415 nm	708 nm
1444 nm	722 nm

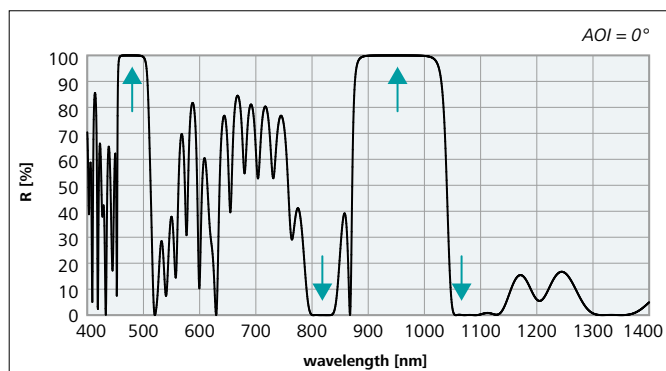
**Table 2:** Laser lines and corresponding wavelengths of the second harmonic of Nd:YVO<sub>4</sub>

Laser Lines	Second Harmonic
915 nm	457 nm
1064 nm	532 nm
1342 nm	671 nm

A variety of laser lines in the VIS and NIR can be obtained from these crystals. This process is utilized to build compact diode pumped solid state lasers with a variety of wavelengths which are used for measurement applications as well as for projection systems (RGB lasers).

The strongest laser transition in both materials is the 1064 nm line. Efficient laser radiation at other wavelengths is only possible by suppressing this line. LAYERTEC offers a variety of laser mirrors for this application.

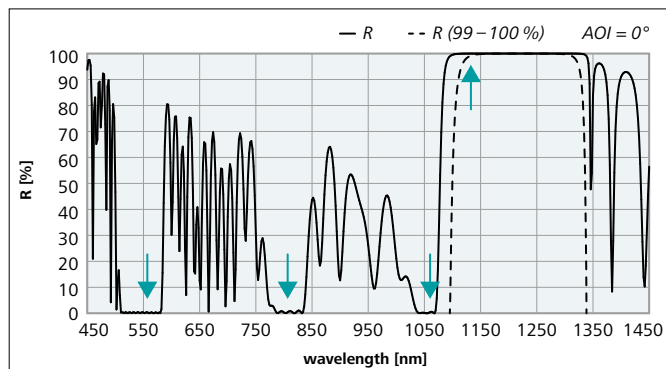
Compact laser designs also include the pump diode (808 nm) and a unit for the second harmonic generation. This is the reason why coatings for Nd:YAG or Nd:YVO<sub>4</sub> wavelengths apart from 1064 nm mostly show several spectral regions of high transmittance as well as high reflectance. All coatings are designed according to customer specifications, because the specifications depend on the laser design. All examples on these pages are for Nd:YAG wavelengths. Coatings for Nd:YVO<sub>4</sub> can be designed and produced as well.



**Figure 1:** Reflectance spectrum of a dual wavelength mirror for a weak laser line and its second harmonic with high transmittance for the pump wavelength and the strongest laser line:  
 $HR(0^\circ, 473 \text{ nm}) > 99.85\% + HR(0^\circ, 946 \text{ nm}) > 99.95\%$   
 $+ R(0^\circ, 808 \text{ nm}) < 2\% + R(0^\circ, 1064 \text{ nm}) < 5\%$

**Table 3:** Special features of the mirror from figure 1

Feature	Reflectance
Suppression of the strongest laser line	$R(0^\circ, 1064 \text{ nm}) < 5\%$
HR mirror for the weak laser line	$R(0^\circ, 946 \text{ nm}) > 99.95\%$
High transmittance for the pump wavelength	$R(0^\circ, 808 \text{ nm}) < 2\%$
HR mirror for the second harmonic of the weak laser line	$HR(0^\circ, 473 \text{ nm}) > 99.85\%$



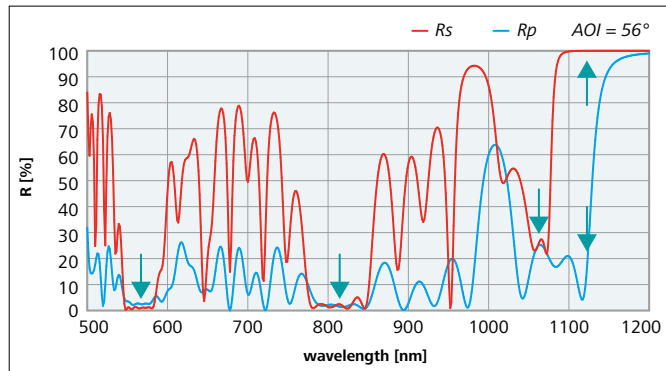
**Figure 2:** Reflectance spectrum of a dichroic mirror with high transmittance for the pump wavelength which also suppresses the 1064 nm line:  
 $HR(0^\circ, 1123 \text{ nm}) > 99.9\% + R(0^\circ, 561 \text{ nm}) < 2\%$   
 $+ R(0^\circ, 808 \text{ nm}) < 10\% + R(0^\circ, 1064 \text{ nm}) < 50\%$

**Table 4:** Special features of the mirror from figure 2

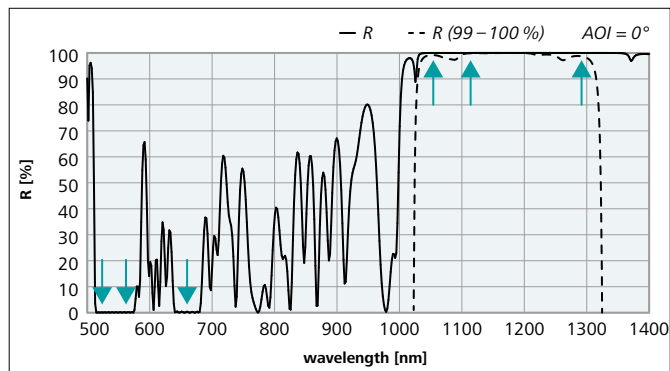
Feature	Reflectance
HR mirror for the weak laser line	$HR(0^\circ, 1123 \text{ nm}) > 99.9\%$
Suppression of the strongest laser line	$R(0^\circ, 1064 \text{ nm}) < 50\%$
High transmittance for the pump wavelength	$R(0^\circ, 808 \text{ nm}) < 10\%$
High transmittance for the second harmonic of the weak laser line	$R(0^\circ, 561 \text{ nm}) < 2\%$

## Selection of Optical Components for Common Laser Types

### Weak Nd:YAG or Nd:YVO4 Laser Lines (915 nm, 946 nm, 1123 nm, 1340 nm)



**Figure 3:** Reflectance spectra of a thin film polarizer with high transmittance for the pump wavelength and the second harmonic which also suppresses the 1064 nm line:  
 $HRs(56^\circ, 1123 \text{ nm}) > 99.9\% + Rp(56^\circ, 1123 \text{ nm}) < 50\%$   
 $+ Rs,p(56^\circ, 561 \text{ nm} + 808 \text{ nm}) < 10\%$   
 $+ Rs,p(56^\circ, 1064 \text{ nm}) < 50\%$



**Figure 4:** Reflectance spectrum of a dichroic mirror with high reflectance for the NIR wavelengths and high transmittance for the corresponding second harmonic wavelengths:  
 $HR(0^\circ, 1064 \text{ nm} + 1123 \text{ nm} + 1319 \text{ nm}) > 99.9\%$   
 $+ R(0^\circ, 532 - 561 \text{ nm} + 659 \text{ nm}) < 2\%$

**Table 5:** Special features of the mirror from figure 3

Feature	Reflectance
HR for s-polarized light of the weak laser line	$HRs(56^\circ, 1123 \text{ nm}) > 99.9\%$
Suppression of p-polarized light of the weak laser line	$Rp(56^\circ, 1123 \text{ nm}) < 50\%$
Suppression of the strongest laser line	$Rs,p(56^\circ, 1064 \text{ nm}) < 50\%$
High transmittance for the pump wavelength	$Rs,p(56^\circ, 808 \text{ nm}) < 10\%$
High transmittance for the second harmonic of the weak laser line	$Rs,p(56^\circ, 561 \text{ nm}) < 10\%$

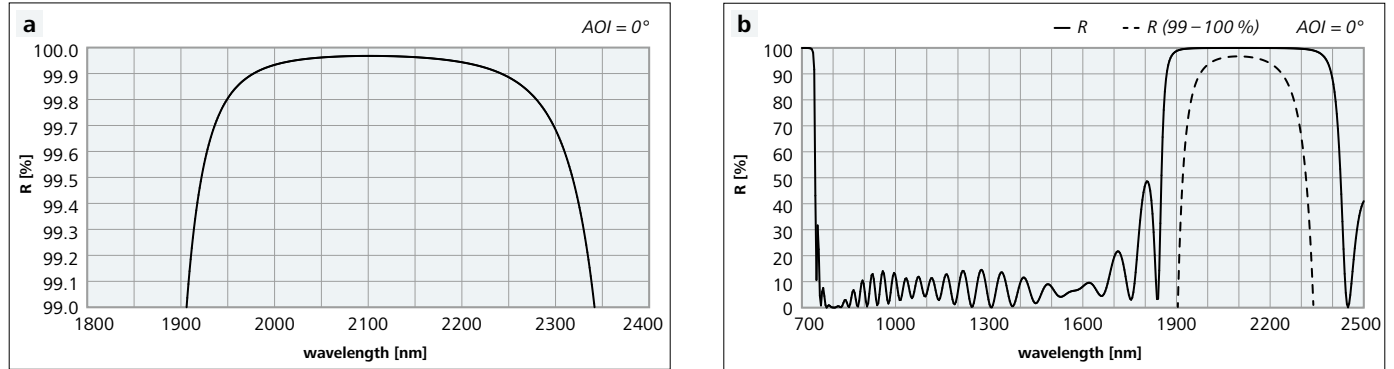
**Table 6:** Special features of the mirror from figure 4

Feature	Reflectance
Broadband HR mirror for several laser lines	$HR(0^\circ, 1064 \text{ nm} + 1123 \text{ nm} + 1319 \text{ nm}) > 99.9\%$
High transmittance for the second harmonics of these laser lines	$R(0^\circ, 532 - 561 \text{ nm} + 659 \text{ nm}) < 2\%$

## Ho:YAG and Tm:YAG Lasers (2010 nm, 2100 nm)

Ho:YAG and Tm:YAG lasers emitting at wavelengths of 2010 nm and 2100 nm are widely used for medical applications. LAYERTEC offers optical coatings for this wavelength range with high laser-induced damage thresholds and long lifetimes.

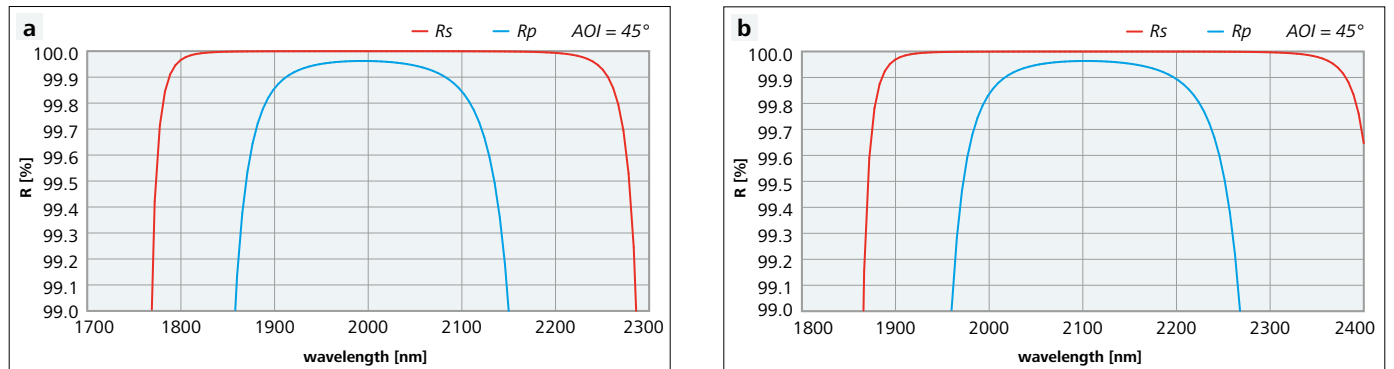
### Cavity Mirrors



**Figure 1:** Reflectance spectra of cavity mirrors:  
**a)** HR cavity mirror  
**b)** Pump mirror with high transmittance around 808 nm

- HR cavity and pump mirrors with  $R > 99.9\%$
- High laser-induced damage thresholds

### Turning Mirrors

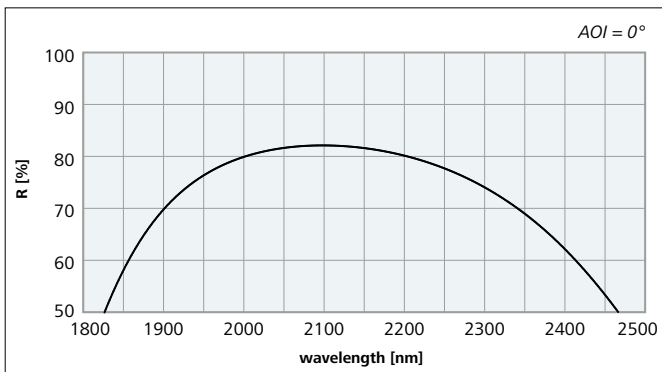


**Figure 2:** Reflectance spectra of turning mirrors for:  
**a)** 2010 nm  
**b)** 2100 nm

The coating materials are chosen to guarantee high laser-induced damage thresholds. To achieve the maximum reflectance for p-polarization, mirrors should be specified for either 2010 nm or 2100 nm.

- Turning mirrors with  $R > 99.9\%$  for s-polarized light and  $R > 99.8\%$  for p-polarized light at  $\text{AOI} = 45^\circ$
- High laser-induced damage thresholds

## Output Couplers

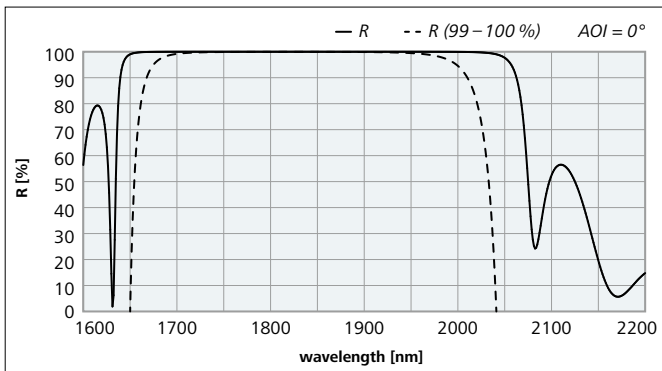


**Figure 3:** Reflectance spectrum of an output coupler with  $R = 82 \% \pm 1 \%$  at 2100 nm

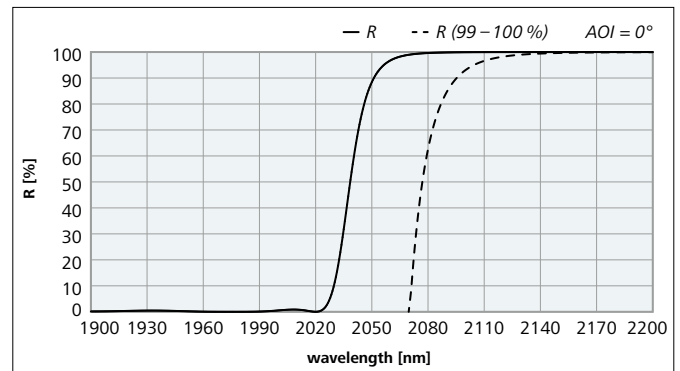
Output couplers with precisely adjusted degrees of reflectance:

- $R > 95 \% \pm 0.5 \%$
- $R = 80 \dots 95 \% \pm 1 \%$
- $R = 10 \dots 80 \% \pm 2 \%$

## Edge Filters

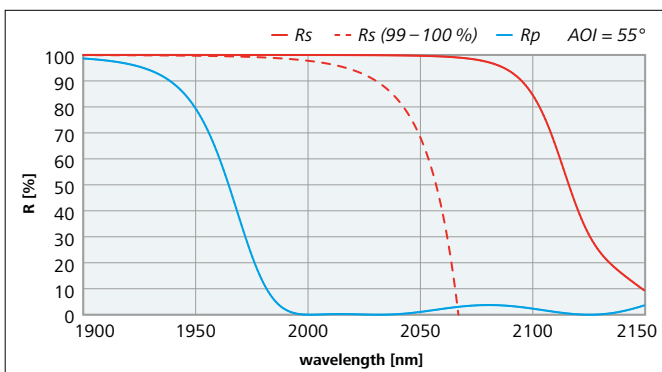


**Figure 4:** Reflectance spectra of a cavity mirror for 2010 nm suppressing the 2100 nm line



**Figure 5:** Reflectance spectra of a steep edge filter for the separation of the 2010 nm and 2100 nm lines

## Thin Film Polarizers



**Figure 6:** Reflectance spectra of a thin film polarizer for 2010 nm with  $R_s > 99.8 \%$ ,  $R_p < 2 \%$ ,  $AOI = 55^\circ$

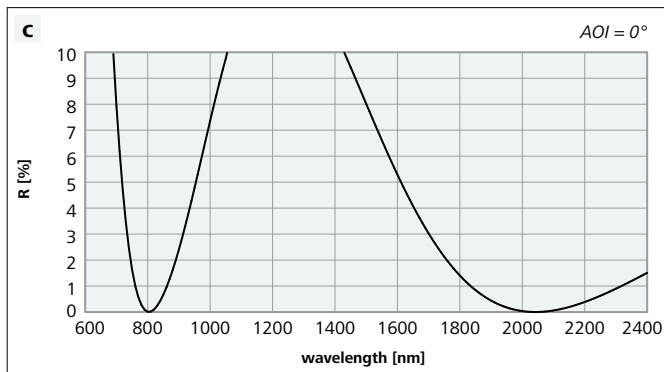
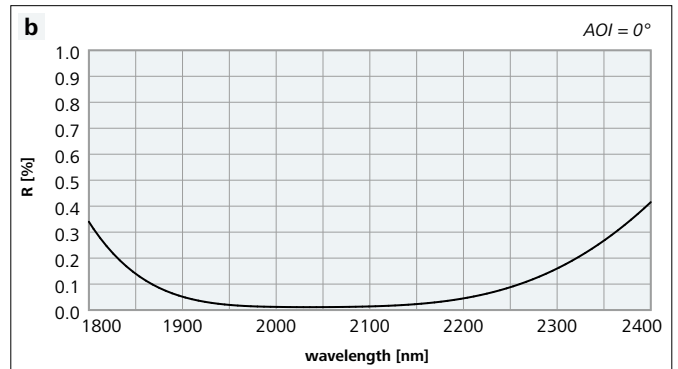
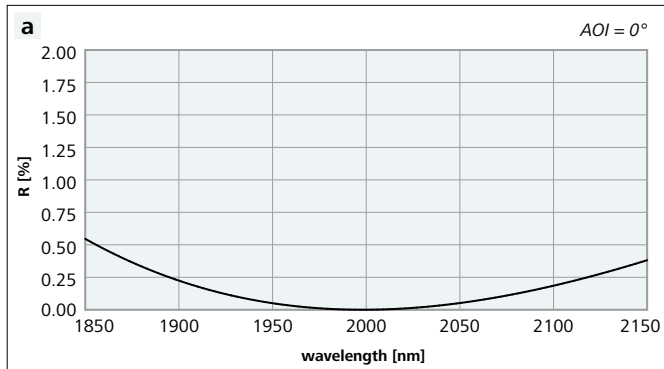
- Separation of the s- and p-polarized component of the light (s-polarized light is reflected, p-polarized light is transmitted)
- Thin film polarizers designed at Brewster's angle ( $\approx 55^\circ$ ) exhibit a higher  $T_p/T_s$  ratio and a considerably broader bandwidth than those at  $AOI = 45^\circ$



## Windows and Lenses

Lens materials according to customer specifications:

- Fused Silica with low OH-content, like Suprasil® 3001/3002/300
- Infrasil®, sapphire and undoped YAG can be used
- Special AR coatings for high index materials such as GGG on request

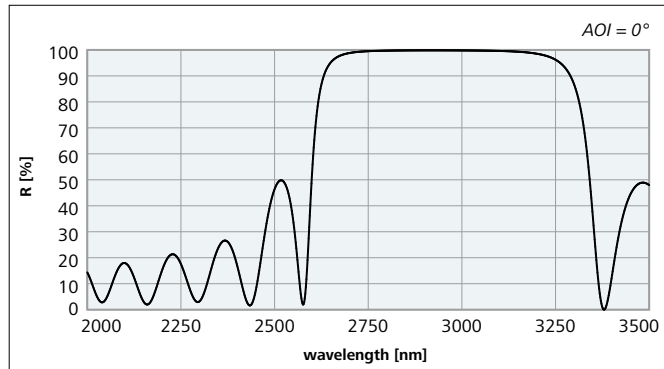


**Figure 7:** Reflectance spectra of typical antireflection coatings:  
**a)** Single wavelength AR coating for 2010 nm  
**b)** Broadband AR coating 2010 – 2100 nm  
**c)** Dual wavelength AR coating for the pump and laser wavelength (808 nm + 2010 nm)

## Er:YAG Lasers and the 3 $\mu\text{m}$ Region

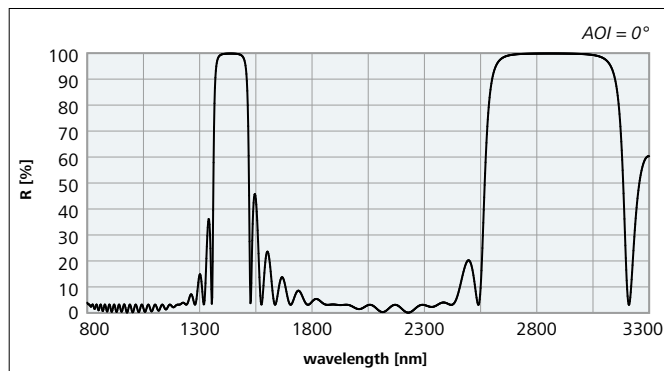
Er:YAG lasers are widely used in medical applications, especially in dermatology, due to the high absorption coefficient of water for 2940 nm radiation. This makes surgical applications easier but is also a challenge for the optical coatings which must be completely free of water. Coatings produced by magnetron sputtering have proved to be ideal for this kind of application.

### Cavity Mirrors



**Figure 1:** Reflectance spectrum of an HR cavity mirror  
HR ( $0^\circ$ , 2940 nm) > 99.8 %

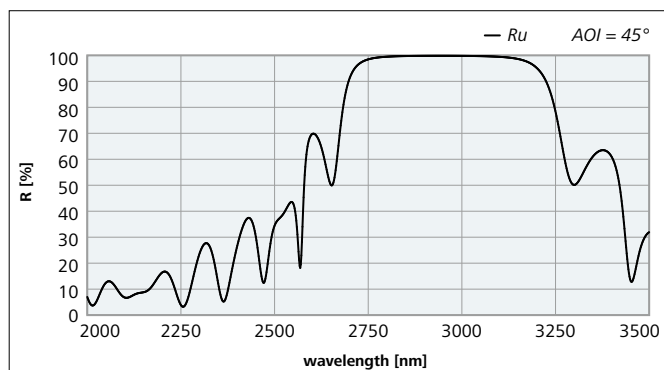
### Pump Mirrors



**Figure 2:** Reflectance spectrum of a HR cavity mirror with an HT region  
between 800 nm and 1100 nm

- Reflectance of cavity mirrors and pump mirrors:  $R > 99.9\%$  at  $\text{AOI} = 0^\circ$
- Pump mirrors with high transmittance between 800 nm and 1100 nm for pumping with a Nd:YAG laser or a diode laser

### Turning Mirrors



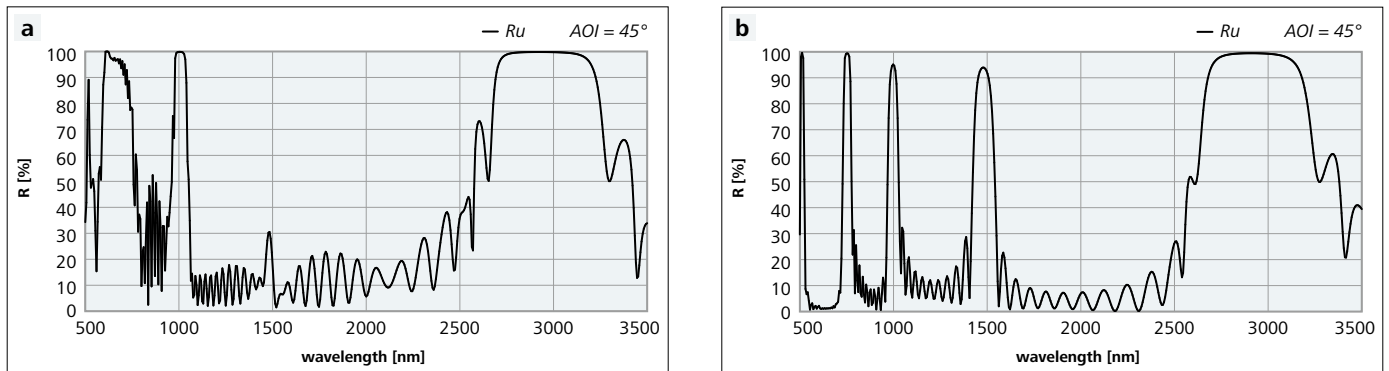
**Figure 3:** Reflectance spectrum of a turning mirror for unpolarized light

- Reflectance of turning mirrors:  $R > 99.8\%$  at  $\text{AOI} = 45^\circ$  for unpolarized light

#### LIDT Info

400 J/cm<sup>2</sup>, 2940 nm, 400  $\mu\text{s}$

## Beam Combiners and Alignment Laser Mirrors



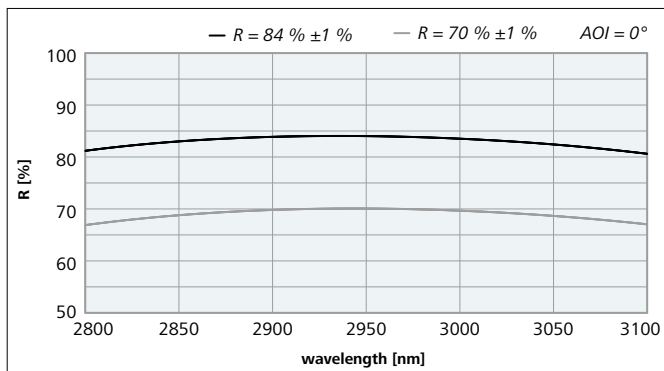
**Figure 4:** Reflectance spectra of turning mirrors

**a)** Dual wavelength turning mirror for 2940 nm and an alignment laser between 630 nm and 655 nm

**b)** Separator/combiner for 2940 nm and an alignment laser between 630 nm and 655 nm

- Designs for beam splitters and alignment laser mirrors are calculated according to customer specifications

## Output Couplers and Lenses



**Figure 5:** Reflectance spectra of output couplers with  $R = 70\% \pm 1\%$  and  $R = 84\% \pm 1\%$

- Output couplers with precisely adjusted degrees of reflectance (tolerances of  $\pm 1\%$  at reflectance values between 70 % and 90 %)
- AR coatings with residual reflectance of  $R < 0.2\%$  on the rear side of output couplers as well as on lenses and windows
- Infrasil<sup>®</sup>, sapphire and undoped YAG can be used (for substrate materials see page 138 ff.)

# Ultrafast Laser Optics

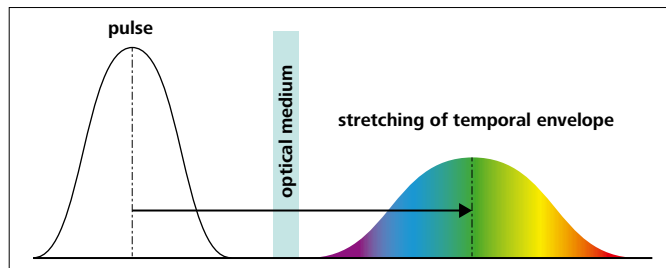
## Chapter Index

<b>Introduction to Ultrafast Laser Optics</b> .....	<b>35</b>	<b>High Power Ultrafast Laser Optics (550 – 1100 nm)</b> .....	<b>54</b>
GDD and TOD .....	36	Overview about Laser-Induced Damage Thresholds of	
<b>Standard Ultrafast Laser Optics</b>		Ultrafast Laser Optics .....	55
<b>(120 – 150 nm Bandwidth)</b> .....	<b>37</b>	Metallic High Power Mirrors .....	56
Cavity Mirrors AOI = 0° .....	37	GDD of High Power Ultrafast Laser Mirrors.....	56
Pump Mirrors AOI = 0° .....	37	<b>Components for the Second Harmonic of the</b>	
Turning Mirrors AOI = 45° .....	38	<b>Ti:Sapphire Laser (300 – 600 nm)</b> .....	<b>57</b>
Output Couplers AOI = 0° .....	38	Dual Wavelength Mirrors for AOI = 0° .....	57
Beam Splitters for p-polarized light at AOI = 45° .....	38	Dual Wavelength Turning Mirrors for AOI = 45° .....	58
Beam Splitters for s-polarized light at AOI = 45° .....	39	Separators for the Second Harmonic from the	
Negative Dispersion Mirrors AOI = 0° .....	39	Fundamental for AOI = 45° .....	58
High Dispersion Mirrors AOI = 0° .....	40	Negative Dispersion Mirror Pair for the 400 nm	
High Dispersion Mirror Pairs AOI = 0° .....	40	Spectral Range at AOI = 0° .....	59
Thin Film Polarizers for AOI = 55° .....	41	<b>Components for the Third Harmonic of the</b>	
Thin Film Polarizers for AOI = 65° .....	41	<b>Ti:Sapphire Laser (250 – 400 nm)</b> .....	<b>60</b>
Thin Film Polarizers for AOI = 80° .....	42	Dual Wavelength Turning Mirrors for AOI = 45° .....	60
Non-polarizing Beam Splitters for AOI = 45° .....	42	Triple Wavelength Turning Mirrors for AOI = 45° .....	60
Antireflection Coatings .....	43	Separators for the Third Harmonic from the Second	
<b>Broadband Ultrafast Laser Optics</b>		Harmonic and the Fundamental Wave for AOI = 45° .....	60
<b>(200 – 300 nm Bandwidth)</b> .....	<b>44</b>	Negative Dispersion Mirror Pair for AOI = 0° .....	61
Mirror Pairs for AOI = 0° .....	44	<b>Components for the Higher Harmonics of the</b>	
Turning Mirrors for s-polarized Light at AOI = 45° .....	44	<b>Ti:Sapphire Laser (140 – 250 nm)</b> .....	<b>62</b>
Turning Mirrors for p-polarized Light at AOI = 45° .....	45	Turning Mirrors and Separators for the Fourth Harmonic	
Output Couplers for AOI = 0° .....	45	at AOI = 45° .....	62
Beam Splitters for p-polarized Light at AOI = 45° .....	45	Components for the Fifth Harmonic at AOI = 45° .....	62
Beam Splitters for s-polarized Light at AOI = 45° .....	46	Components for the Sixth Harmonic at AOI = 45° .....	63
Negative Dispersion Pump Mirror Pairs for AOI = 0° .....	46	Bandwidth of the Reflectance and Low-GDD Range	
Thin Film Polarizers for AOI = 70° .....	47	of Standard Components .....	63
High Negative Dispersion Mirror Pairs for AOI = 0° .....	47	<b>Gires-Tournois-Interferometer (GTI) Mirrors</b>	
Mirror Pairs with Optimized Third Order Dispersion		<b>(600 – 1600 nm)</b> .....	<b>64</b>
for AOI = 0° .....	48	GTI-Mirrors for Yb:YAG and Yb:KGW-Lasers .....	64
<b>Octave Spanning Ultrafast Laser Optics</b>		Optical Losses of GTI-Mirrors.....	65
<b>(400 – 500 nm Bandwidth)</b> .....	<b>49</b>	Coating Homogeneity and Reproducibility of GTI-Mirrors.....	66
Negative Dispersion Laser Mirror Pairs for AOI = 0° .....	49	<b>Optics for Ultrafast Lasers</b>	
Negative Dispersion Pump Mirror Pairs for AOI = 0° .....	49	<b>in the Wavelength Range of 1000 – 1600 nm</b> .....	<b>67</b>
Negative Dispersion Turning Mirror Pairs for		Negative Dispersion Laser and Pump Mirrors for AOI = 0° .....	67
p-polarized Light for AOI = 0° .....	50	GTI-Mirrors for AOI = 0° .....	68
Output Couplers for AOI = 0° .....	50	Broadband Negative Dispersion Mirror Pairs for AOI = 0° .....	68
Beam Splitters for p-polarized Light at AOI = 45° .....	51	Broadband Negative Dispersion Turning Mirrors	
Beam Splitters for s-polarized Light at AOI = 45° .....	51	for AOI = 45° .....	69
<b>Silver Mirrors for Ultrafast Lasers (550 – 1100 nm)</b> .....	<b>52</b>		
Silver Mirrors Optimized for Laser Applications .....	52		
Silver Mirrors with Enhanced Reflectance .....	53		

# Introduction to Ultrafast Laser Optics

Ultrafast lasers are used in numerous applications such as time resolved spectroscopy, precision material processing and non-linear optics. Driven by these applications, recent developments in this field are directed to lasers generating higher output power and shorter pulses. Currently, most short pulse physics is done with Ti:Sapphire lasers. Solid-state lasers based on other transition metal or rare earth metal doped crystals (Nd:YAG, Nd:YVO<sub>4</sub>, Yb:KGW) are also used for the generation of ultrashort pulses. The reproducible generation of sub-100 fs-pulses is closely connected to the development of broadband low loss dispersive delay lines consisting of prism or grating pairs or of dispersive multilayer reflectors.

The spectral bandwidth of a pulse is related to the pulse duration by a well-known theorem of Fourier analysis. For instance, the bandwidth (FWHM) of a 100 fs Gaussian pulse at 800 nm is 11 nm. For shorter pulses, the wavelength spectrum becomes significantly broader. A 10 fs pulse has a bandwidth of 107 nm.



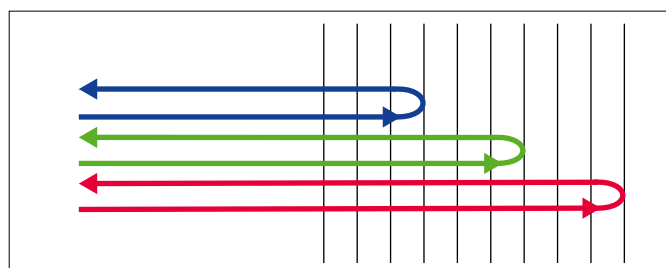
**Figure 1:** Broadening of a pulse by propagation through an optical medium (schematic drawing)

If such a broad pulse passes through an optical medium, the spectral components of this pulse propagate with different speeds. Dispersive media, like glass, impose a so-called “positive chirp” on the pulse, meaning that the short wavelength (“blue”) components are delayed with respect to the long wavelength (“red”) components (see schematic drawing in figure 1).

A similar broadening can be observed if a pulse is reflected by a dielectric mirror and the bandwidth of the pulse is larger or equal to the width of the reflection band of the mirror. Consequently, broadband mirrors consisting of a double stack system cause pulse broadening because the path lengths of the spectral components of the pulse are extremely different in these coatings.

In the sub-100 fs-regime it is essential to control the phase properties of each optical element over the extremely wide bandwidth of the fs-laser. This holds not only for the stretcher and compressor units, but also for the cavity mirrors, output couplers and the beam propagation system. In addition to the power spectrum, i.e. reflectance or transmittance, the phase relationship among the Fourier components of the pulse must be preserved in order to avoid broadening or distortion of the pulse.

Mathematical analysis of the phase shift, which is applied to a pulse passing through a medium or being reflected by a mirror (see part GDD and TOD), shows that the main physical properties which describe this phenomenon are the group delay dispersion (GDD) and the third order dispersion (TOD). These properties are defined as the second and third derivative of the phase with respect to the frequency.



**Figure 2:** Optical path lengths of blue, green and red light in a negative dispersion mirror (schematic drawing)

Especially designed dielectric mirrors offer the possibility to impose a “negative chirp” on a pulse. Thus, the positive chirp which results from crystals, windows, etc. can be compensated. The schematic drawing in figure 2 explains this effect in terms of different optical path lengths of blue, green and red light in a negative dispersion mirror.

LAYERTEC offers ultrafast laser optics with different bandwidths. This catalog shows optics for the wavelength range of the Ti:Sapphire laser in three chapters, each representing a characteristic bandwidth of the optics: standard components with a bandwidth of about 120 nm, broadband components (bandwidth about 300 nm) and octave spanning components.

Moreover, silver mirrors for fs applications are presented which offer the broadest low-GDD bandwidth available.

Please note that the GDD spectrum of a dielectric negative dispersion mirror is not a flat graph. All types of negative dispersion mirrors exhibit oscillations in the GDD spectrum. These oscillations are small for standard bandwidths. However, broadband and ultra-broadband negative dispersion mirrors exhibit strong GDD oscillations. Considerable reduction of these oscillations can be achieved by using mirror pairs consisting of mirrors with carefully shifted GDD oscillations. Figure 3 shows a schematic drawing of said mirror pair and the corresponding GDD spectra.

It is also possible to use negative dispersion mirrors with high values of negative GDD for pulse compression. These so-called Gires-Tournois-Interferometer (GTI) mirrors (see page 64 f.) are successfully used in Ti:Sapphire lasers, Yb:YAG and Yb:KGW oscillators and Er:Fiber lasers. Pulse compression in Yb:YAG and Yb:KGW oscillators provides pulses of some hundred femto-seconds pulse length. For each wavelength, components with different amounts of negative GDD are presented on the following pages. Besides these optics for the spectral range of the Ti:Sapphire fundamental and for the very promising Yb:YAG and Yb:KGW lasers, LAYERTEC also offers optics for the harmonics of this radiation down to the VUV wavelength range, optics for ultrafast lasers in the 1500 nm-range and especially designed optics for high power ultra-short pulse lasers. LAYERTEC has its own capabilities for design calculation and also for GDD-measurements in the wavelength range from 250 to 1700 nm.

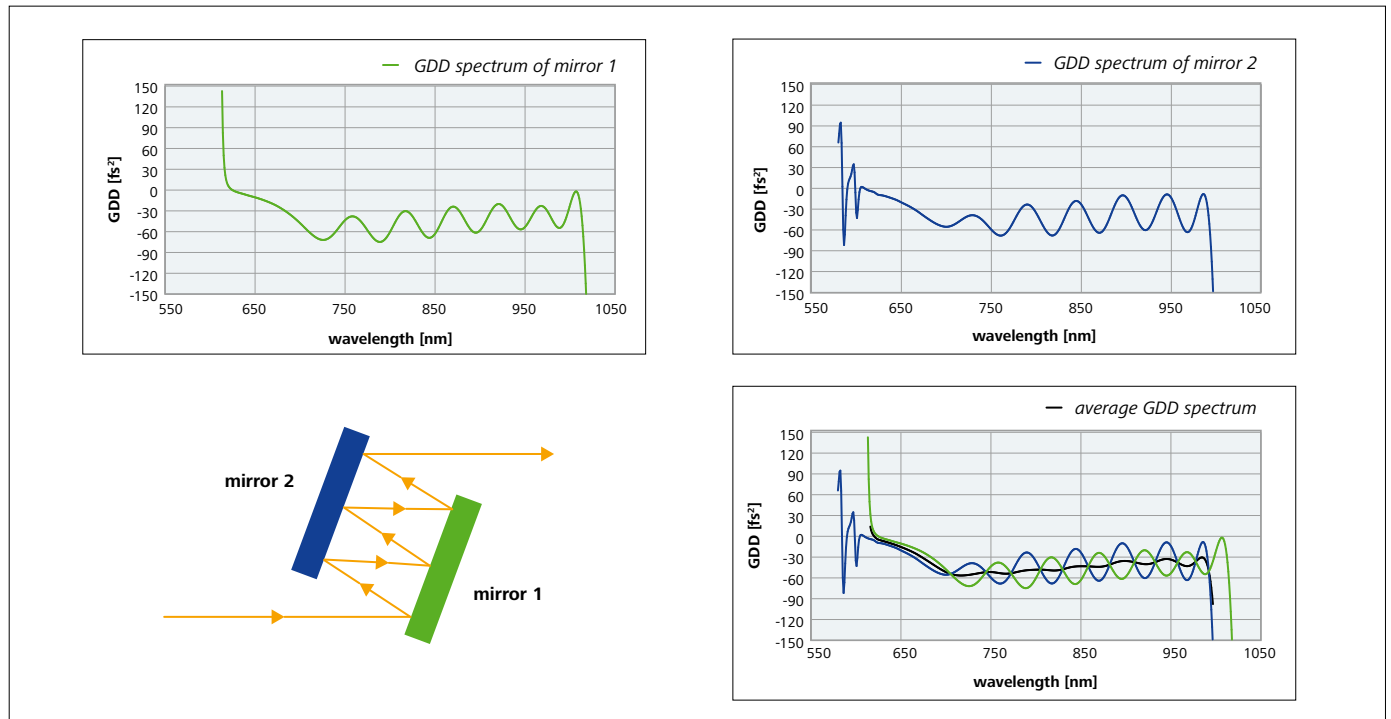


Figure 3: Schematic drawing of a negative dispersion mirror pair

## GDD and TOD

If a pulse is reflected by a dielectric mirror, i.e. a stack of alternating high and low refractive index layers, there will be a phase shift between the original and the reflected pulse resulting from the time which it takes the different Fourier components of the pulse to pass through the layer system of the mirror. In general, the phase shift  $\Phi(\omega)$  near the center frequency  $\omega_0$  may be expanded in a Taylor series for frequencies near  $\omega_0$ :

$$\Phi(\omega) = \Phi(\omega_0) + \Phi'(\omega_0)(\omega - \omega_0) + \Phi''(\omega_0)(\omega - \omega_0)^2/2 + \Phi'''(\omega_0)(\omega - \omega_0)^3/6 + \dots$$

The derivatives are, respectively, the Group Delay (GD)  $\Phi'(\omega_0)$ , the Group Delay Dispersion (GDD)  $\Phi''(\omega_0)$  and the Third Order Dispersion (TOD)  $\Phi'''(\omega_0)$ . More strictly speaking, this expansion is only useful in an exactly soluble model, for the propagation of a transform limited Gaussian pulse and for pure phase dispersion. For extremely short pulses and combinations of amplitude and phase dispersion numerical calculations may be necessary. Nevertheless, this expansion clearly shows the physical meaning of the single terms:

Assuming the phase shift is linear in frequency (i.e.  $\text{GD} \neq 0$ ,  $\text{GDD} = 0$  and  $\text{TOD} = 0$  over the pulse bandwidth), the reflected pulse is delayed in time by the constant group delay and, of course, scaled by the amplitude of reflectance  $R$ . The pulse spectrum will remain undistorted.

If  $\text{GDD} \neq 0$ , two important effects are observed:

- The reflected pulse is temporally broadened. This broadening effect depends only on the absolute value of the GDD. LAYERTEC offers “low GDD mirrors”, i.e. mirrors with  $|\text{GDD}| < 20 \text{ fs}^2$  over a given wavelength range, which guarantee the preservation of the pulse shape when the pulse is reflected by these mirrors.
- Moreover, the pulse becomes “chirped”, i.e. it changes its momentary frequency during pulse time. This effect depends on the sign of the GDD, so that the momentary frequency may become higher (up-chirp,  $\text{GDD} > 0$ ) or lower (down-chirp,  $\text{GDD} < 0$ ). This allows to compensate positive GDD effects of nonlinear optical elements by using negative GDD mirrors.

The TOD determines also pulse length and pulse shape (distortion of the pulse) and becomes a very important factor at pulse lengths of 20 fs and below.

## References

R. Holzwarth, M. Zimmermann, Th. Udem, T.W. Hänsch, P. Russbüldt, K. Gäbel, R. Poprawe, J.C. Knight, W.J. Wadsworth and P.St.J. Russell: “White-light frequency comb generation with a diode-pumped Cr:LiSAF laser”; *Optics Letters*, Vol. 26, No.17 (2001), p. 1376 – 1378

Y.-S. Lim, H.-S. Jeon, Y.-C. Noh, K.-J. Yee, D.S. Kim, J.-H. Lee, J.-S. Chang, J.-D. Park: “*Journal of the Korean Physical Society*”; Vol. 40, No.5 (2002), p. 837 – 843

G. Tempea, V. Yakovlev and F. Krausz: “Interference coatings for Ultrafast Optics”; in: N. Kaiser, H.K. Pulker (eds.), “Optical Interference Coatings”; Springer-Verlag Berlin Heidelberg 2003, p. 393 – 422 and the references therein

## Standard Ultrafast Laser Optics (120 – 150 nm Bandwidth)

- The coatings shown here are calculated for a bandwidth of 120 – 150 nm in the wavelength range between 600 nm and 1000 nm
- Very high reflectance of the mirrors ( $R > 99.99\%$ )
- Spectral tolerance 1 %
- In-house design calculation and GDD measurement capabilities
- Center wavelength, GDD and TOD according to customer specifications
- Measured GDD spectra available on request
- All kinds of mirrors (e.g. Cavity mirrors, pump mirrors and turning mirrors)

### LIDT Info

0.4 J/cm<sup>2</sup>, 800 nm, 42 fs, 1 kHz, Ø 80 µm\*

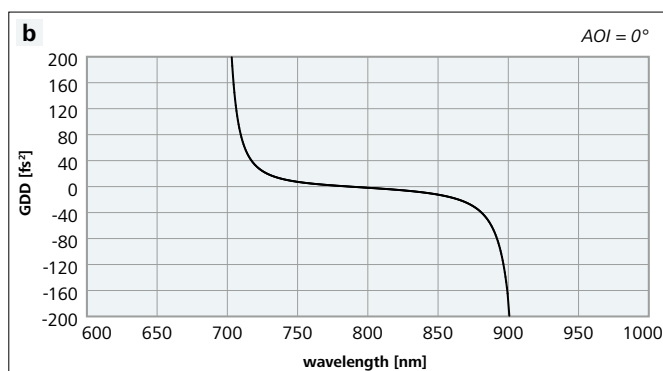
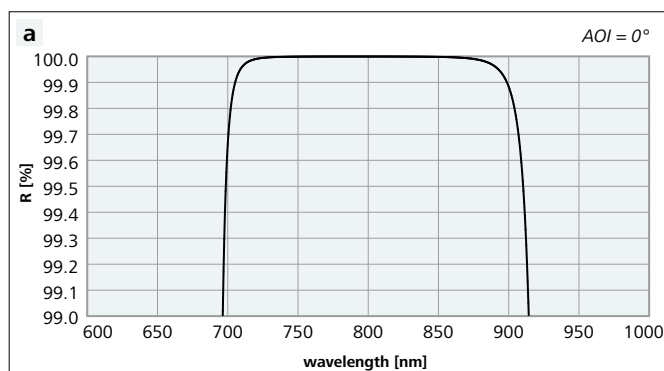
2 J/cm<sup>2</sup>, 800 nm, 70 fs, 10 Hz, Ø 700 µm\*\*

For high power mirrors see page 54 f.

\* Measurements were performed at Wigner Research Centre for Physics, Budapest

\*\* Measurements were performed at Helmholtz-Zentrum Dresden-Rossendorf

### Cavity Mirrors AOI = 0°

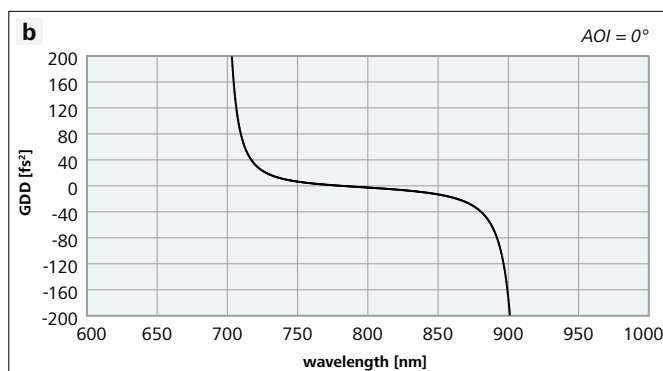
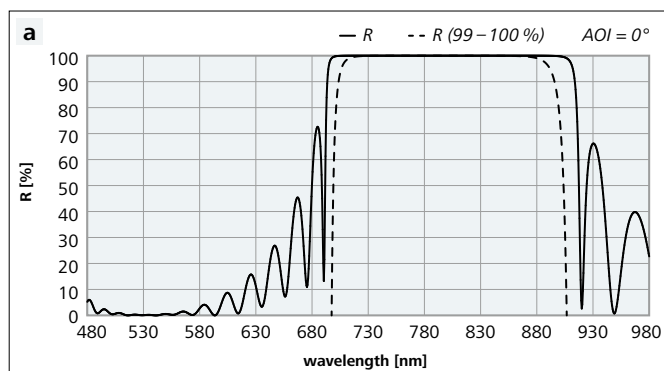


**Figure 1:** Reflectance and GDD spectra of a standard low dispersion ultrafast laser mirror

- a)** Reflectance vs. wavelength  
**b)** GDD vs. wavelength

All types of mirrors are also available with negative GDD (e.g. -40 fs<sup>2</sup>). For high dispersion mirrors see page 39.

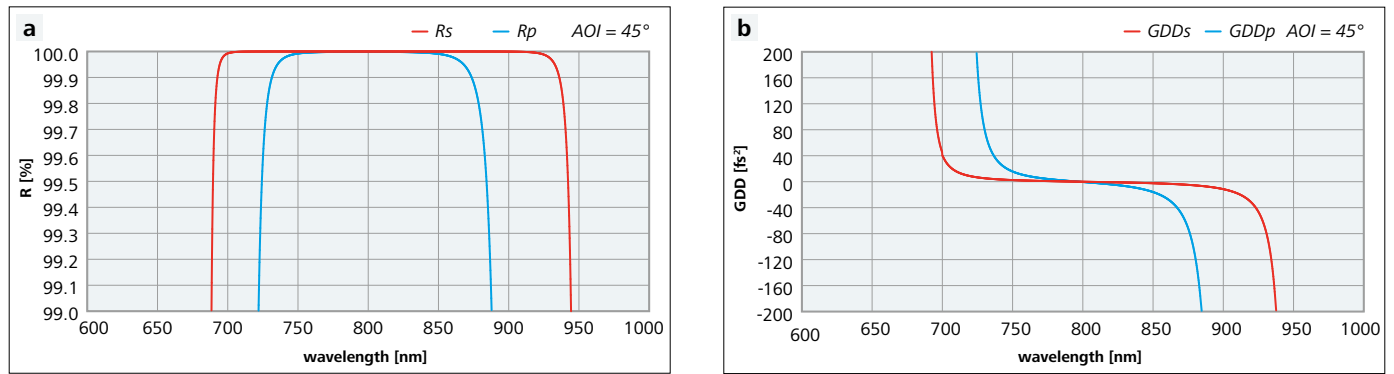
### Pump Mirrors AOI = 0°



**Figure 2:** Reflectance and GDD spectra of a standard low dispersion pump laser mirror

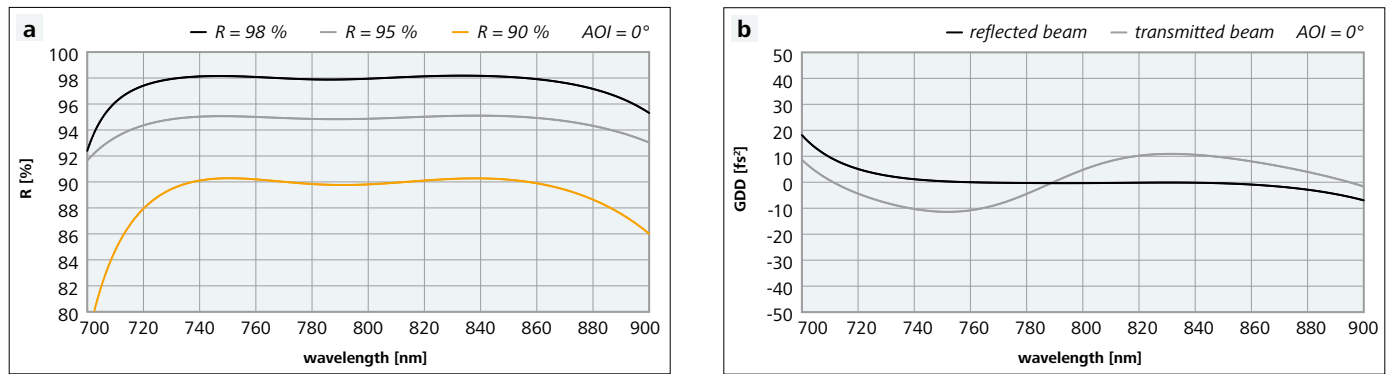
- a)** Reflectance vs. wavelength  
**b)** GDD vs. wavelength

Turning Mirrors AOI = 45°



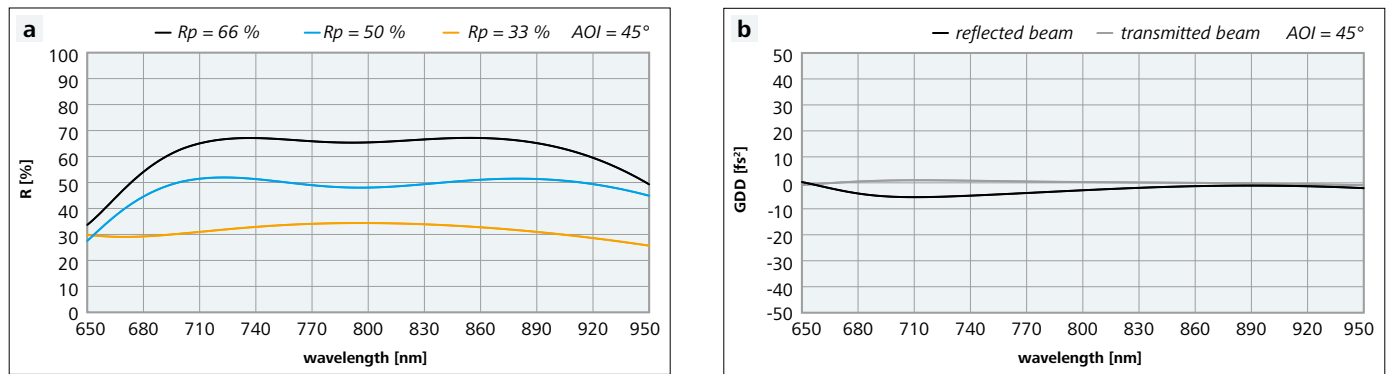
**Figure 3:** Reflectance and GDD spectra for a standard low dispersion turning mirror (bandwidth  $R_u$  (45°) > 99.9 % ≈ 160 nm)  
**a)** Reflectance vs. wavelength  
**b)** GDD vs. wavelength

Output Couplers AOI = 0°



**Figure 4:** Reflectance and GDD spectra of output couplers with a bandwidth of 120 nm  
**a)** Reflectance spectra of several standard output couplers  
**b)** GDD spectra of the output coupler with  $R = 98\%$ ; GDD spectra are similar for all levels of reflectance

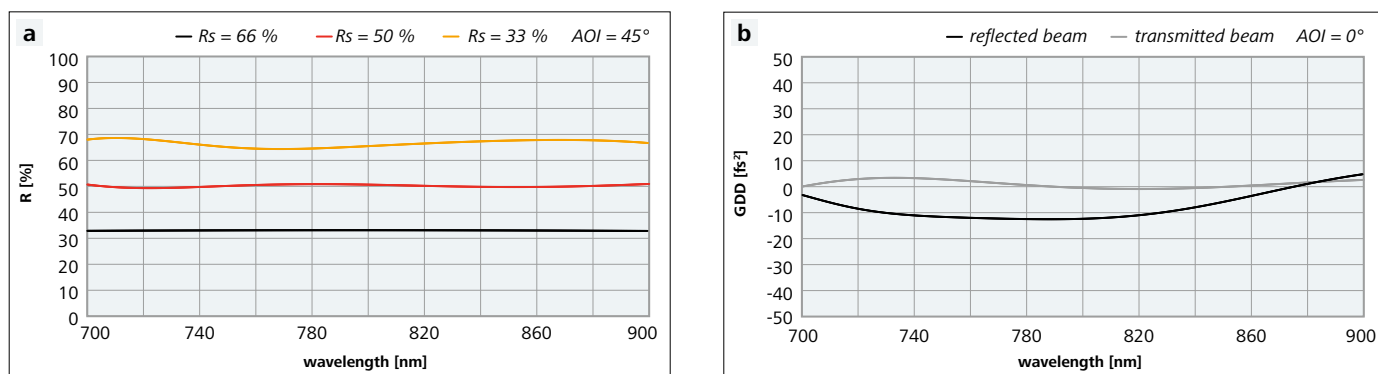
Beam Splitters for p-polarized light at AOI = 45°



**Figure 5:** Reflectance and GDD spectra of beam splitters for p-polarized light  
**a)** Reflectance spectra of several standard beam splitters and p-polarized light  
**b)** GDD spectra of the beam splitter with  $R = 50\%$ ; the GDD spectra are similar for all levels of reflectance



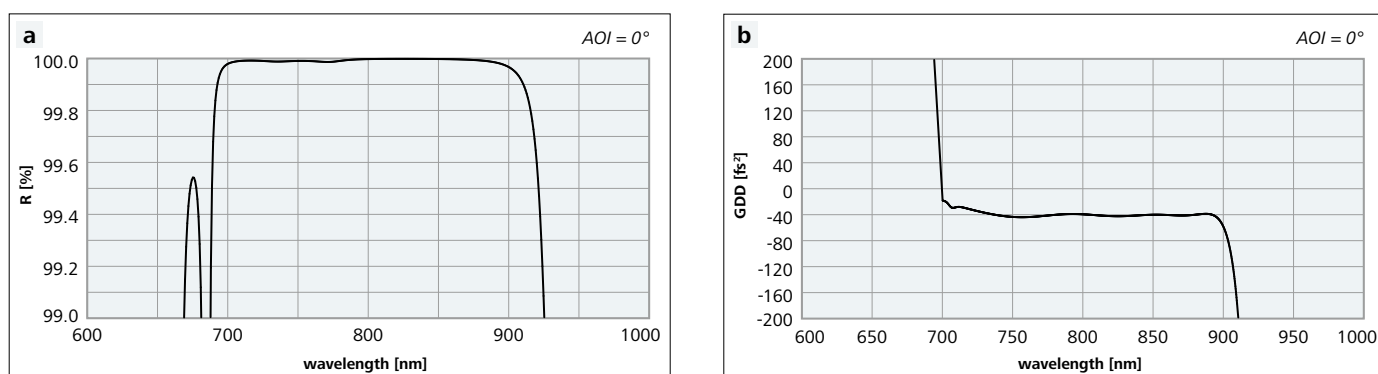
Beam Splitters for s-polarized light at AOI = 45°



**Figure 6:** Reflectance and GDD spectra of beam splitters for s-polarized light  
**a)** Reflectance spectra of several standard beam splitters and s-polarized light  
**b)** GDD spectra of the beam splitter with  $R = 50\%$ ; the GDD spectra are similar for all levels of reflectance

- Reflectance and transmittance of output couplers and beam splitters can be adjusted according to customer specifications
- Tolerances for output couplers:
  - $R = 10\% \dots 70\% \pm 2.5\%$
  - $R = 70\% \dots 90\% \pm 1.5\%$
  - $R = 90\% \dots 95\% \pm 0.75\%$
  - $R = 95\% \dots 98\% \pm 0.5\%$
  - $R > 98\% \pm 0.25\%$
  - $R > 99\% \pm 0.1\%$
- Standard AR coatings:
  - $AOI = 0^\circ$ :  $R < 0.2\%$
  - $AOI = 45^\circ$ :  $R_s$  or  $R_p < 0.2\%$
  - $AOI = 45^\circ$ :  $R_s \approx R_p \approx 0.5\%$
  - In case of p-polarization, uncoated rear side possible,  $R_p$  (Fused Silica,  $45^\circ$ )  $\approx 0.6\%$

Negative Dispersion Mirrors AOI = 0°

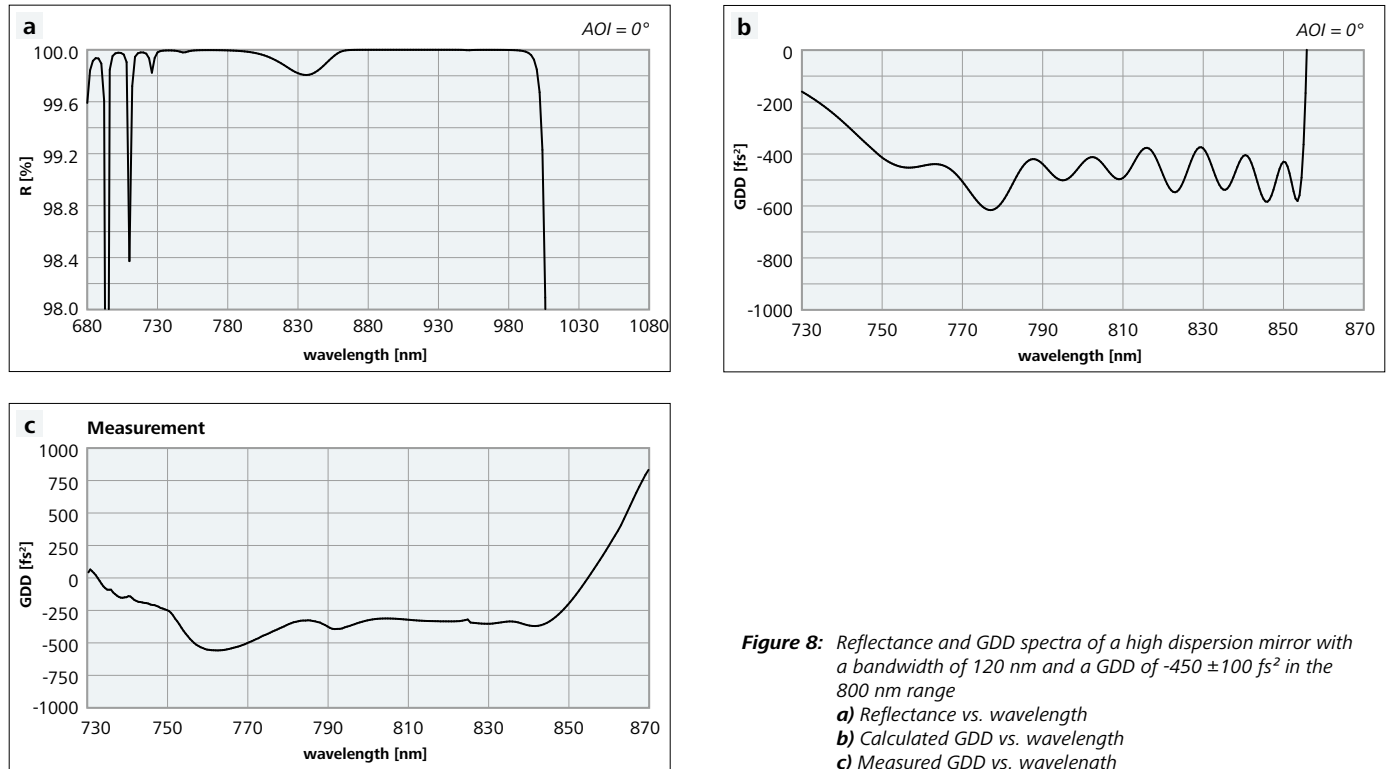


**Figure 7:** Reflectance spectra of aluminum mirrors  
**a)** Reflectance vs. wavelength  
**b)** GDD vs. wavelength

### High Dispersion Mirrors AOI = 0°

Recent advances in design calculation and process control enable LAYERTEC to offer high dispersion mirrors for pulse compression in advanced Ti:Sapphire lasers. These mirrors and mirror pairs show spectral bandwidths of 100 nm – 300 nm and negative GDD values of some hundred fs<sup>2</sup>. These mirrors can be used for pulse compression. Compared to prism compressors, high dispersion mirrors reduce the intra cavity losses resulting in higher output power of the laser.

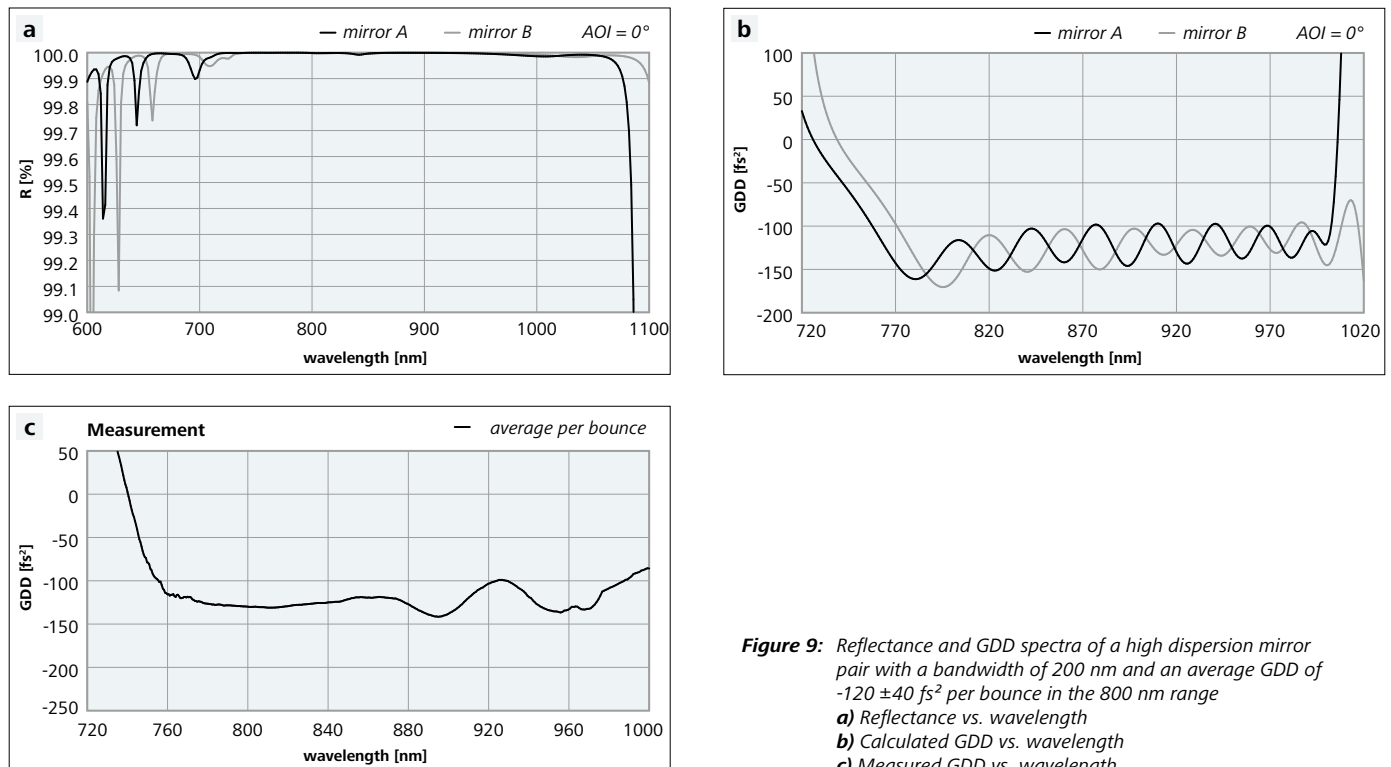
All high dispersion mirrors are designed according to customer specification. Please specify the amount GD which is to be compensated.



**Figure 8:** Reflectance and GDD spectra of a high dispersion mirror with a bandwidth of 120 nm and a GDD of  $-450 \pm 100$  fs<sup>2</sup> in the 800 nm range  
**a)** Reflectance vs. wavelength  
**b)** Calculated GDD vs. wavelength  
**c)** Measured GDD vs. wavelength

Matching measured and calculated GDD spectra prove the reliability of the coating process.

### High Dispersion Mirror Pairs AOI = 0°



**Figure 9:** Reflectance and GDD spectra of a high dispersion mirror pair with a bandwidth of 200 nm and an average GDD of  $-120 \pm 40$  fs<sup>2</sup> per bounce in the 800 nm range  
**a)** Reflectance vs. wavelength  
**b)** Calculated GDD vs. wavelength  
**c)** Measured GDD vs. wavelength

This very special type of optical coatings can be used to compensate the third order dispersion which results from laser crystals, substrates or dispersive elements like prisms or gratings. Positive as well as negative TOD can be achieved with this type of coatings. All coatings are optimized for nearly constant TOD which means TOD oscillations in the order of some hundreds of  $\text{fs}^3$ . Please note that without TOD optimization these oscillations are on the order of some thousands of  $\text{fs}^3$ .

Thin Film Polarizers for AOI = 55°

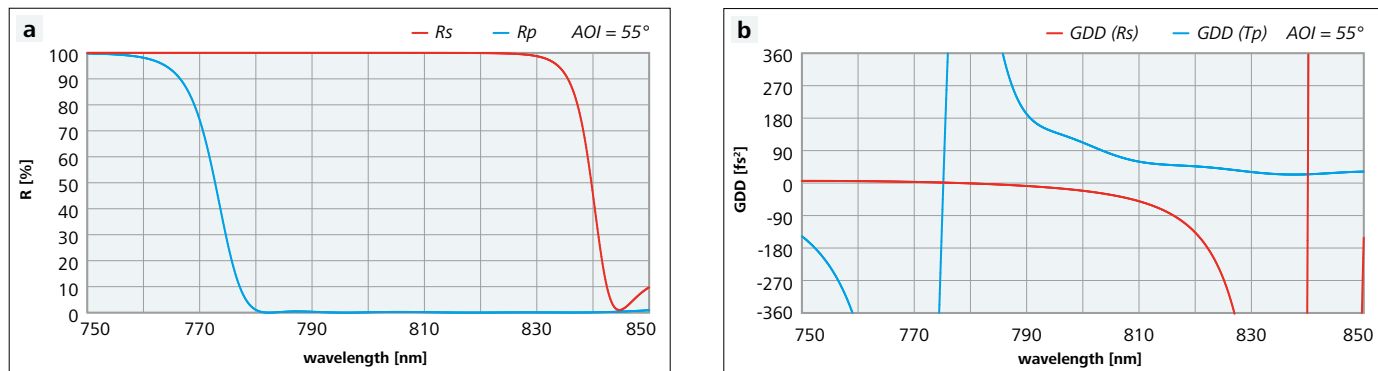


Figure 10: Reflectance and GDD spectra of a standard TFP (AOI = 55° to use the Brewster's angle for the transmitted p-polarized light)  
a) Reflectance vs. wavelength  
b) GDD vs. wavelength

Thin Film Polarizers for AOI = 65°

The bandwidth of thin film polarizers can be extended if large angles of incidence are used. As shown in figure 11a polarizer bandwidth as large as 100 nm can be achieved. However, this is combined with a reduced reflectance for the s-polarized light.

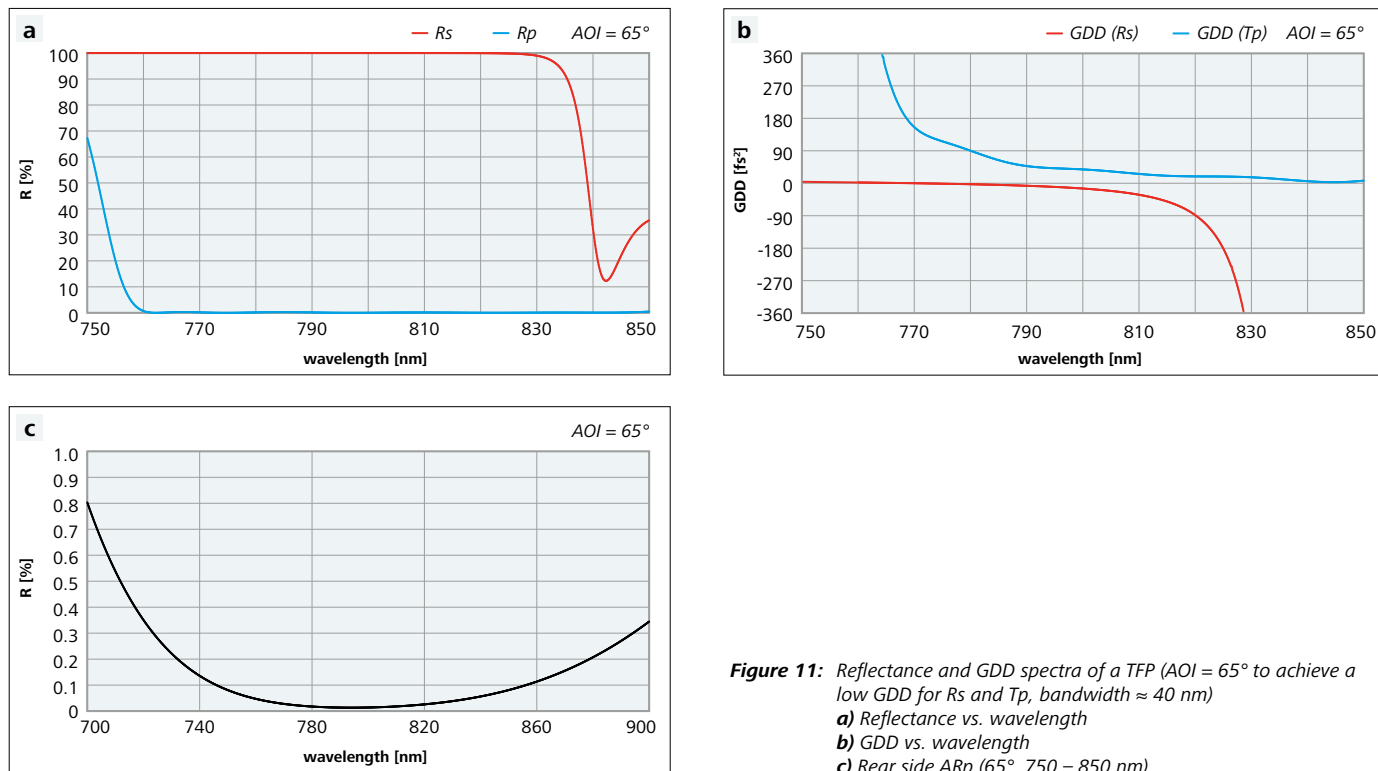
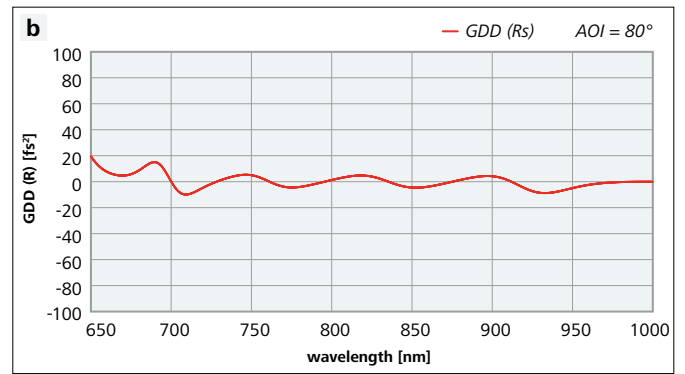
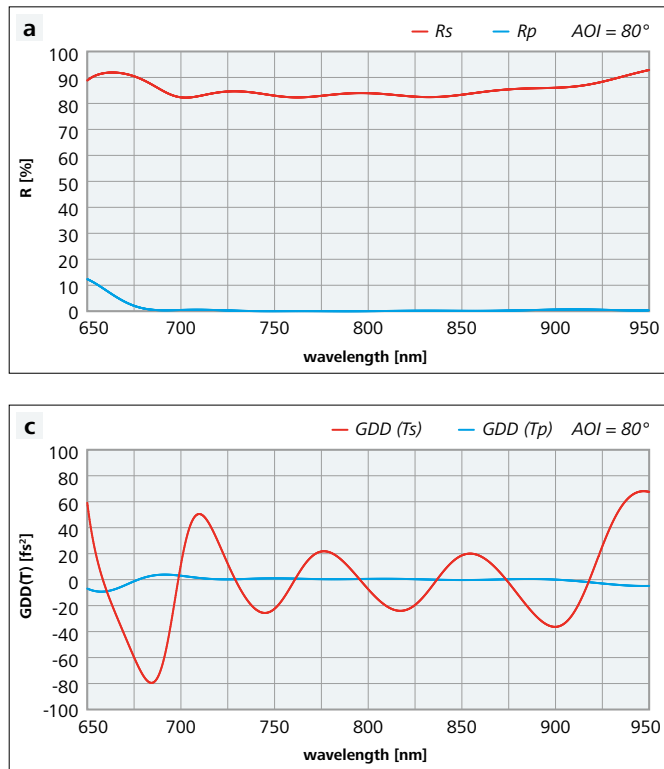


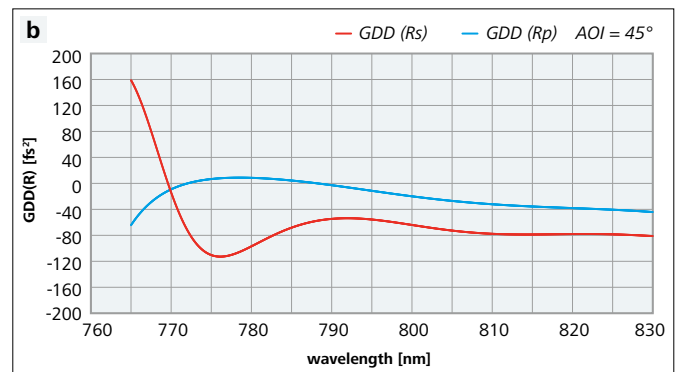
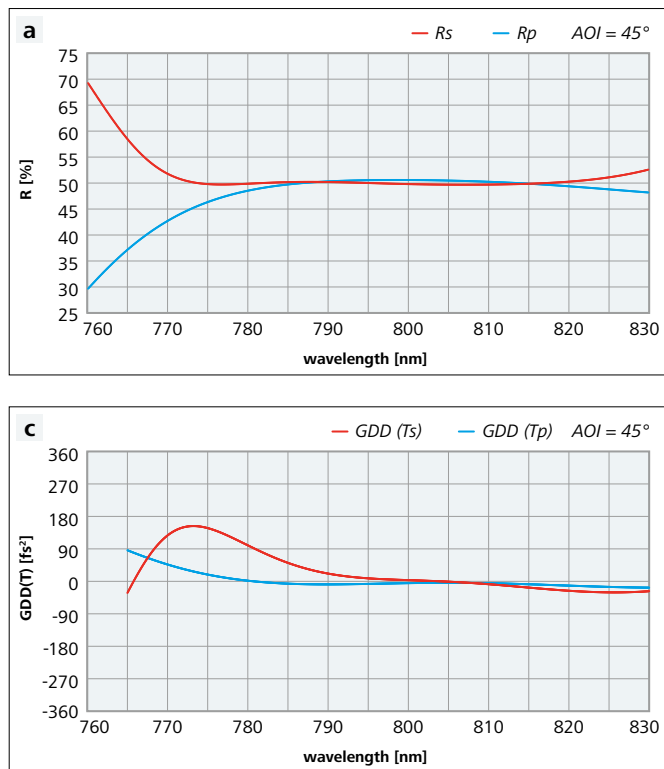
Figure 11: Reflectance and GDD spectra of a TFP (AOI = 65° to achieve a low GDD for Rs and Tp, bandwidth ≈ 40 nm)  
a) Reflectance vs. wavelength  
b) GDD vs. wavelength  
c) Rear side ARp (65°, 750 – 850 nm)

Thin Film Polarizers for AOI = 80°



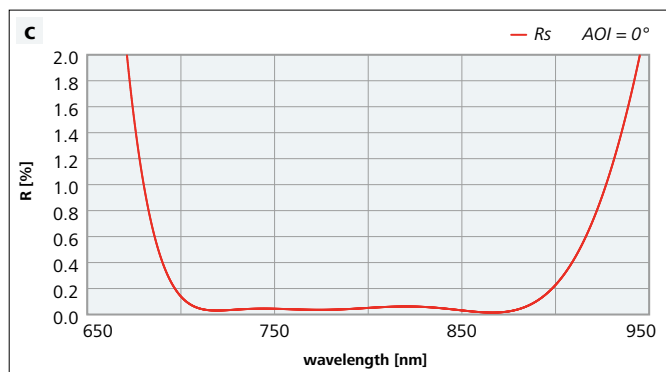
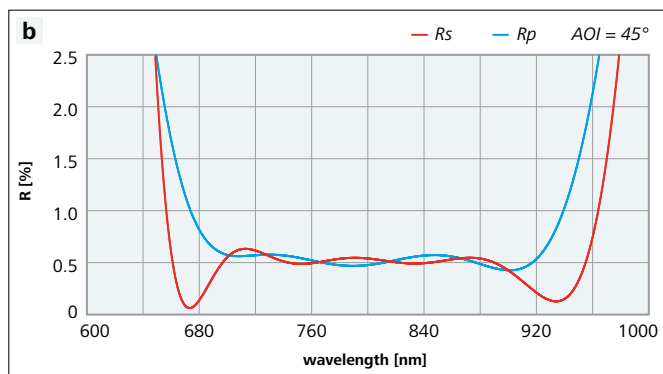
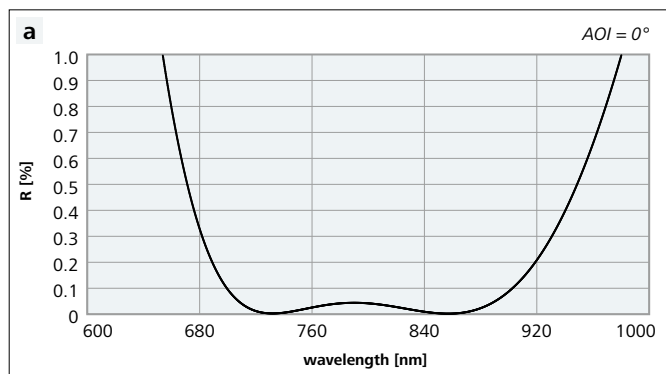
**Figure 12:** Reflectance and GDD spectra of a TFP (AOI = 80°, lower  $R_s$ -value to achieve a low GDD for  $R_s$  and  $T_p$ , bandwidth  $\approx$  150 nm)  
**a)** Reflectance vs. wavelength  
**b)** GDD of the reflected light vs. wavelength  
**c)** GDD of the transmitted light vs. wavelength

Non-polarizing Beam Splitters for AOI = 45°



**Figure 13:** Reflectance and GDD spectra of a non-polarizing beam splitter  
**a)** Reflectance vs. wavelength  
**b)** GDD of the reflected light vs. wavelength  
**c)** GDD of the transmitted light vs. wavelength

Antireflection Coatings



**Figure 14:** Reflectance of different antireflection coatings  
**a)**  $AOI = 0^\circ$   
**b)**  $AOI = 45^\circ$   $R_s = R_p \approx 0.5\%$   
**c)**  $AOI = 45^\circ$   $R_s < 0.2\%$  (only possible for s- or p-polarized light)

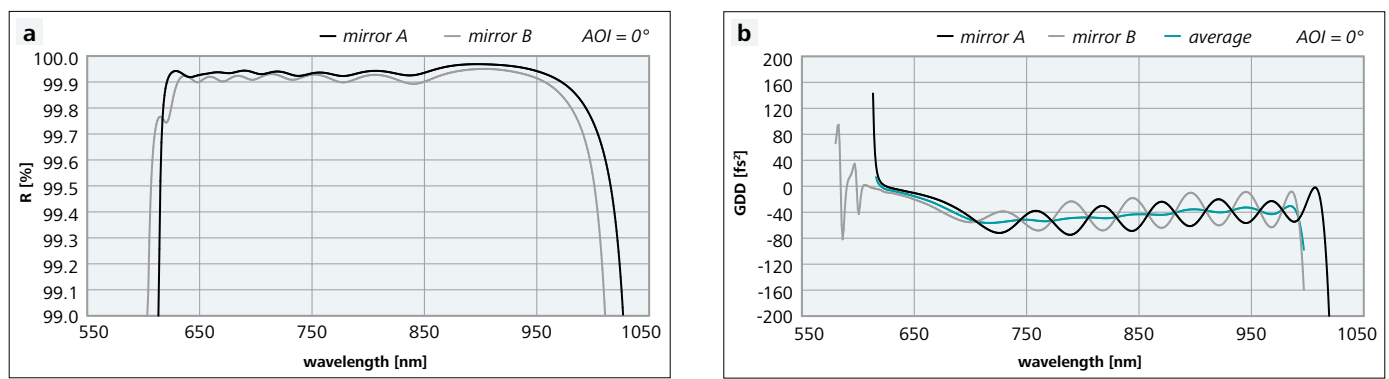
Broadband antireflection coatings for  $AOI = 0^\circ$  or a single polarization at  $AOI > 0^\circ$  with  $R < 0.1\%$  on request.

## Broadband Ultrafast Laser Optics (200 – 300 nm Bandwidth)

- The coatings shown here are calculated for the wavelength range 700 – 1000 nm. Similar coatings are available for 600 – 900 nm and 650 – 950 nm.
- Very high reflectance of the mirrors ( $R > 99.8\%$  ...  $R > 99.95\%$  depending on the design)
- Center wavelength, bandwidth, GD, GDD and TOD according to customer specifications
- Spectral tolerance  $\pm 1\%$
- In-house design calculation and GDD measurement capabilities
- GDD measurement reports are included in the delivery

<b>LIDT Info</b>
$\approx 0.1 \text{ J/cm}^2$ , 800 nm, 150 fs
Measurements were performed at Laser Zentrum Hannover

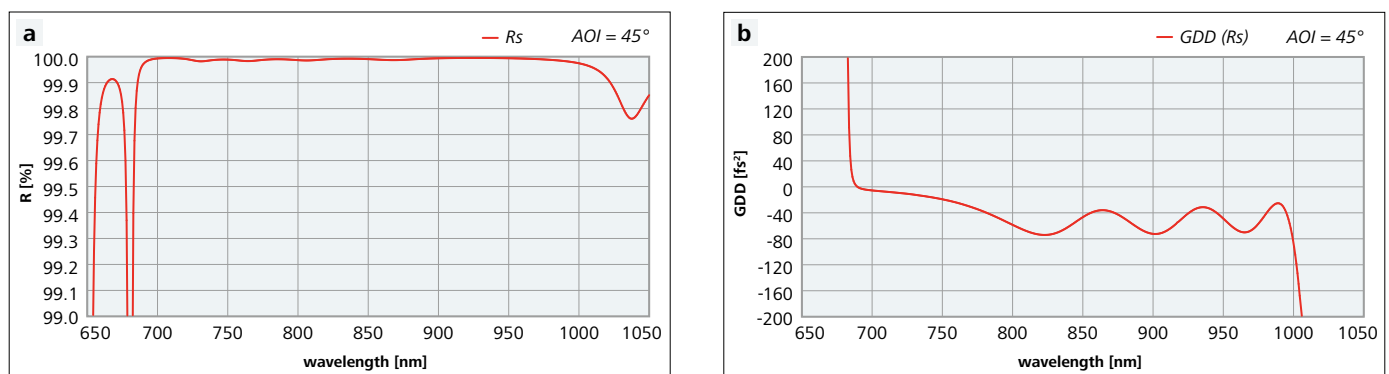
### Mirror Pairs for AOI = 0°



**Figure 1:** Reflectance and GDD spectra of a negative dispersion laser mirror pair  
 a) Reflectance vs. wavelength  
 b) GDD vs. wavelength

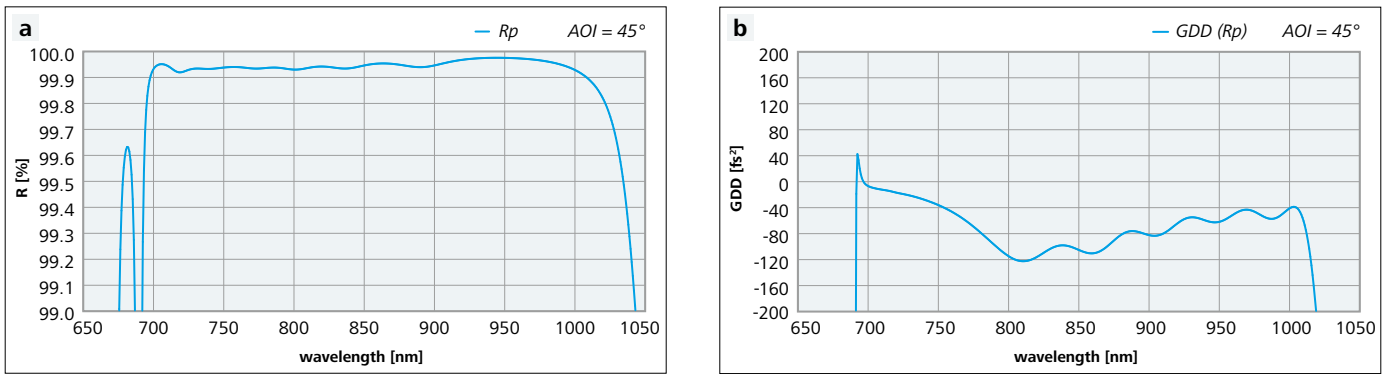
Mirror pairs show a very smooth average GDD spectrum, although the single broadband mirrors exhibit strong GDD oscillations. Pump mirror pairs, i.e. mirror pairs with at least one mirror showing high transmittance between 514 – 532 nm, are also available.

### Turning Mirrors for s-polarized Light at AOI = 45°



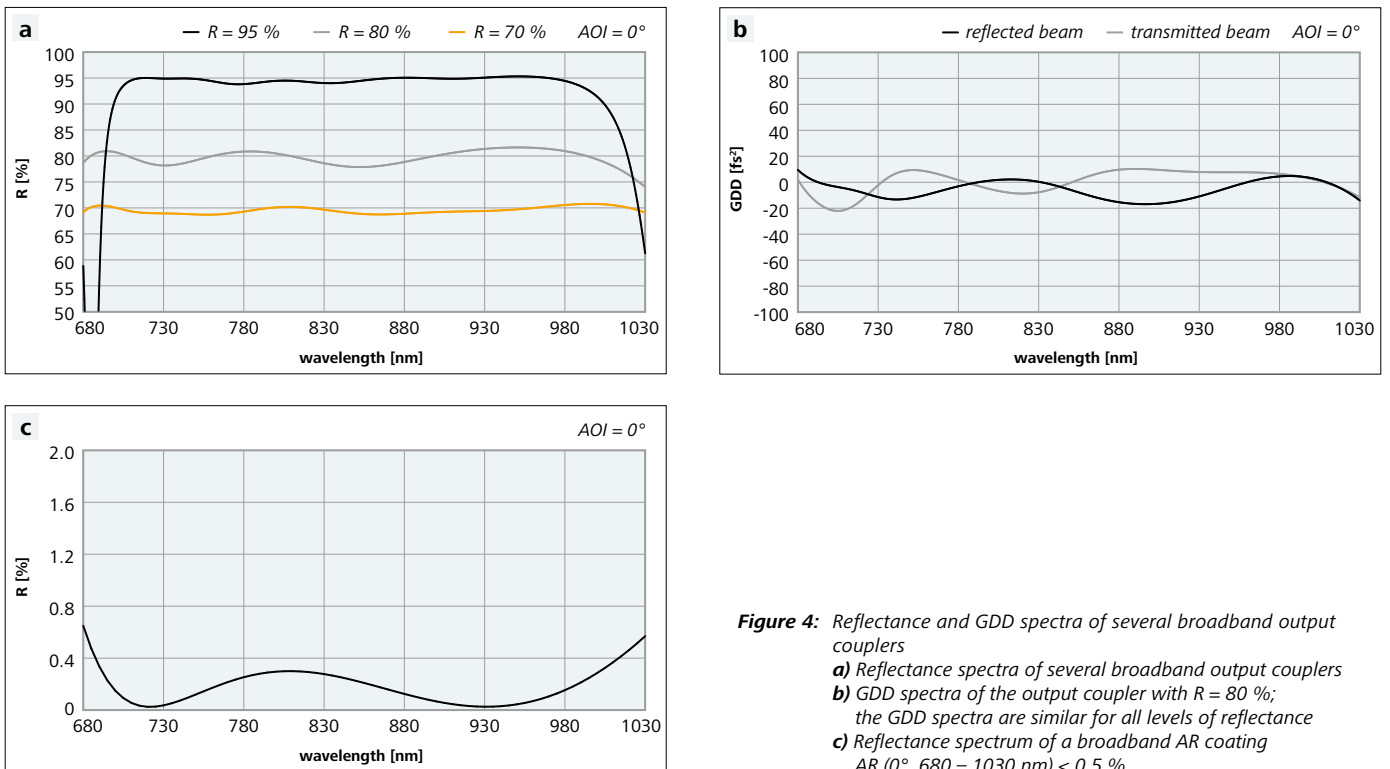
**Figure 2:** Reflectance and GDD spectra of a broadband turning mirror for s-polarized light  
 a) Reflectance vs. wavelength  
 b) GDD vs. wavelength

Turning Mirrors for p-polarized Light at AOI = 45°



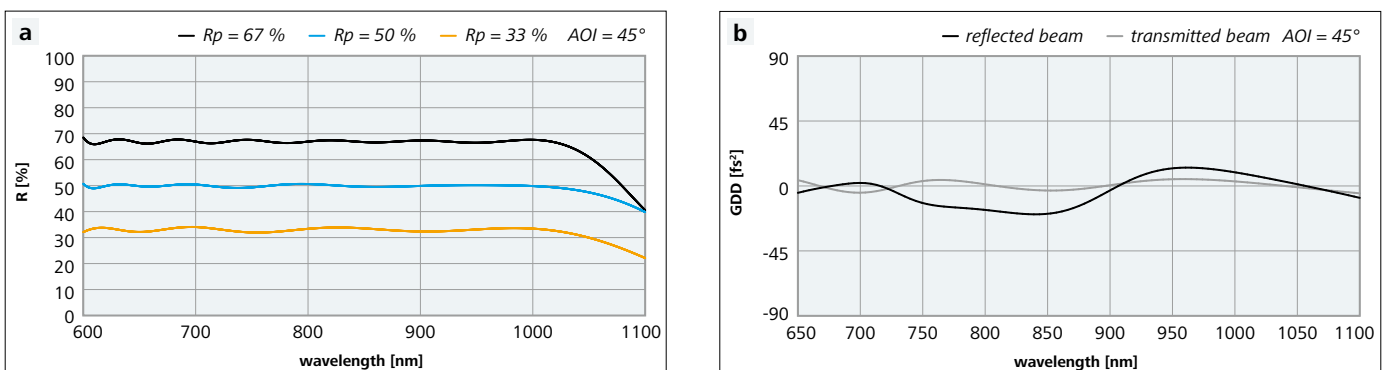
**Figure 3:** Reflectance and GDD spectra of a broadband turning mirror for p-polarized light  
**a)** Reflectance vs. wavelength  
**b)** GDD vs. wavelength

Output Couplers for AOI = 0°

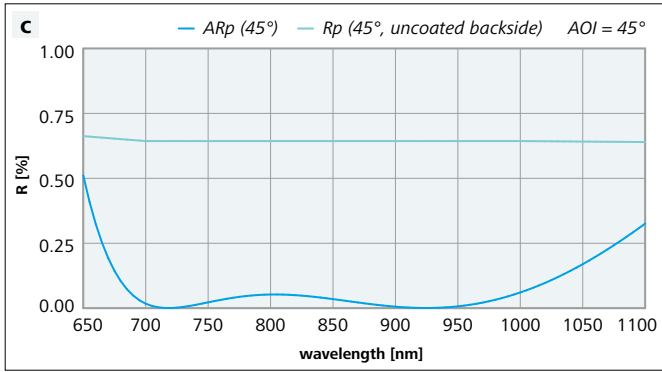


**Figure 4:** Reflectance and GDD spectra of several broadband output couplers  
**a)** Reflectance spectra of several broadband output couplers  
**b)** GDD spectra of the output coupler with R = 80 %; the GDD spectra are similar for all levels of reflectance  
**c)** Reflectance spectrum of a broadband AR coating AR (0°, 680 – 1030 nm) < 0.5 %

Beam Splitters for p-polarized Light at AOI = 45°

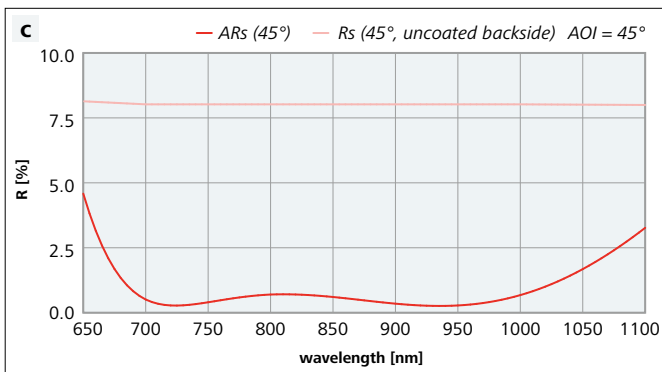
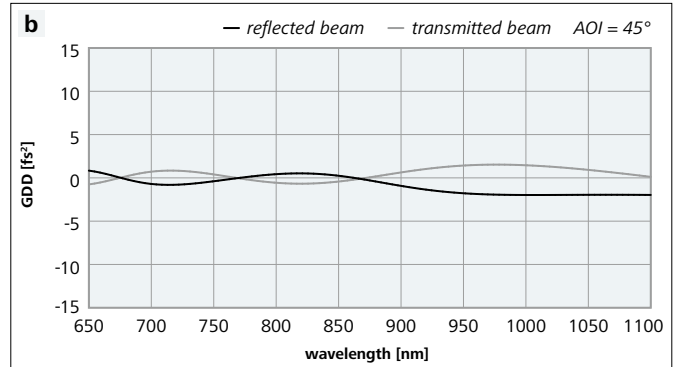
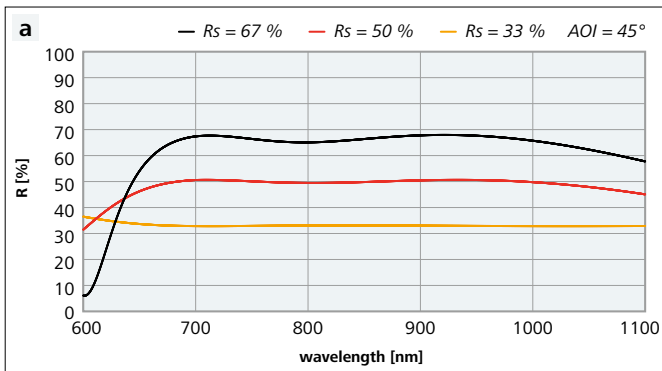


Please turn page for image description



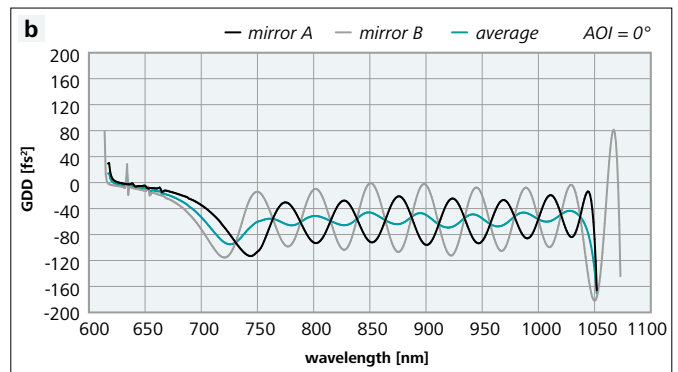
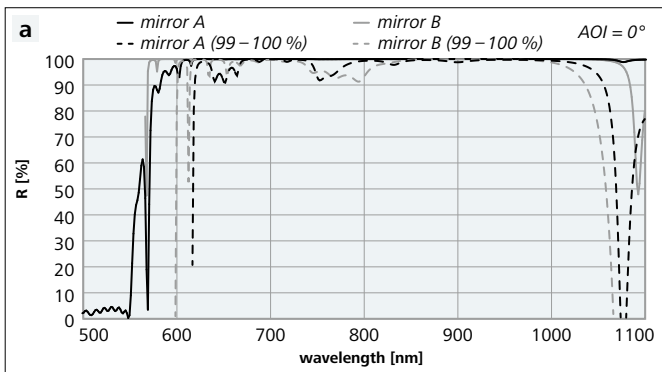
**Figure 5:** Reflectance and GDD spectra of several broadband beam splitters for p-polarized light  
**a)** Reflectance of several broadband beam splitters for p-polarization  
**b)** GDD spectra for the 50 % beam splitter  
**c)** Reflectance spectrum of a broadband AR coating for p-polarized light

Beam Splitters for s-polarized Light at AOI = 45°



**Figure 6:** Reflectance and GDD spectra of several broadband beam splitters for s-polarized light  
**a)** Reflectance of several broadband beam splitters for s-polarization  
**b)** GDD spectra for the 50 % beam splitter  
**c)** Reflectance spectrum of a broadband AR coating for s-polarized light

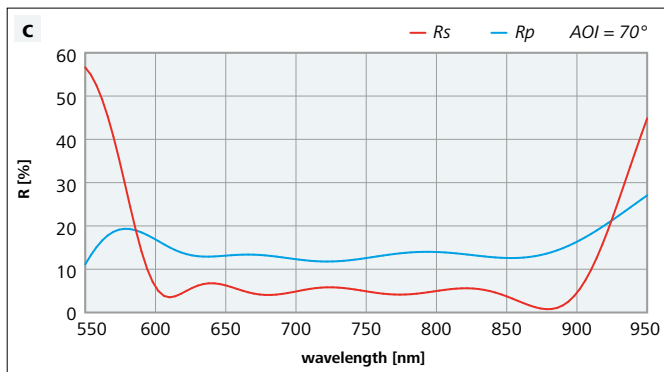
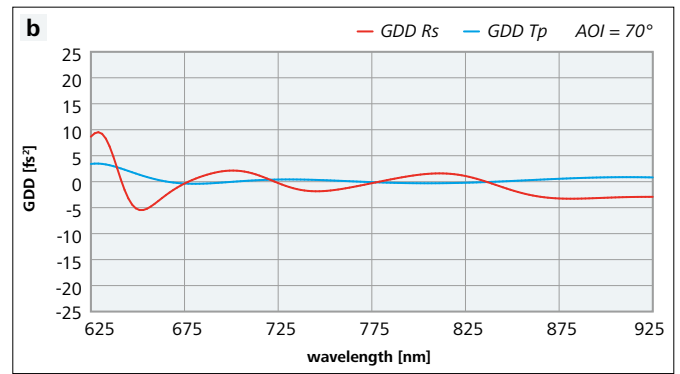
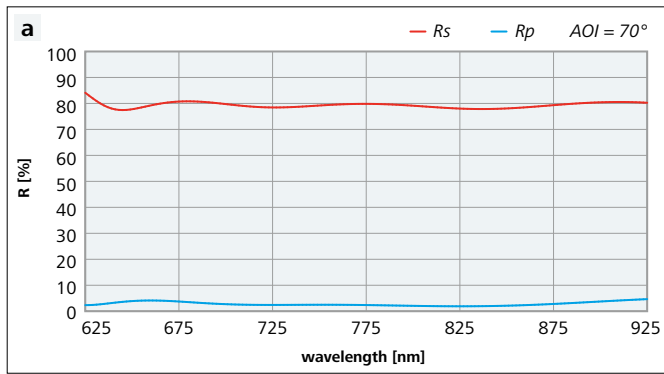
Negative Dispersion Pump Mirror Pairs for AOI = 0°



**Figure 7:** Reflectance and GDD spectra of a negative dispersion pump mirror pair (mirror B without HT-option)  
**a)** Reflectance vs. wavelength  
**b)** GDD vs. wavelength

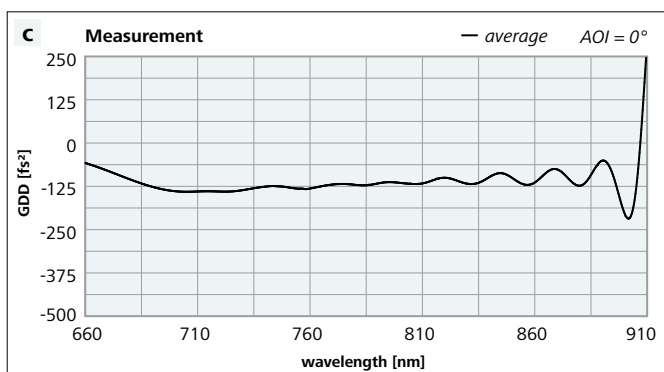
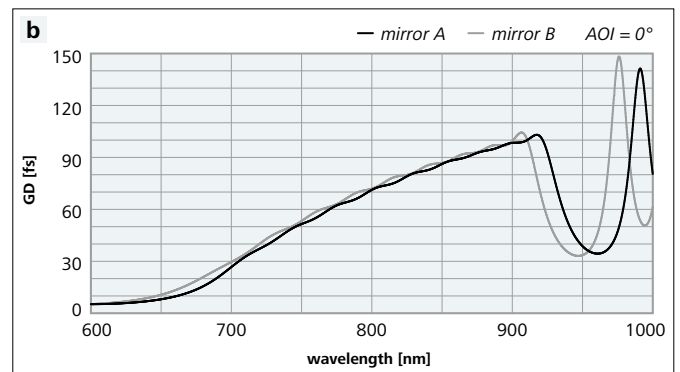
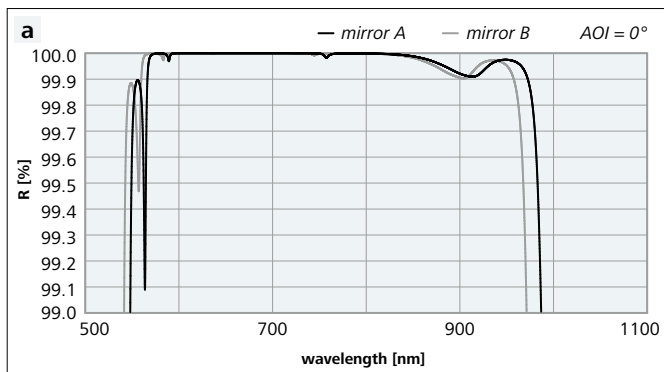


Thin Film Polarizers for AOI = 70°



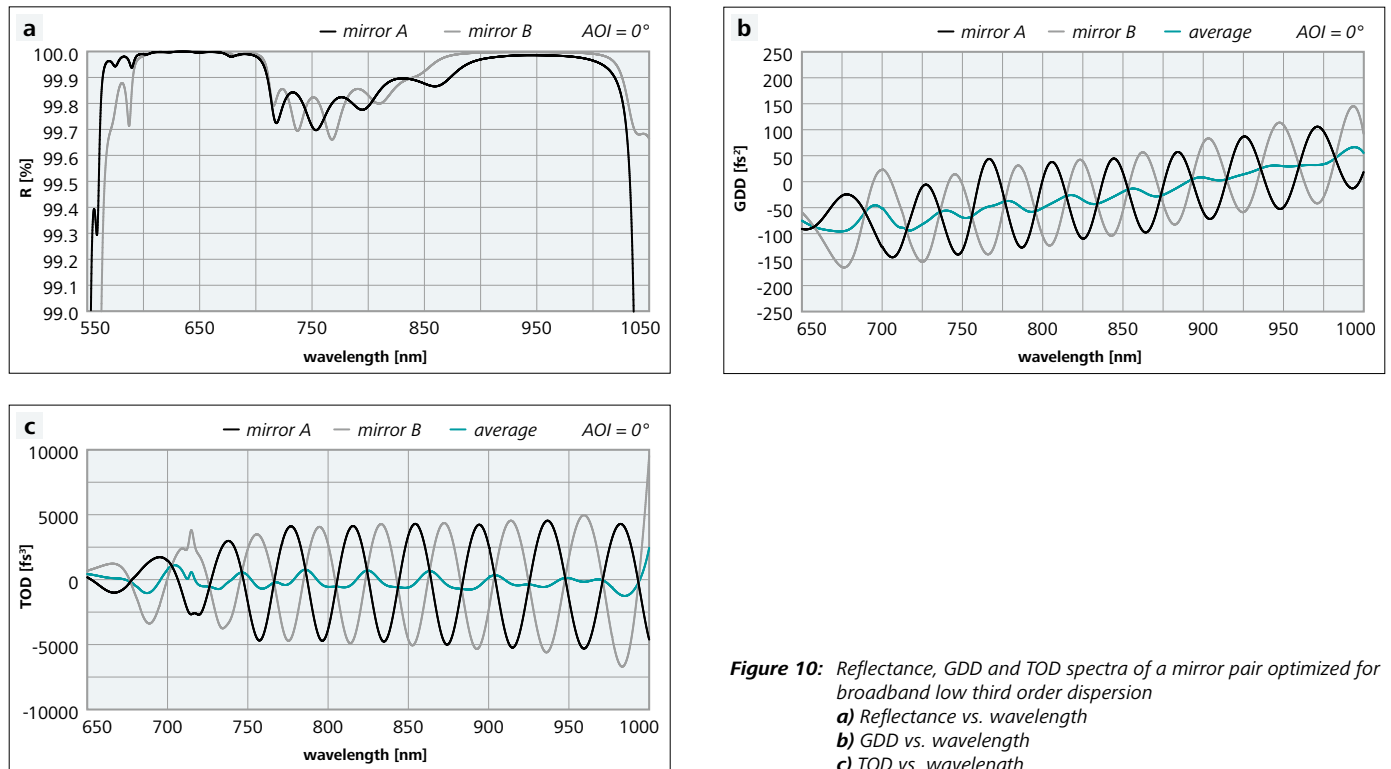
**Figure 8:** Reflectance and GDD spectra of a TFP (AOI = 70°), lower Rs to achieve “zero” GDD for Rs and Tp, bandwidth ≈ 300 nm  
**a)** Reflectance vs. wavelength  
**b)** GDD vs. wavelength  
**c)** Rear side AR coating for s-polarized light. Please note that this coating results in  $R \approx 15\%$  for the p-polarized component. As an AR coating for the p-polarization LAYERTEC suggests the use of the design from figure 8a.

High Negative Dispersion Mirror Pairs for AOI = 0°



**Figure 9:** Reflectance, GD and GDD spectra of a high dispersion mirror pair with a bandwidth of 250 nm and an average GDD of  $-180 \text{ fs}^2 \pm 40 \text{ fs}^2$  per bounce in the 800 nm range  
**a)** Reflectance vs. wavelength  
**b)** Calculated GD vs. wavelength  
**c)** Measured GDD vs. wavelength

**Mirror Pairs with Optimized Third Order Dispersion for AOI = 0°**



**Figure 10:** Reflectance, GDD and TOD spectra of a mirror pair optimized for broadband low third order dispersion  
**a)** Reflectance vs. wavelength  
**b)** GDD vs. wavelength  
**c)** TOD vs. wavelength

The mirror pair shows very smooth GDD and TOD spectra, although the single mirrors exhibit considerable GDD and TOD oscillations.

**Special Features**

- GDD of high dispersive mirrors between -50 fs<sup>2</sup> and -500 fs<sup>2</sup>
- Very high reflectance
- Center wavelength, bandwidth and GDD according to customer specifications
- Please note that bandwidth and GDD are closely connected. High values of negative GDD result in a very narrow bandwidth
- Spectral tolerance ± 1 %
- In-house design calculation and measurement capabilities (GDD 250 – 1700 nm, reflectance measurement by CRD 220 – 1800 nm)

<b>LIDT Info</b>
≈ 0.1 J/cm <sup>2</sup> , 800 nm, 150 fs
Measurements were performed at Laser Zentrum Hannover

# Octave Spanning Ultrafast Laser Optics (400 – 500 nm Bandwidth)

- The coatings shown here are calculated for the wavelength range of one octave (e.g. 550 – 1100 nm). Similar coatings are possible for other wavelength ranges.
- Center wavelength, bandwidth, GDD and reflectance of output couplers and beam splitters according to customer specifications
- Spectral tolerance  $\pm 1\%$
- In-house design calculation and GDD measurement capabilities
- GDD measurement reports are included in the delivery

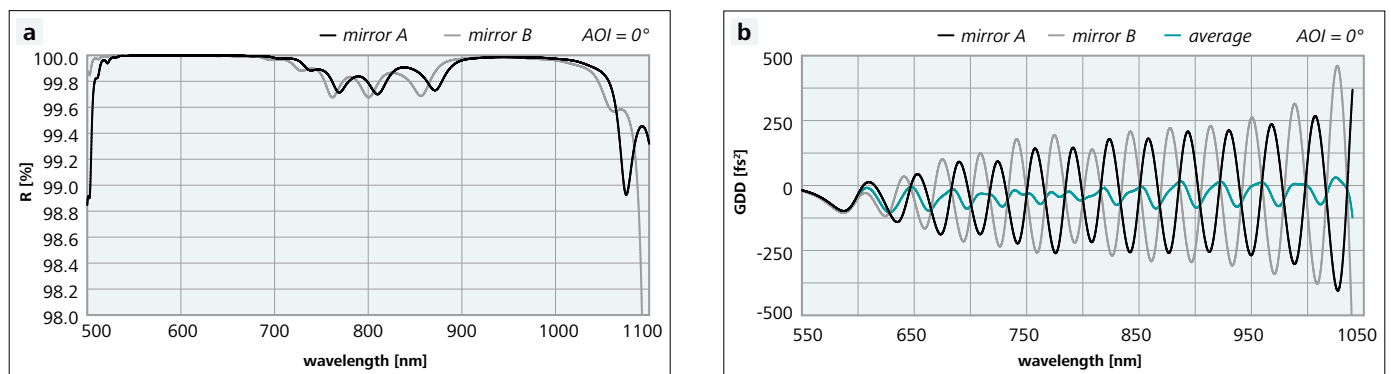
### LIDT Info

$\approx 0.1 \text{ J/cm}^2$ , 800 nm, 150 fs

Measurements were performed at Laser Zentrum Hannover

## Negative Dispersion Laser Mirror Pairs for AOI = 0°

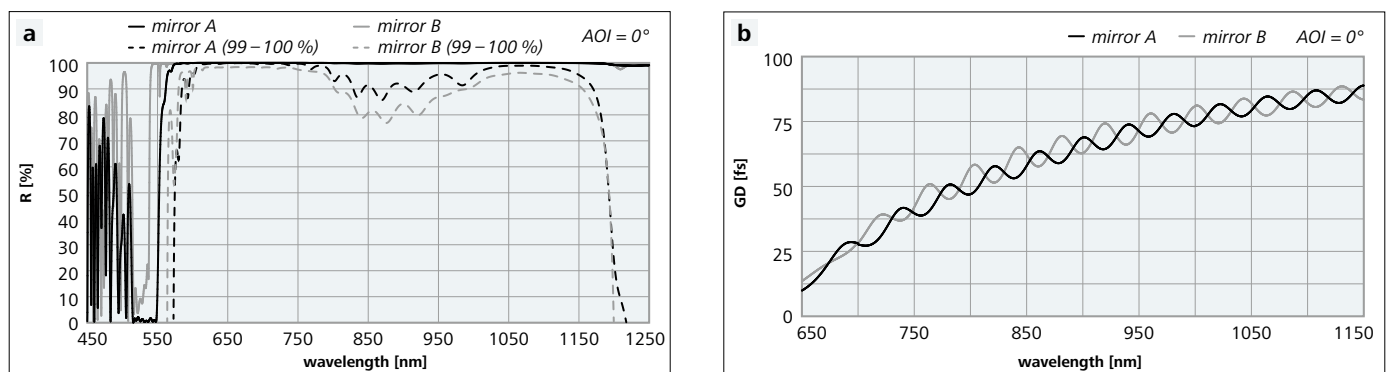
Mirror pairs designed by LAYERTEC show a very smooth average GDD spectrum even though the single broadband mirrors exhibit strong GDD oscillations.



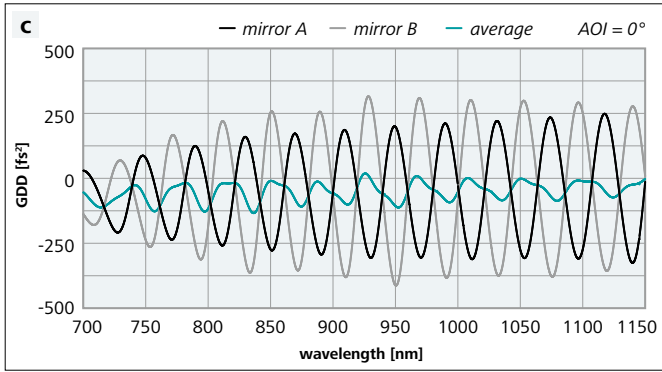
**Figure 1:** Reflectance and GDD spectra of an ultra broadband negative dispersion laser mirror pair  
**a)** Reflectance vs. wavelength  
**b)** GDD vs. wavelength

## Negative Dispersion Pump Mirror Pairs for AOI = 0°

The pump mirror pair consists of two mirrors which both show a region of high transmittance around 500 nm.

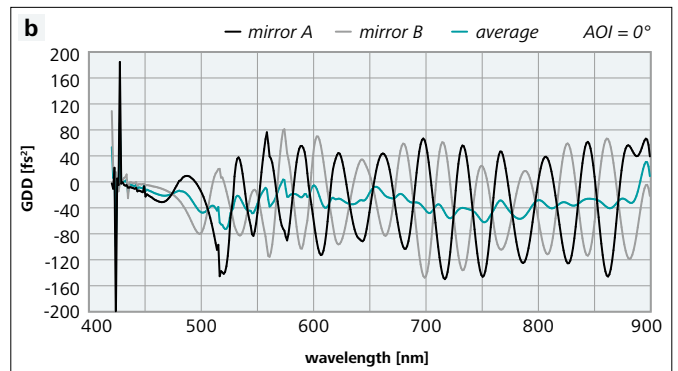
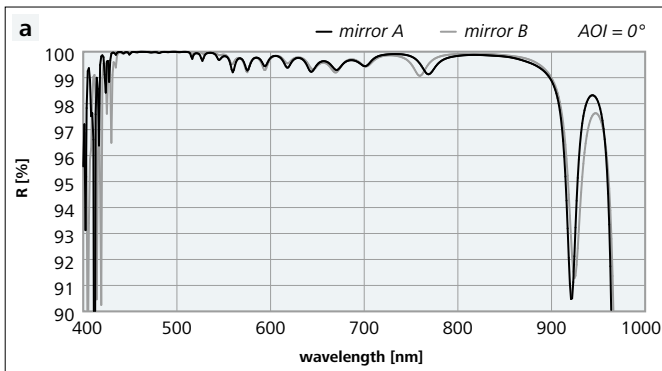


Please turn page for image description



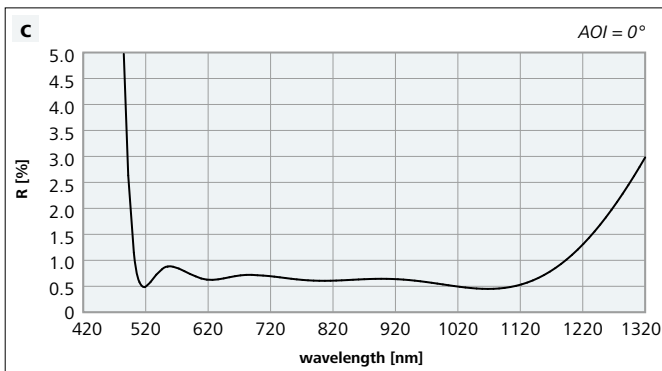
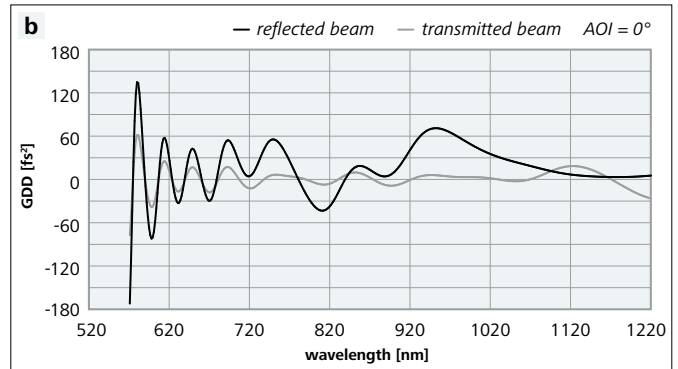
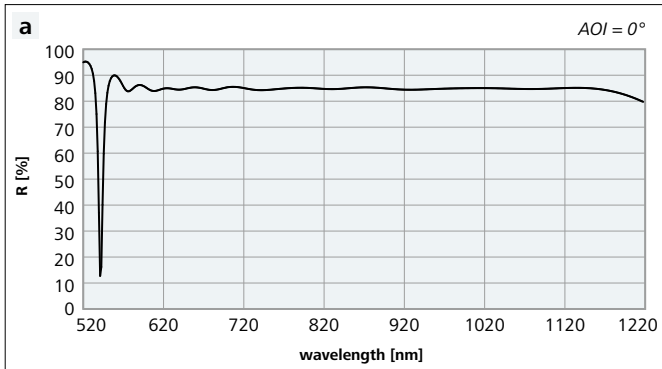
**Figure 2:** Reflectance and GDD spectra of an ultra broadband negative dispersion pump mirror pair  
**a)** Reflectance vs. wavelength  
**b)** GD vs. wavelength  
**c)** GDD vs. wavelength

Negative Dispersion Turning Mirror Pairs for p-polarized Light for AOI = 0°



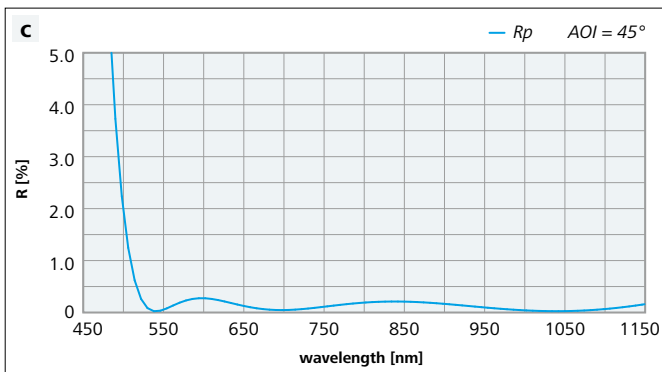
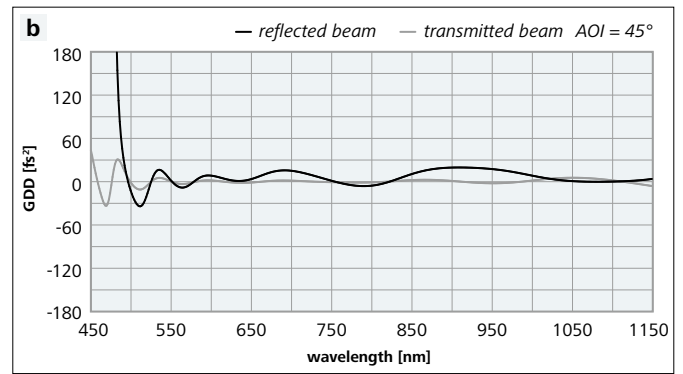
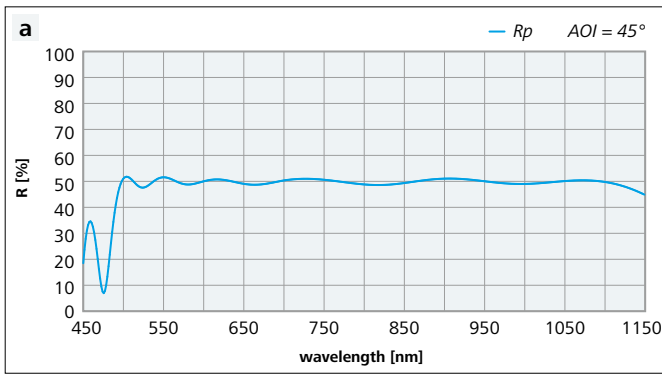
**Figure 3:** Reflectance and GDD spectra of an ultra broadband turning mirror pair for p-polarized light  
**a)** Reflectance vs. wavelength  
**b)** GDD vs. wavelength

Output Couplers for AOI = 0°



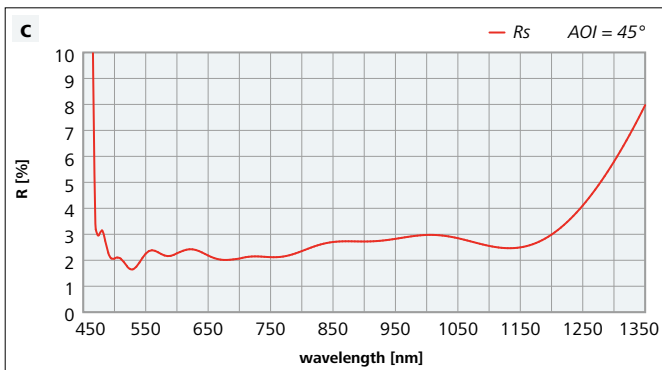
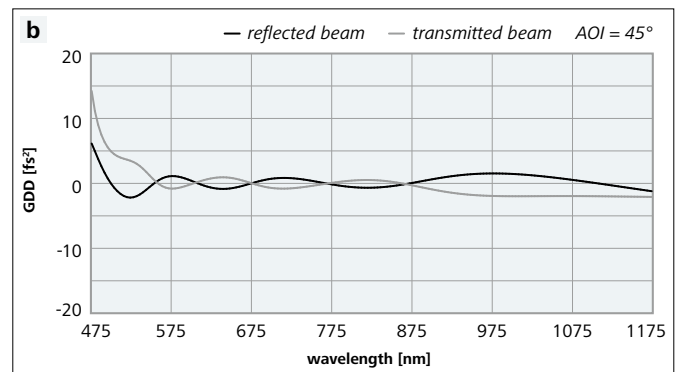
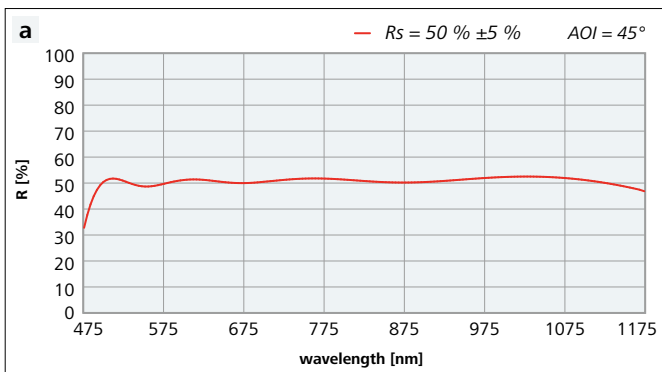
**Figure 4:** Reflectance and GDD spectra of an ultra broadband output coupler with  $R = 85\% \pm 3\%$   
**a)** Reflectance vs. wavelength  
**b)** GDD vs. wavelength  
**c)** Rear side octave spanning AR coating

Beam Splitters for p-polarized Light at AOI = 45°



**Figure 5:** Reflectance and GDD spectra of an ultra broadband beam splitter for p-polarized light with  $R_p = 50\% \pm 4\%$   
**a)** Reflectance vs. wavelength  
**b)** GDD vs. wavelength  
**c)** Rear side octave spanning AR coating for p-polarized light

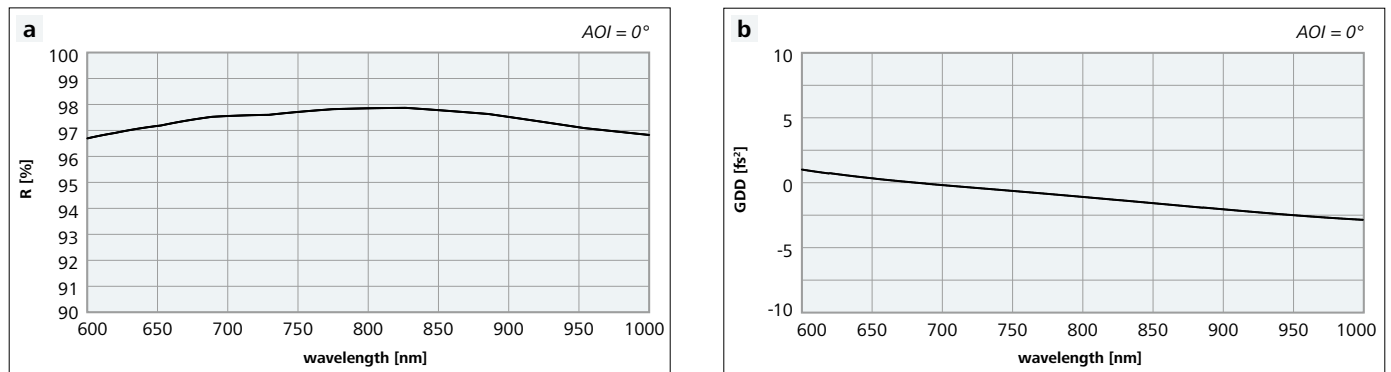
Beam Splitters for s-polarized Light at AOI = 45°



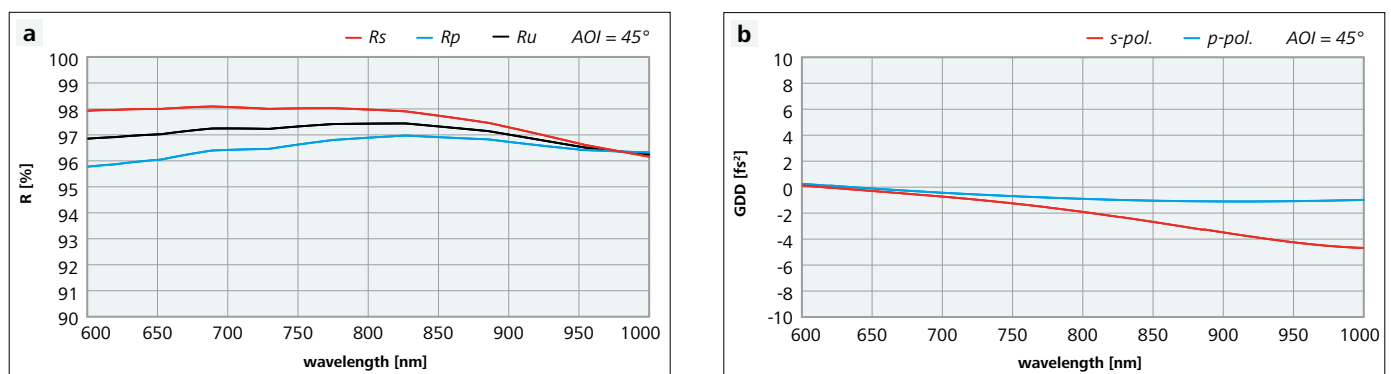
**Figure 6:** Reflectance and GDD spectra of an ultra broadband beam splitter for s-polarized light with  $R_s = 50\% \pm 5\%$   
**a)** Reflectance vs. wavelength  
**b)** GDD vs. wavelength  
**c)** Rear side octave spanning AR coating for s-polarized light

# Silver Mirrors for Ultrafast Lasers (550 – 1100 nm)

## Silver Mirrors Optimized for Laser Applications



**Figure 1:** Reflectance and GDD spectra of a silver mirror optimized for use with ultrafast-lasers in the wavelength range 600 – 1000 nm (AOI = 0°)  
**a)** Reflectance vs. wavelength  
**b)** GDD vs. wavelength



**Figure 2:** Reflectance and GDD spectra of a silver mirror optimized for use with ultrafast-lasers in the wavelength range 600 – 1000 nm (AOI = 45°)  
**a)** Reflectance vs. wavelength  
**b)** GDD vs. wavelength

### Special Features

- High reflectance in the VIS and NIR
- Very broad reflectance band with  $GDD \approx 0 \text{ fs}^2$
- Silver mirrors with defined transmittance (e.g. 0.01 %) exhibit high LIDT (see table) and the same reflectance and GDD values as shown in figure 1 and figure 2
- Extremely low scattering losses (total scattering  $TS \approx 30 \text{ ppm}$  in the VIS and NIR)
- Lifetimes of more than 10 years have been demonstrated in normal atmosphere
- Highly stable optical parameters due to sputtered protective layers
- Easy to clean (tested according to MIL-M-13508C § 4.4.5)

### Stock of standard components

- Standard and fs-optimized protected silver on substrates with  $\varnothing = 12.7 \text{ mm}$ ,  $\varnothing = 25 \text{ mm}$  and  $\varnothing = 50 \text{ mm}$ :
  - Plane
  - Plano/concave and plano/convex with a variety of radii between 10 mm and 10 000 mm
- Other sizes, shapes, radii and coatings for other wavelength ranges on request

**Table 1:** Technical data of silver mirrors for ultrafast lasers

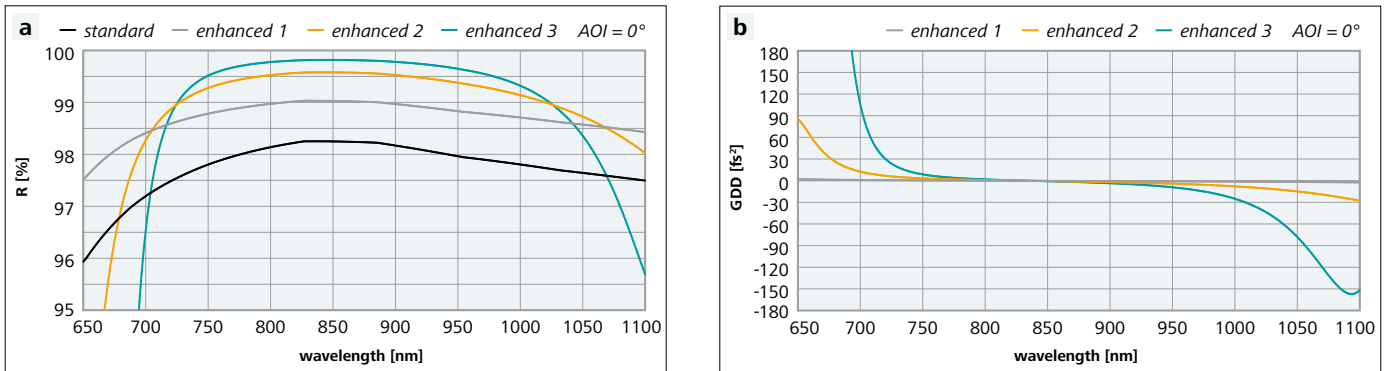
Coating	Reflectance*	Wavelength Range	LIDT**
fs-optimized protected silver	R = 96.5 ... 98.5 %	600 – 1000 nm	0.38 J/cm <sup>2</sup>
Enhanced silver 800 nm	R > 99 %	700 – 900 nm	0.37 J/cm <sup>2</sup>
Broadband enhanced silver	R = 98 ... 98.5 %	600 – 1200 nm	0.24 J/cm <sup>2</sup>
Partially transparent silver	R = 96.5 ... 98.5 %	600 – 1000 nm	0.22 J/cm <sup>2</sup>

\* For unpolarized light at AOI = 45°

\*\* Measurements were performed at Laser Zentrum Hannover according to ISO 11254 measurement conditions: pulse duration: 150 fs, 30000 pulses, repetition rate: 1 kHz,  $\lambda = 800 \text{ nm}$

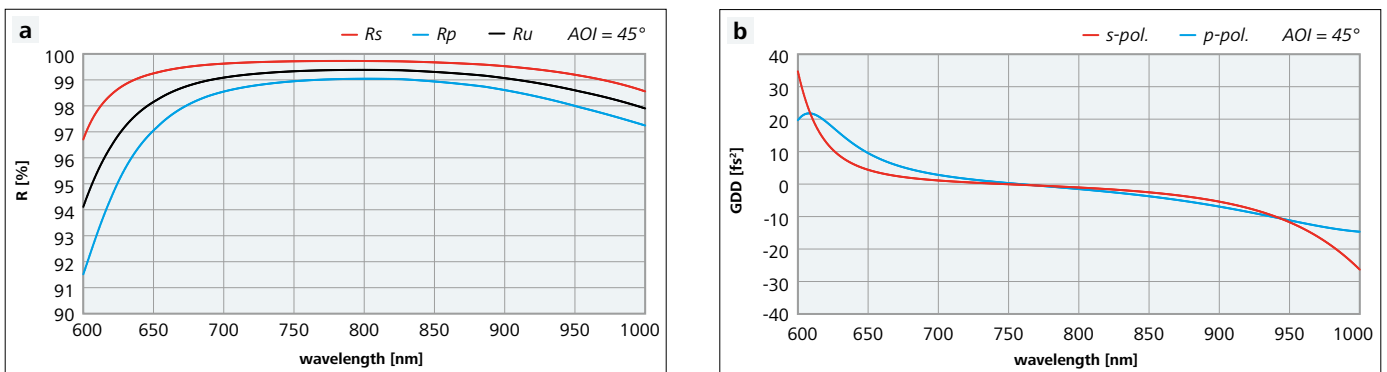
### Silver Mirrors with Enhanced Reflectance

The reflectance of silver mirrors can be enhanced by an additional dielectric coating. The bandwidth of the enhanced reflectance must be exactly specified. Outside this band, the reflectance of the mirror may be lower than that of a standard silver mirror. For the use with fs-lasers, the additional dielectric coating must be optimized for high reflectance and low GDD. The following figures show examples for silver mirrors with enhanced reflectance at a specified wavelength (figure 3 and figure 4) and over the wavelength range of the Ti:Sapphire laser (figure 5). Enhanced silver mirrors can also be designed for a defined transmittance (e.g.  $T = 0.01\%$ ).



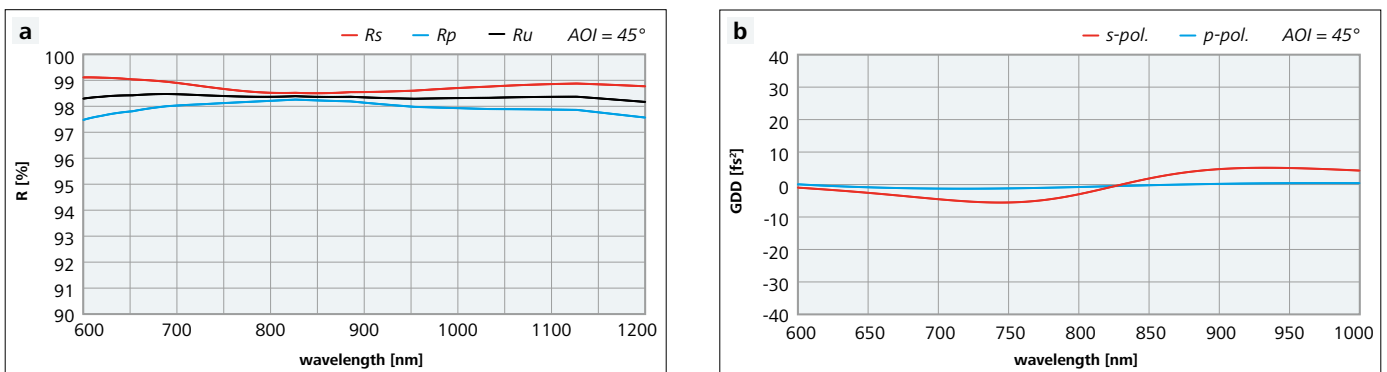
**Figure 3:** Reflectance and GDD spectra of silver mirrors with different designs for enhanced reflectance around 850 nm ( $\text{AOI} = 0^\circ$ )

- a) Reflectance vs. wavelength
- b) GDD vs. wavelength



**Figure 4:** Reflectance and GDD spectra of a silver mirror with enhanced reflectance around 800 nm ( $\text{AOI} = 45^\circ$ )

- a) Reflectance vs. wavelength
- b) GDD vs. wavelength



**Figure 5:** Reflectance and GDD spectra of a silver mirror with enhanced reflectance in the wavelength range 600 – 1200 nm ( $\text{AOI} = 45^\circ$ )

- a) Reflectance vs. wavelength
- b) GDD vs. wavelength

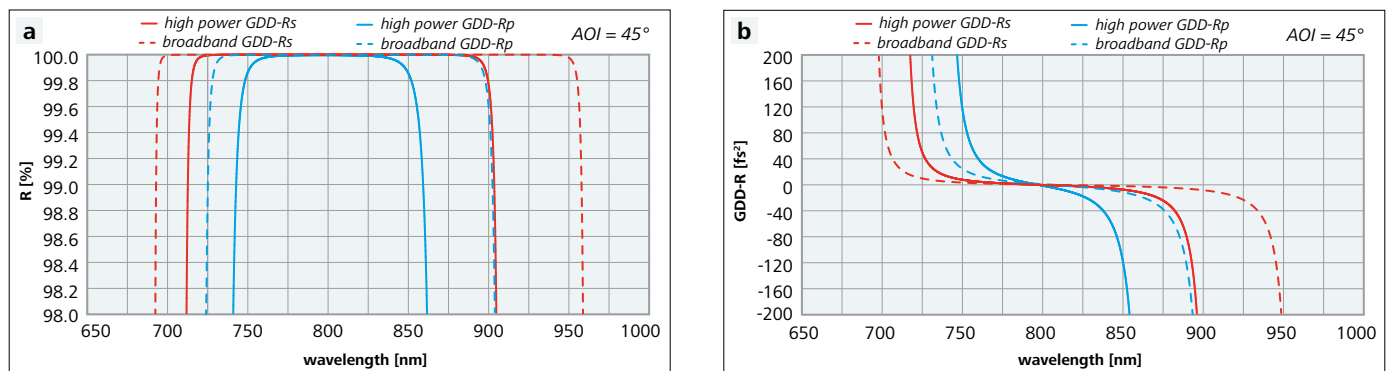
## High Power Ultrafast Laser Optics (550 – 1100 nm)

Ultrafast lasers are widely used in measurement applications and materials science. Ultrafast lasers enable the machining of metals as well as of dielectric materials by cold, i.e. non-thermal, processes. The most important feature of these treatment steps is the avoidance of melt. That is why pieces machined with ultrafast lasers are of high accuracy and do not require mechanical postprocessing. The demands for efficient production processes drive the development of high power fs lasers. In most cases, these lasers show pulse lengths between 100 fs and 1 ps.

Moreover, high power ultrafast lasers with power levels in the terawatt and petawatt range become more and more important in basic research on light material-interaction, particle physics and even for medical applications. The pulse duration of these lasers is considerably shorter than that of lasers for material processing. Typical pulse durations range from 20 fs to 50 fs.

The laser types mentioned above require optics with high laser-induced damage thresholds (LIDT). High power coatings for ultrafast lasers were the topic of a number of scientific investigations in the last years [1, 2]. Research institutes as well as optics manufacturers have spent much effort on the improvement of the LIDT of fs laser optics. LAYERTEC has dealt with this issue for more than 20 years.

The main result of these investigations mentioned above was that the LIDT of optical coatings in the fs regime is strongly related to the band gap of the coating materials as well as the coating designs. Materials with larger band gaps exhibit larger LIDT. However, there is a trade-off between damage threshold and bandwidth, as large band gaps also translate into a smaller difference of the refractive indices. Thus, turning mirrors made of these materials only have a bandwidth of about 100 nm for p-polarized light at AOI = 45°. This bandwidth is sufficient for pulse lengths as low as 25 fs. Please note that all LAYERTEC high power designs are optimized for GDD < 50 fs<sup>2</sup>.



**Figure 1:** Reflectance and GDD spectra of a high power ultrafast laser turning mirror (solid lines) and a broadband ultrafast laser turning mirror (dashed lines)  
**a)** Reflectance vs. wavelength  
**b)** GDD vs. wavelength

In contrast, materials with a large difference of the refractive indices may be used in order to achieve large bandwidths. Designs for standard low-GDD components exhibit medium LIDT values, whereas broadband designs result in low damage thresholds. This is also the case when considering mirrors with dispersion control, such as chirped mirror pairs or GTI mirrors. Here, bandwidth and phase requirements outweigh LIDT. However, depending on the complexity of the overall constraints, some optimization of damage thresholds may be possible.

The investigations have also shown that LAYERTEC's optimized silver mirrors possess significant LIDT values in the fs range. Another advantage of silver mirrors is their extremely broad zero-GDD reflectance band with reflectance up to 98.5 % at normal incidence. Even silver mirrors with a defined transmission of 0.01 % exhibit considerable damage thresholds, especially with respect to dielectric ultra broadband components. For more information on silver mirrors see page 52 f.

### References

- [1] B. Mangote, L. Gallais, M. Commandré, M. Mende, L. O. Jensen, H. Ehlers, M. Jupé, D. Ristau, A. Melnikaitis, J. Mirauskas, V. Sirutkaitis, S. Kicas, T. Tolenis, R. Drazdys: "Femto-second laser damage resistance of oxide and mixture oxide optical coatings"; Optics Letters 9 (Vol. 37), p. 1478-1480 (2012)
- [2] Raluca A. Negres, Christopher J. Stolz, Kyle R. P. Kafka, Enam A. Chowdhury, Matt Kirchner, Kevin Shea, Meaghan Daly: "40-fs broadband low dispersion mirror thin film damage competition"; Proceedings Volume 10014, Laser-Induced Damage in Optical Materials 2016, 100140E (2016)



Overview about Laser-Induced Damage Thresholds of Ultrafast Laser Optics

Table 1: Overview about LIDT data

Coating	Reflectance at 800 nm	LIDT	Pulse Duration, Repetition Rate
Single-wavelength AR coating**	< 0.2 %	1.10 J/cm <sup>2</sup> <sup>3)</sup> 1.20 J/cm <sup>2</sup> <sup>2)</sup>	42 fs, 1 kHz 1 ps, 1 kHz
Broadband AR coating**	< 0.5 %	1.20 J/cm <sup>2</sup> <sup>2)</sup>	1 ps, 1 kHz
Unprotected gold	97.5 %	0.33 J/cm <sup>2</sup> <sup>1)</sup> 0.33 J/cm <sup>2</sup> <sup>2)</sup>	50 fs, 1 kHz 150 fs, 1 kHz
fs-optimized silver	98.5 %	0.38 J/cm <sup>2</sup> <sup>1)</sup> 0.38 J/cm <sup>2</sup> <sup>2)</sup>	50 fs, 1 kHz 150 fs, 1 kHz
Enhanced silver (600 – 1200 nm)	98.5 %	0.24 J/cm <sup>2</sup> <sup>2)</sup>	150 fs, 1 kHz
Partially transparent silver (T = 0.01 % @ 800 nm)	98.5 %	0.22 J/cm <sup>2</sup> <sup>2)</sup>	150 fs, 1 kHz
High power mirror for fs pulses	> 99.5 %	0.90 J/cm <sup>2</sup> <sup>3)</sup> 3.60 J/cm <sup>2</sup> <sup>4)</sup>	42 fs, 1 kHz 70 fs, 10 Hz
Enhanced silver (800 nm)	99.7 %	0.37 J/cm <sup>2</sup> <sup>2)</sup>	150 fs, 1 kHz
Negative-dispersion mirrors*	> 99.9 %	0.10 J/cm <sup>2</sup> <sup>2)</sup>	150 fs, 1 kHz
Broadband low-GDD mirrors*	> 99.9 %	0.15 J/cm <sup>2</sup> <sup>1)</sup> 0.10 J/cm <sup>2</sup> <sup>2)</sup>	6 fs, 4 kHz 150 fs, 1 kHz
Standard low-GDD mirrors	> 99.9 %	0.50 J/cm <sup>2</sup> <sup>3)</sup> 2.40 J/cm <sup>2</sup> <sup>4)</sup> 0.30 J/cm <sup>2</sup> <sup>2)</sup> 0.55 J/cm <sup>2</sup> <sup>2)</sup>	42 fs, 1 kHz 70 fs, 10 Hz 150 fs, 1 kHz 1 ps, 1 kHz
High power mirror for ps pulses	> 99.9 %	0.35 J/cm <sup>2</sup> <sup>1)</sup> 0.44 J/cm <sup>2</sup> <sup>2)</sup> 0.65 J/cm <sup>2</sup> <sup>2)</sup>	50 fs, 1 kHz 150 fs, 1 kHz 1 ps, 1 kHz

1) Measurements were performed at Friedrich Schiller University Jena  
 2) Measurements were performed at Laser Zentrum Hannover  
 3) Measurements were performed at Wigner Research Centre for Physics, Budapest  
 4) Measurements were performed at Helmholtz-Zentrum Dresden-Rossendorf  
 \* A significant number of designs were tested. The LIDT values stated here are typical for the corresponding test conditions.  
 \*\* Self-focusing effects may destroy the substrate while the AR coating is still intact.

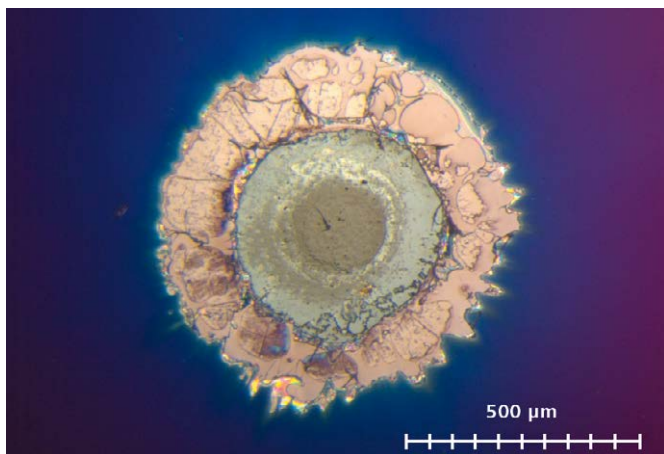


Figure 2: Laser-induced damage to a coated surface, diameter ≈ 750 μm

### Metallic High Power Mirrors

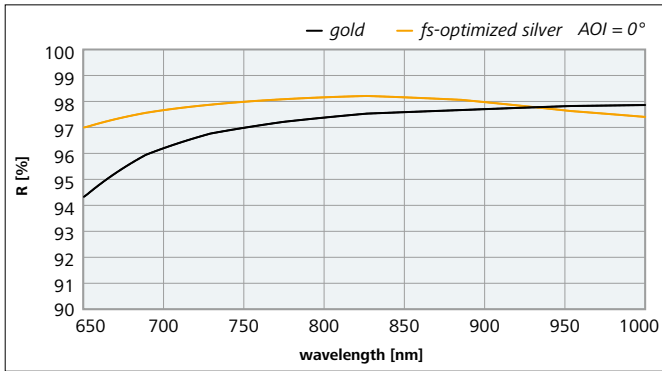


Figure 3: Reflectance spectra of unprotected gold and fs-optimized silver (optimized for high reflectance at 800 nm)

### GDD of High Power Ultrafast Laser Mirrors

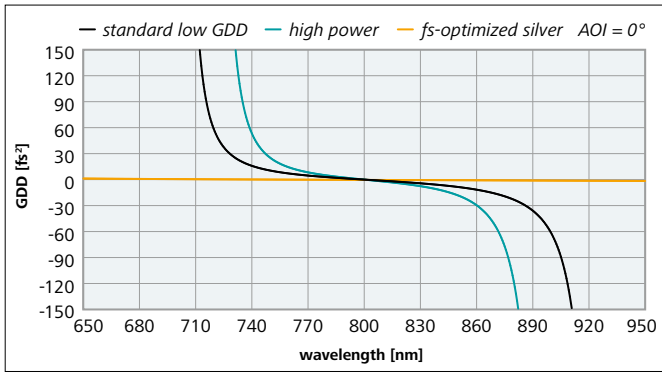


Figure 4: Group delay dispersion (GDD) of standard and high power dielectric mirrors and fs-optimized silver mirrors

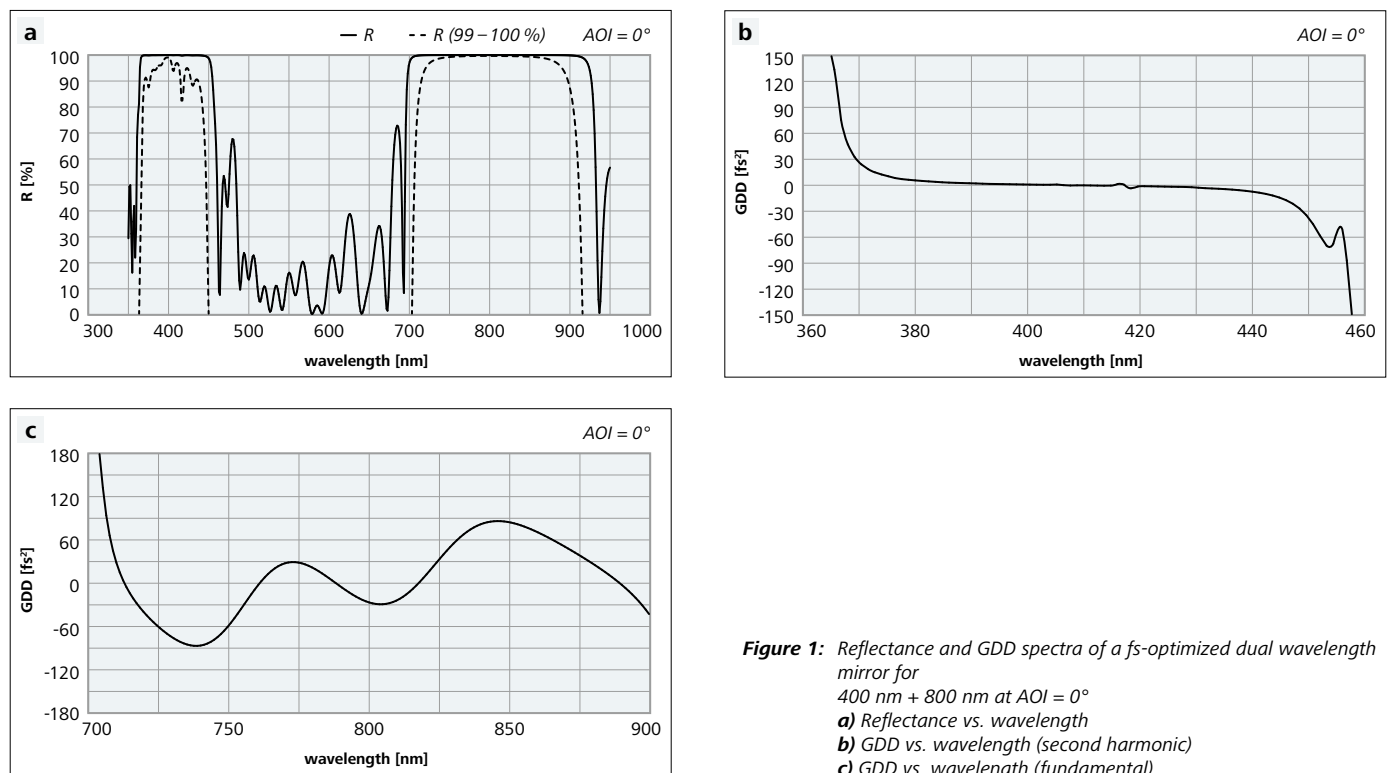
# Components for the Second Harmonic of the Ti:Sapphire Laser (300 – 600 nm)

## Dual Wavelength Mirrors for AOI = 0°

The second harmonic of the Ti:Sapphire laser provides fs-pulses in the NUV and VIS spectral range. This aspect offers a variety of applications in spectroscopy and materials science. Optics for these special applications must be optimized for both high reflectance and low dispersion. Negative dispersion mirrors for pulse compression are of interest as well.

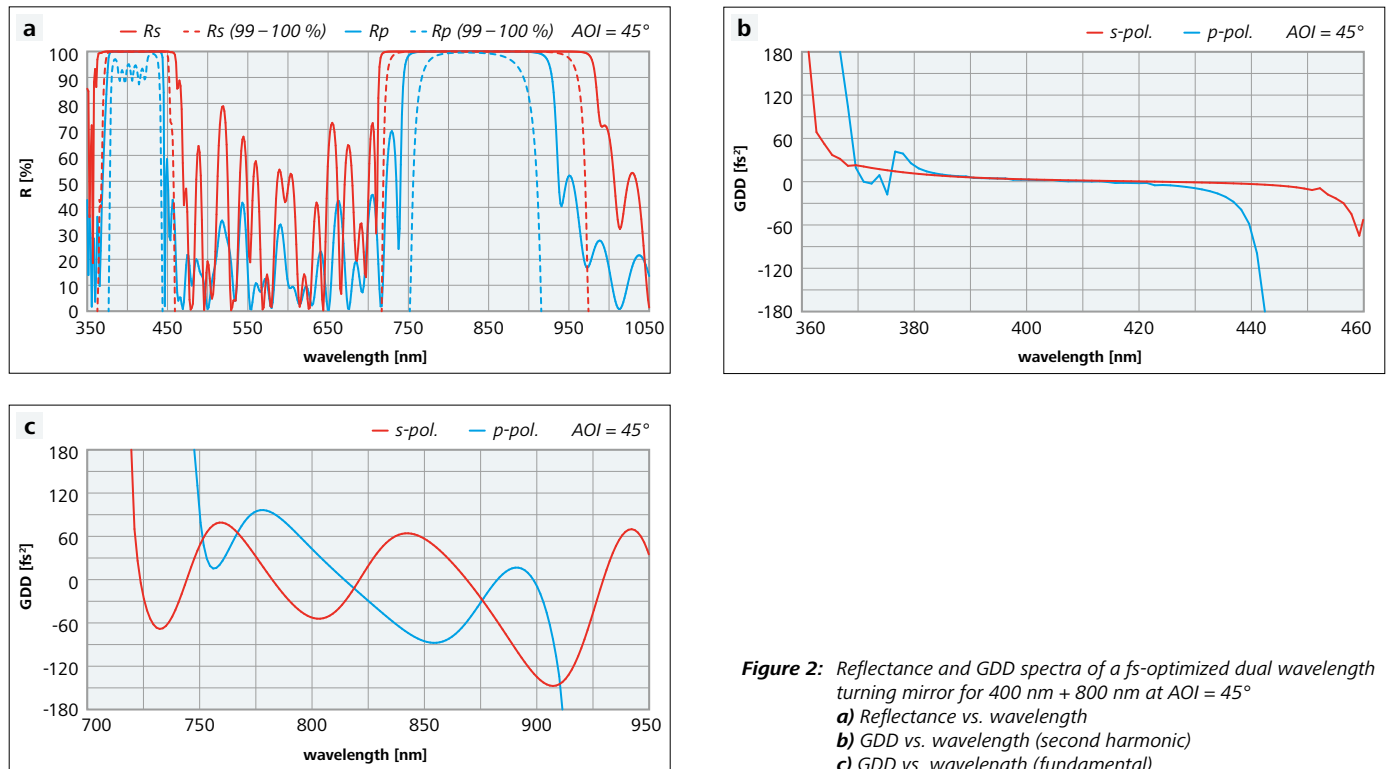
### Special Features

- High reflectance ( $R > 99.9\%$ )
- Center wavelength and bandwidth according to customer specifications
- Spectral tolerance  $\pm 1\%$
- Prototype production according to customer specifications
- In-house design calculation and measurement capabilities



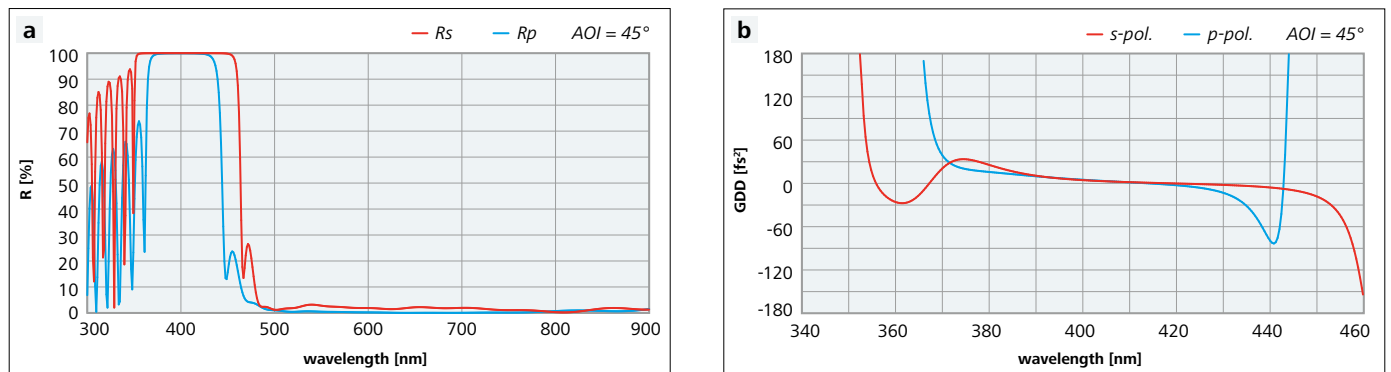
**Figure 1:** Reflectance and GDD spectra of a fs-optimized dual wavelength mirror for 400 nm + 800 nm at AOI = 0°  
**a)** Reflectance vs. wavelength  
**b)** GDD vs. wavelength (second harmonic)  
**c)** GDD vs. wavelength (fundamental)

Dual Wavelength Turning Mirrors for AOI = 45°



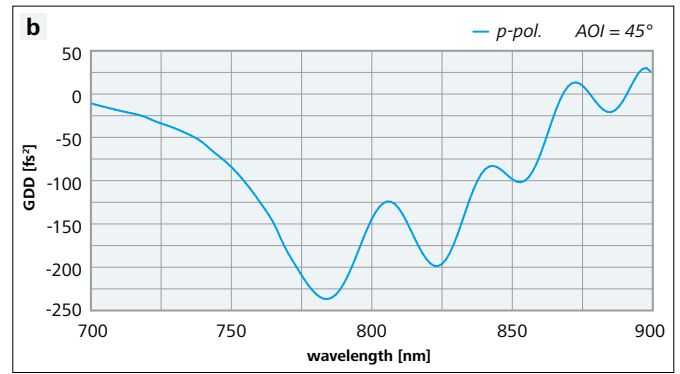
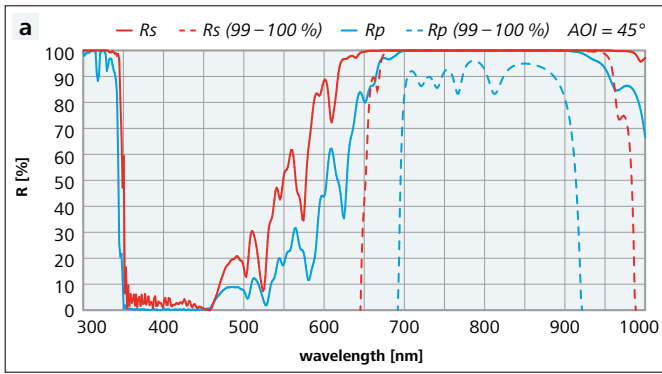
**Figure 2:** Reflectance and GDD spectra of a fs-optimized dual wavelength turning mirror for 400 nm + 800 nm at AOI = 45°  
**a)** Reflectance vs. wavelength  
**b)** GDD vs. wavelength (second harmonic)  
**c)** GDD vs. wavelength (fundamental)

Separators for the Second Harmonic from the Fundamental for AOI = 45°



**Figure 3:** Reflectance and GDD spectra of a separator  $HR_{s,p}(45^\circ, 400\text{ nm}) > 99.9\%$  +  $R_{s,p}(45^\circ, 800\text{ nm}) < 2\%$   
**a)** Reflectance vs. wavelength  
**b)** GDD vs. wavelength

- Reflectance  $R > 99.9\%$  for s- and p-polarization in the reflectance band
- Transmittance  $T > 95\%$  for s- and p-polarization in the transmittance band
- These components work for p- and s- polarization, but performance can be optimized if the polarization is clearly specified

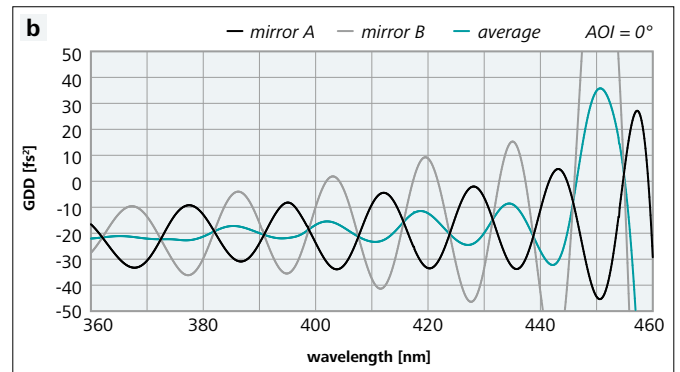
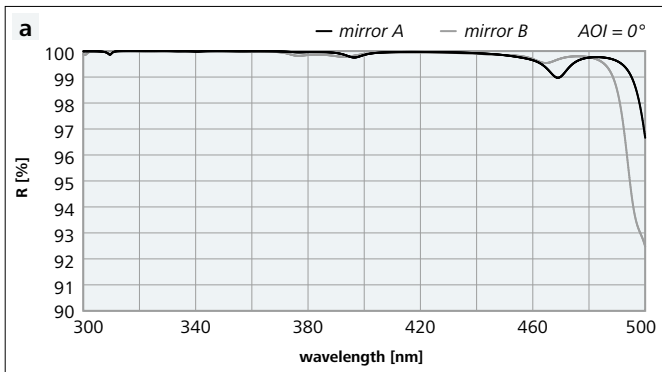


**Figure 4:** Reflectance and GDD spectra of a separator HRp (45°, 800 nm) > 99.9 % + Rp (45°, 400 nm) < 2 % + Rs (45°, 400 nm) < 10 %

- a) Reflectance vs. wavelength
- b) GDD vs. wavelength

- Bandwidth of the 800 nm reflectance band > 200 nm for p-polarization
- All separators exhibit |GDD| < 20 fs<sup>2</sup> in the transmittance band

Negative Dispersion Mirror Pair for the 400 nm Spectral Range at AOI = 0°

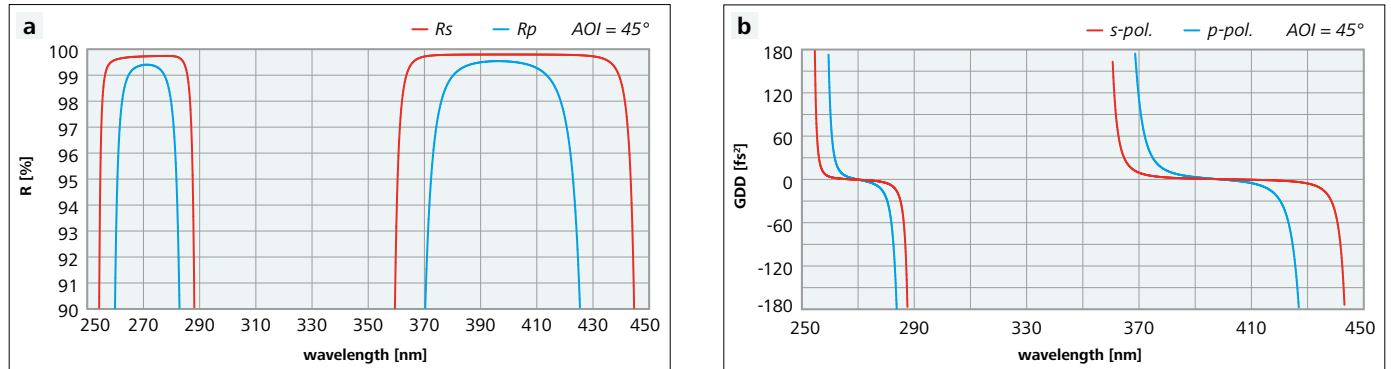


**Figure 5:** Reflectance and GDD spectra of a negative dispersion mirror pair for 350 – 480 nm with an average GDD varying from -30 fs<sup>2</sup> at 350 nm to 0 fs<sup>2</sup> at 480 nm (TOD optimized)

- a) Reflectance vs. wavelength
- b) GDD vs. wavelength

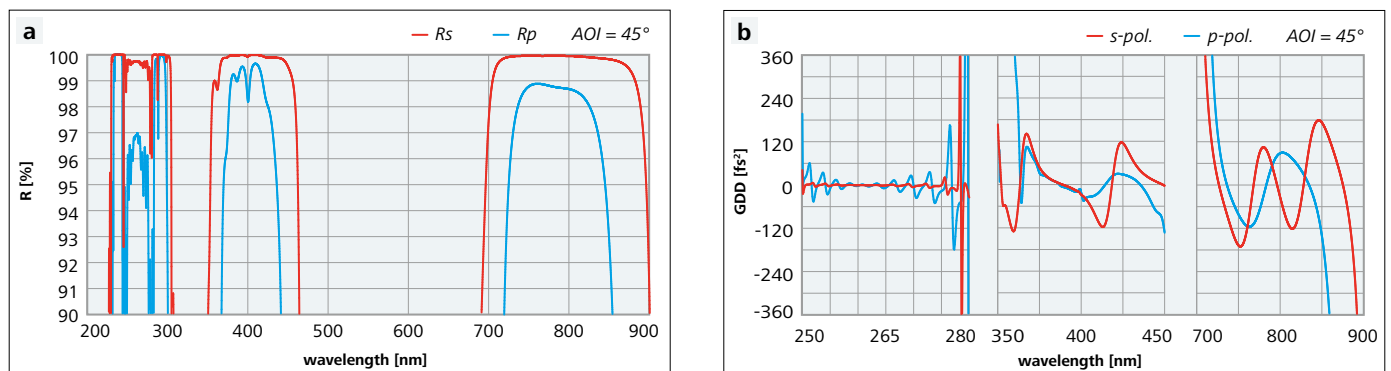
# Components for the Third Harmonic of the Ti:Sapphire Laser (250 – 400 nm)

## Dual Wavelength Turning Mirrors for AOI = 45°



**Figure 1:** Reflectance and GDD spectra of a fs-optimized dual wavelength turning mirror for 270 nm and 405 nm  
**a)** Reflectance vs. wavelength  
**b)** GDD vs. wavelength

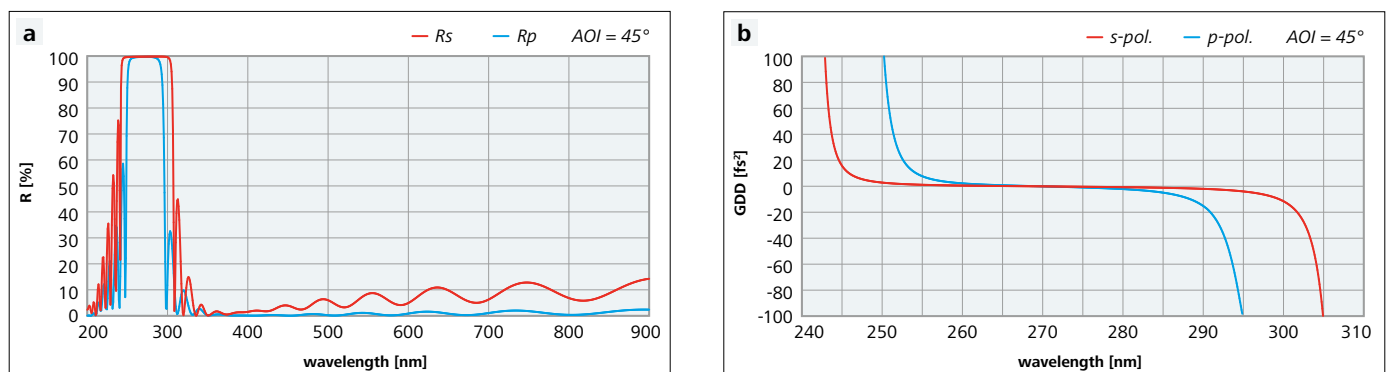
## Triple Wavelength Turning Mirrors for AOI = 45°



**Figure 2:** Reflectance and GDD spectra of a fs-optimized turning mirror for the 266 nm, 400 nm and 800 nm wavelength regions  
**a)** Reflectance vs. wavelength  
**b)** GDD vs. wavelength

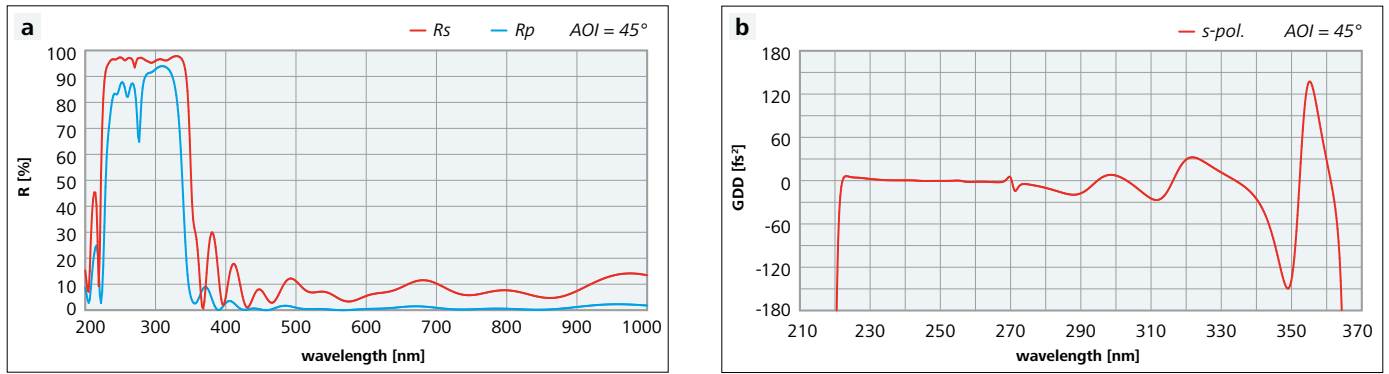
Please note that this triple wavelength turning mirror exhibits  $|GDD| < 50 \text{ fs}^2$  in all three wavelength regions of interest.

## Separators for the Third Harmonic from the Second Harmonic and the Fundamental Wave for AOI = 45°



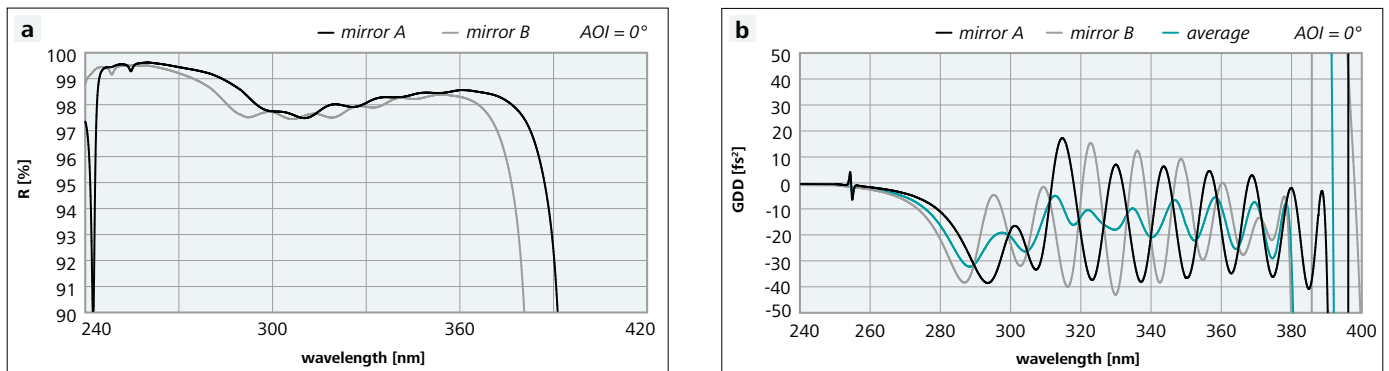
**Figure 3:** Reflectance and GDD spectra of a standard separator reflecting the third harmonic and transmitting the second harmonic and the fundamental  
**a)** Reflectance vs. wavelength  
**b)** GDD vs. wavelength

For the bandwidth of the reflectance and low-GDD ranges, please see table 1 on page 63.



**Figure 4:** Reflectance and GDD spectra of a broadband separator with high reflectance for s-polarized light throughout the wavelength range of the third harmonic of the Ti:Sapphire laser and high transmittance for p-polarized light in the VIS and NIR:  
 $HR_s(45^\circ, 250 - 330 \text{ nm}) > 95\% + Rp(45^\circ, 440 - 1000 \text{ nm}) < 3\%$   
**a)** Reflectance vs. wavelength  
**b)** GDD-Rs vs. wavelength

Negative Dispersion Mirror Pair for AOI = 0°

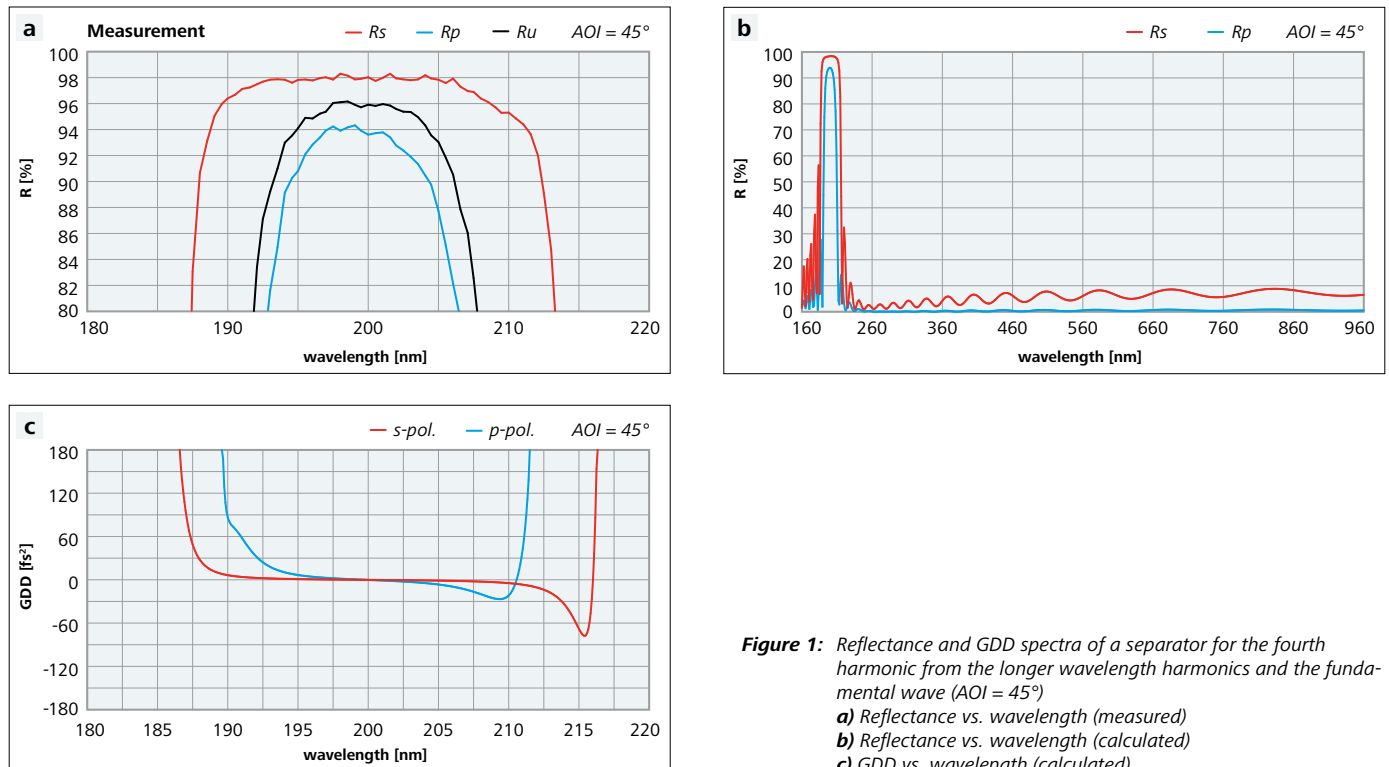


**Figure 5:** Reflectance and GDD spectra of a broadband negative dispersion mirror pair  
 $HR(0^\circ, 275 - 400 \text{ nm}) > 99\%$  with an average GDD of  $\approx -10 \text{ fs}^2$  per bounce  
**a)** Reflectance vs. wavelength  
**b)** GDD vs. wavelength

## Components for the Higher Harmonics of the Ti:Sapphire Laser (140 – 250 nm)

The fourth, fifth and sixth harmonics of the Ti:Sapphire laser provide fs-pulses in the DUV/VUV range. These harmonics offer a variety of applications in spectroscopy as well as in materials science. Optics for these very special applications must be optimized for high reflectance and low dispersion. Mirrors and separators for the wavelength range 125 – 215 nm consist of fluoride layer systems on CaF<sub>2</sub> substrates while components for longer wavelengths can be made of oxides. For mirrors, LAYERTEC recommends substrates with a thickness of 3 mm or 6.35 mm to achieve good flatness values. For special separators, LAYERTEC offers substrates of Fused Silica or calcium fluoride as thin as 1 mm or 0.5 mm.

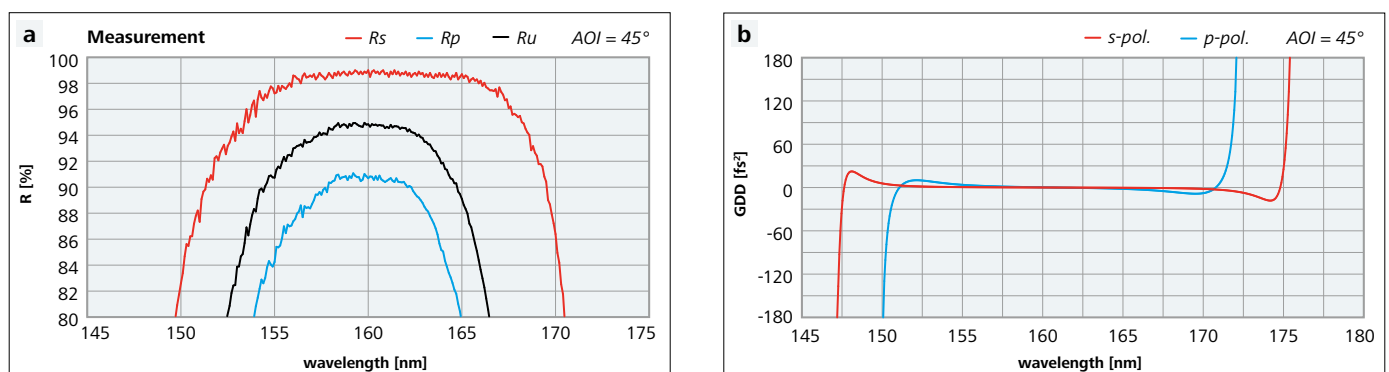
### Turning Mirrors and Separators for the Fourth Harmonic at AOI = 45°



**Figure 1:** Reflectance and GDD spectra of a separator for the fourth harmonic from the longer wavelength harmonics and the fundamental wave (AOI = 45°)

- a)** Reflectance vs. wavelength (measured)
- b)** Reflectance vs. wavelength (calculated)
- c)** GDD vs. wavelength (calculated)

### Components for the Fifth Harmonic at AOI = 45°

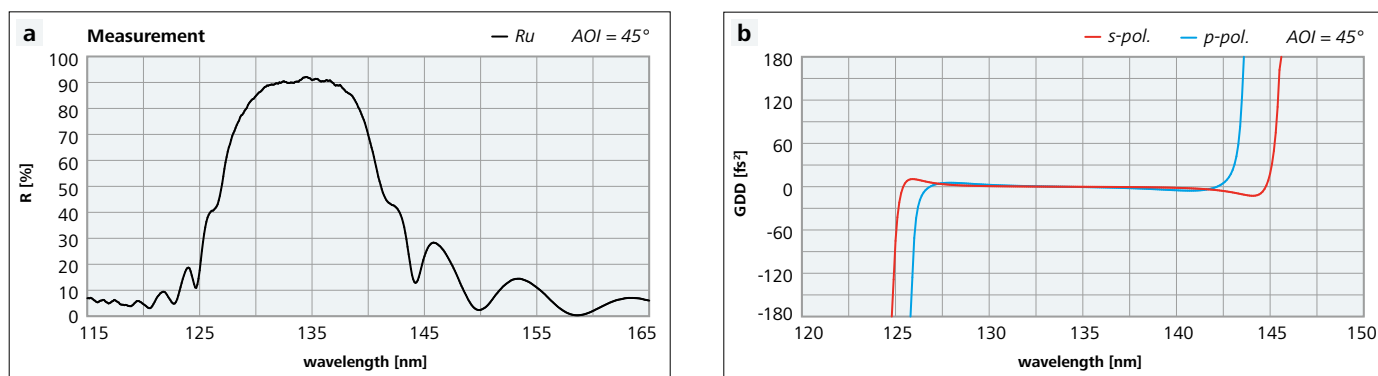


**Figure 2:** Reflectance and GDD spectra of a turning mirror for 160 nm (AOI = 45°)

- a)** Reflectance vs. wavelength (measured)
- b)** GDD vs. wavelength (calculated)



Components for the Sixth Harmonic at AOI = 45°



**Figure 3:** Reflectance and GDD spectra of a turning mirror for 133 nm (AOI = 45°)  
**a)** Reflectance vs. wavelength (measured for unpolarized light)  
**b)** GDD vs. wavelength (calculated)

Bandwidth of the Reflectance and Low-GDD Range of Standard Components

- The coatings described on page 60 ff. can be used to achieve center wavelengths as given in the following table. Different coating materials are used for different wavelength ranges
- All coatings are optimized for broad reflection bands, high reflectance and low GDD

**Table 1:** Bandwidth of the reflectance and low-GDD range of standard components

Component	Wavelength Range	P-Polarization ( $ \text{GDD}  < 20 \text{ fs}^2$ )	S-Polarization ( $ \text{GDD}  < 20 \text{ fs}^2$ )
Turning mirror or separator 3 <sup>rd</sup> harmonic	250 nm – 330 nm	30 nm (R > 99 %)	50 nm (R > 99 %)
Dual wavelength turning mirror	250 nm – 330 nm	15 nm (R > 99 %)	26 nm (R > 99 %)
	370 nm – 500 nm	34 nm (R > 99 %)	72 nm (R > 99 %)
Turning mirror or separator 4 <sup>th</sup> harmonic	180 nm – 250 nm	5 nm (R > 93 %)	15 nm (R > 97 %)
Turning mirror or separator 5 <sup>th</sup> harmonic	140 nm – 180 nm	4 nm (R > 90 %)	12 nm (R > 97 %)
Turning mirror or separator 6 <sup>th</sup> harmonic	125 nm – 140 nm	8 nm (R > 85 % unpolarized)	

## Gires-Tournois-Interferometer (GTI) Mirrors (600 – 1600 nm)

Gires-Tournois-Interferometer (GTI) mirrors are used for pulse compression in short pulse lasers such as Yb:YAG- or Yb:KGW-lasers. LAYERTEC also offers GTI mirrors for the Ti:Sapphire wavelength range and for other ultrafast lasers in the NIR spectral range. Compared to prism compressors, GTI mirrors reduce the intra cavity losses resulting in higher output power of the laser.

### Special Features

- Very high reflectance
- Center wavelength, bandwidth and GDD according to customer specifications
- Please note that bandwidth and GDD are closely connected. A high value of negative GDD results in a very narrow bandwidth
- Spectral tolerance  $\pm 1\%$
- In-house design calculation and measurement capabilities (GDD 250 – 1700 nm, reflectance measurement by CRD 210 – 1800 nm)

Table 1: LIDT Info

LIDT	Wavelength	Pulse Duration	Repetition Rate	Pulses at each Site	Beam Diameter	Measurements at
$\approx 0.1 \text{ J/cm}^2$	800 nm	150 fs				Laser Zentrum Hannover
$\approx 225 \text{ mJ/cm}^2$	1030 nm	44 fs	1 KHz	100 000-on-1	$1/e^2 \approx 750 \mu\text{m}$	DESY Hamburg 2021

### GTI-Mirrors for Yb:YAG and Yb:KGW-Lasers

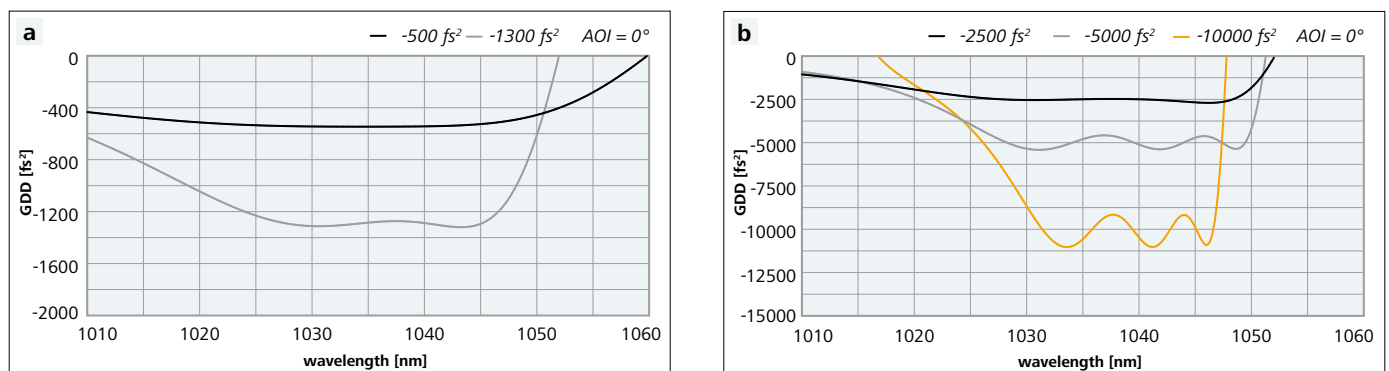


Figure 1: GDD spectra of GTI-mirrors for 1040 nm with different GDD values

a)  $-500 \text{ fs}^2$ ,  $-1300 \text{ fs}^2$

b)  $-2500 \text{ fs}^2$ ,  $-5000 \text{ fs}^2$ ,  $-10\,000 \text{ fs}^2$

- Typical reflectance values depending on dispersion:
  - 500  $\text{fs}^2$ :  $R \geq 99.99\%$
  - 1300  $\text{fs}^2$ :  $R \geq 99.98\%$
  - 2500  $\text{fs}^2$ :  $R \geq 99.97\%$
  - 5000  $\text{fs}^2$ :  $R \geq 99.95\%$
  - 10 000  $\text{fs}^2$ :  $R \geq 99.95\%$

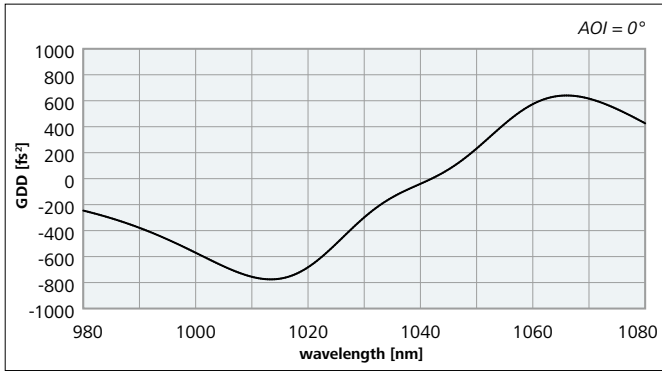


Figure 2: GTI mirror with nearly constant TOD

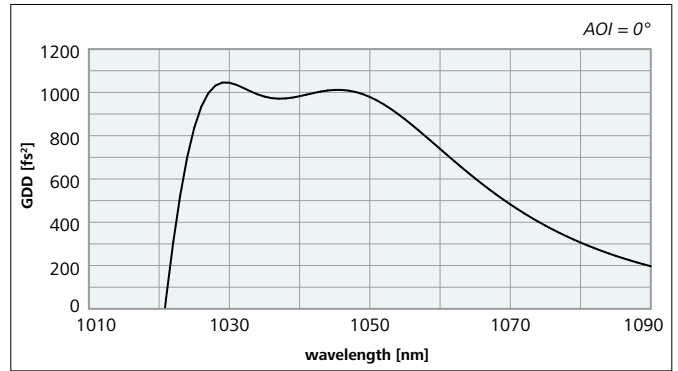


Figure 3: GTI mirror with positive GDD

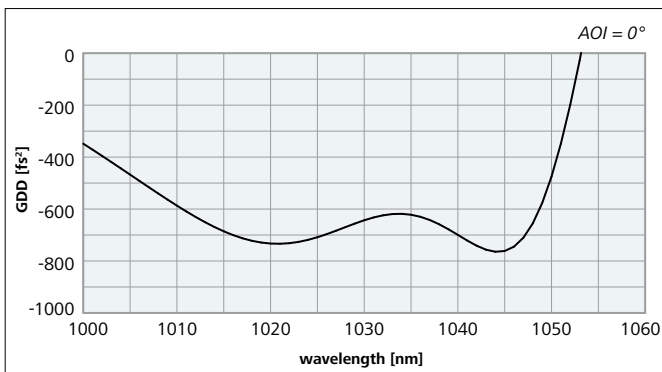


Figure 4: GDD spectrum of a rear side GTI mirror with  $GDD(0^\circ - 10^\circ, 1030 \text{ nm}) \approx -700 \text{ fs}^2$

The mirror is irradiated through the substrate which has an AR coating on the front side. Rear side GTI mirrors are insensitive against surface contaminations which sometimes distort the GDD spectrum of common front side GTI mirrors.

### Optical Losses of GTI-Mirrors

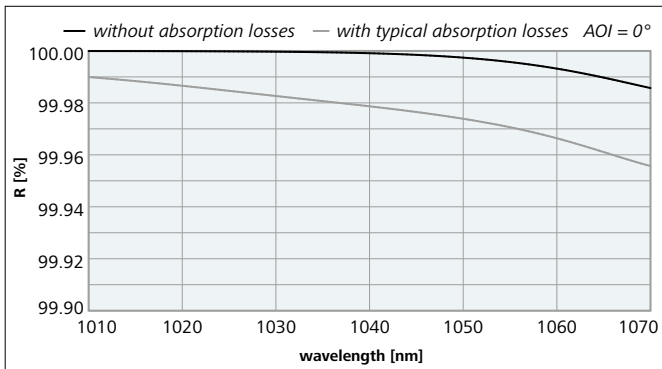


Figure 5: Calculated reflectance spectra of a GTI mirror without absorption losses (black) and with typical absorption losses (grey)

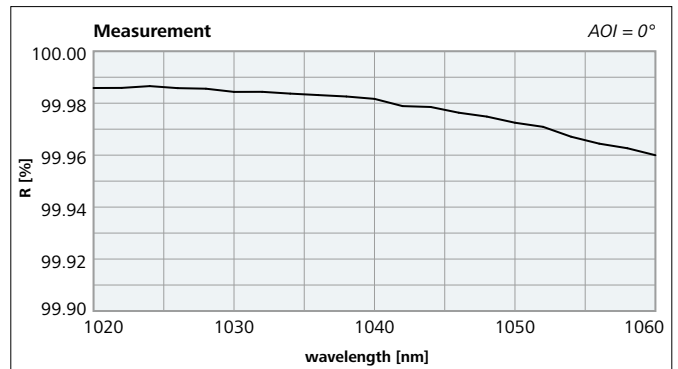


Figure 6: Measured reflectance spectrum of a GTI mirror (design as calculated in figure 5)

GTI mirrors of LAYERTEC show high reflectance values (e.g.  $R > 99.98\%$  at 1030 nm). The reflectance can be measured exactly by CRD. The high reflectance proves that the absorption losses in the GTI mirrors are very small. This also results in very small thermal lensing inside these GTI mirrors if they are used in high power lasers.

Coating Homogeneity and Reproducibility of GTI-Mirrors

Figure 8 and figure 9 show that all GTI mirrors which were produced in these batches meet the specifications given in figure 7. Comparing mirrors from two batches the variation within a batch and between batches are much smaller than what is allowed by the specifications. The excellent reproduction of complex coating designs is the basis for the use of GTI mirrors in industrial short pulse lasers.

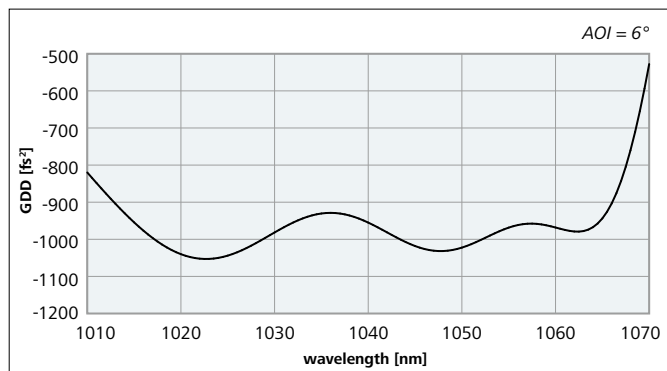


Figure 7: Calculated GDD spectrum of a GTI mirror:  $GDD-R(6^\circ, 1020 - 1060 \text{ nm}) \approx -1000 \pm 200 \text{ fs}^2$

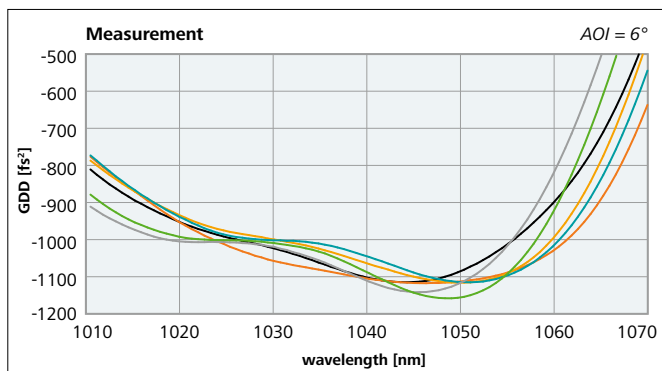


Figure 8: Measured GDD spectra of 6 GTI mirrors which were coated in the same batch according to the design of figure 7

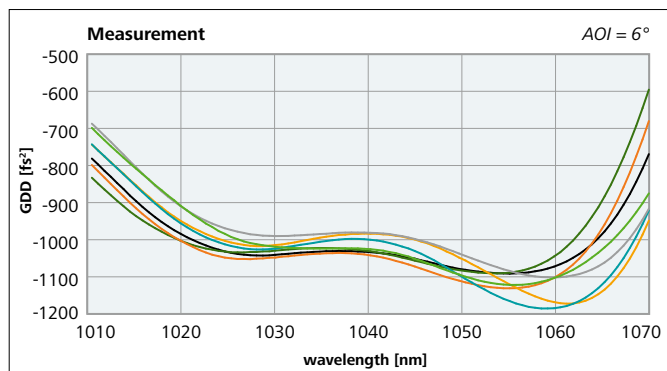


Figure 9: Measured GDD spectra of 6 GTI mirrors which were coated in a second batch according to the design of figure 7

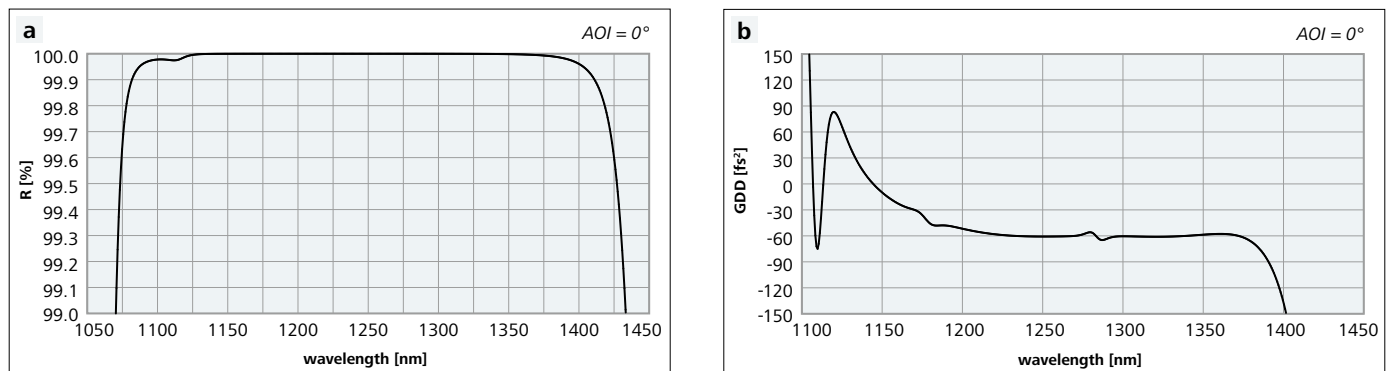
# Optics for Ultrafast Lasers in the Wavelength Range of 1000 – 1600 nm

Although Ti:Sapphire lasers are currently the most important ultrafast lasers, many applications require ultrafast pulses at considerably longer wavelengths. Several lasers emitting light between 1100 nm and 1600 nm have been developed, such as the Cr:Forsterite laser (1150 – 1350 nm) or the Er:Fiber laser (1550 nm). Some examples of coatings such as negative dispersion mirrors and mirror pairs for these wavelength ranges are presented.

## Special Features

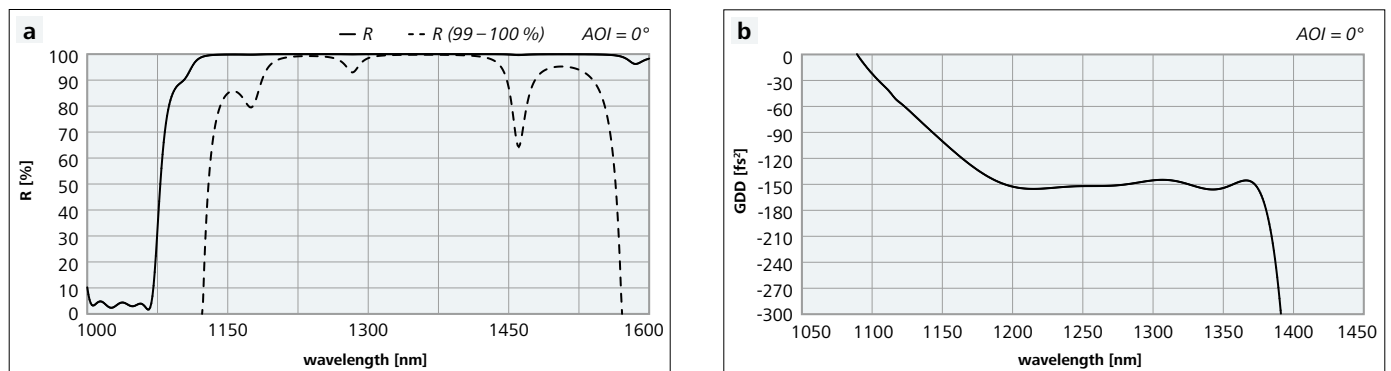
- Very high reflectance of the mirrors ( $R > 99.8\%$  ...  $R > 99.99\%$  depending on the design)
- Center wavelength, bandwidth, GDD and TOD according to customer specifications
- Spectral tolerance  $\pm 1\%$
- In-house design calculation and measurement capabilities (GDD 250 – 1700 nm, reflectance 210 – 1800 nm)

### Negative Dispersion Laser and Pump Mirrors for AOI = 0°



**Figure 1:** Reflectance and GDD spectra of a negative dispersion laser mirror ( $GDD \approx -60 \text{ fs}^2$  for 1200 – 1370 nm)

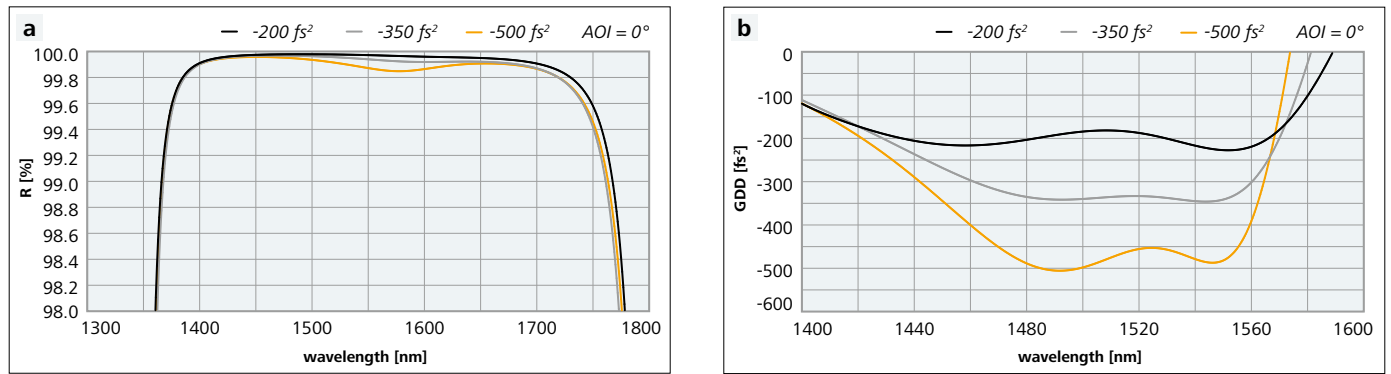
- a)** Reflectance vs. wavelength  
**b)** GDD vs. wavelength



**Figure 2:** Reflectance and GDD spectra of a negative dispersion pump mirror:  
 $HR(0^\circ, 1180 - 1380 \text{ nm}) > 99.8\%$  +  $R(0^\circ, 1020 - 1070 \text{ nm}) < 5\%$ ,  
 $GDD-R(0^\circ, 1180 - 1380 \text{ nm}) \approx -150 \text{ fs}^2$

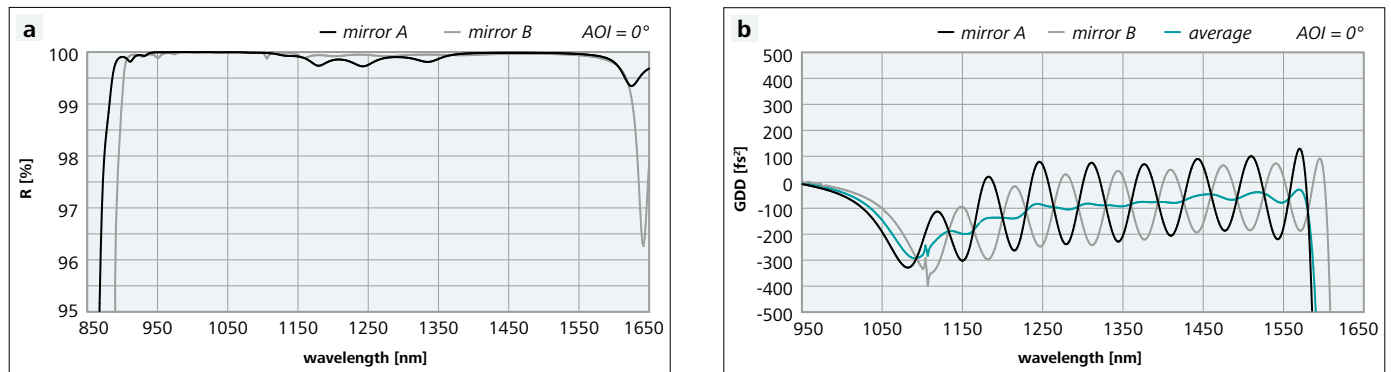
- a)** Reflectance vs. wavelength  
**b)** GDD vs. wavelength

**GTI-Mirrors for AOI = 0°**



**Figure 3:** Reflectance and GDD spectra of GTI mirrors for 1500 nm with different GDD values  
**a)** Reflectance vs. wavelength  
**b)** GDD vs. wavelength

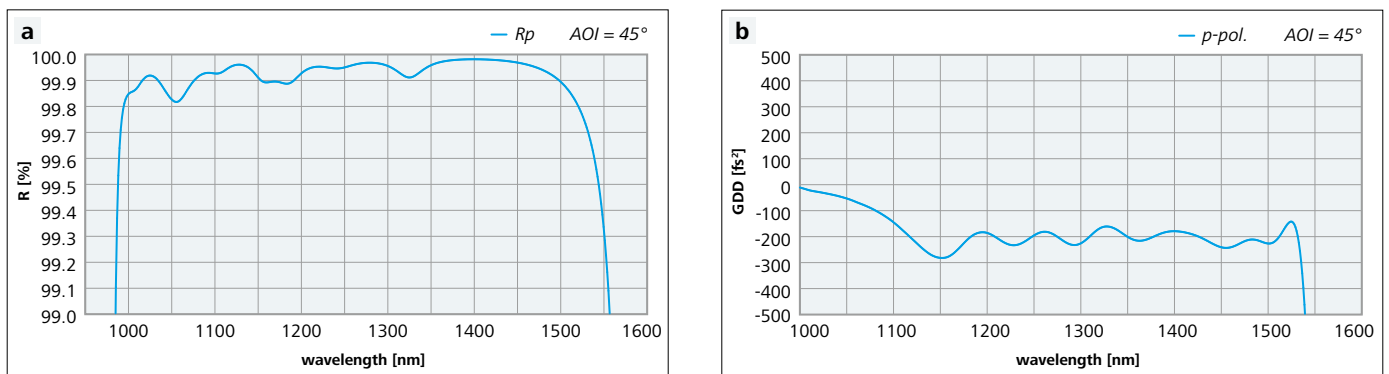
**Broadband Negative Dispersion Mirror Pairs for AOI = 0°**



**Figure 4:** Reflectance and GDD spectra of a broadband negative dispersion mirror pair; single mirrors with  $R > 99.7\%$  (mirror A) and  $R > 99.85\%$  (mirror B)  
**a)** Reflectance vs. wavelength  
**b)** GDD vs. wavelength

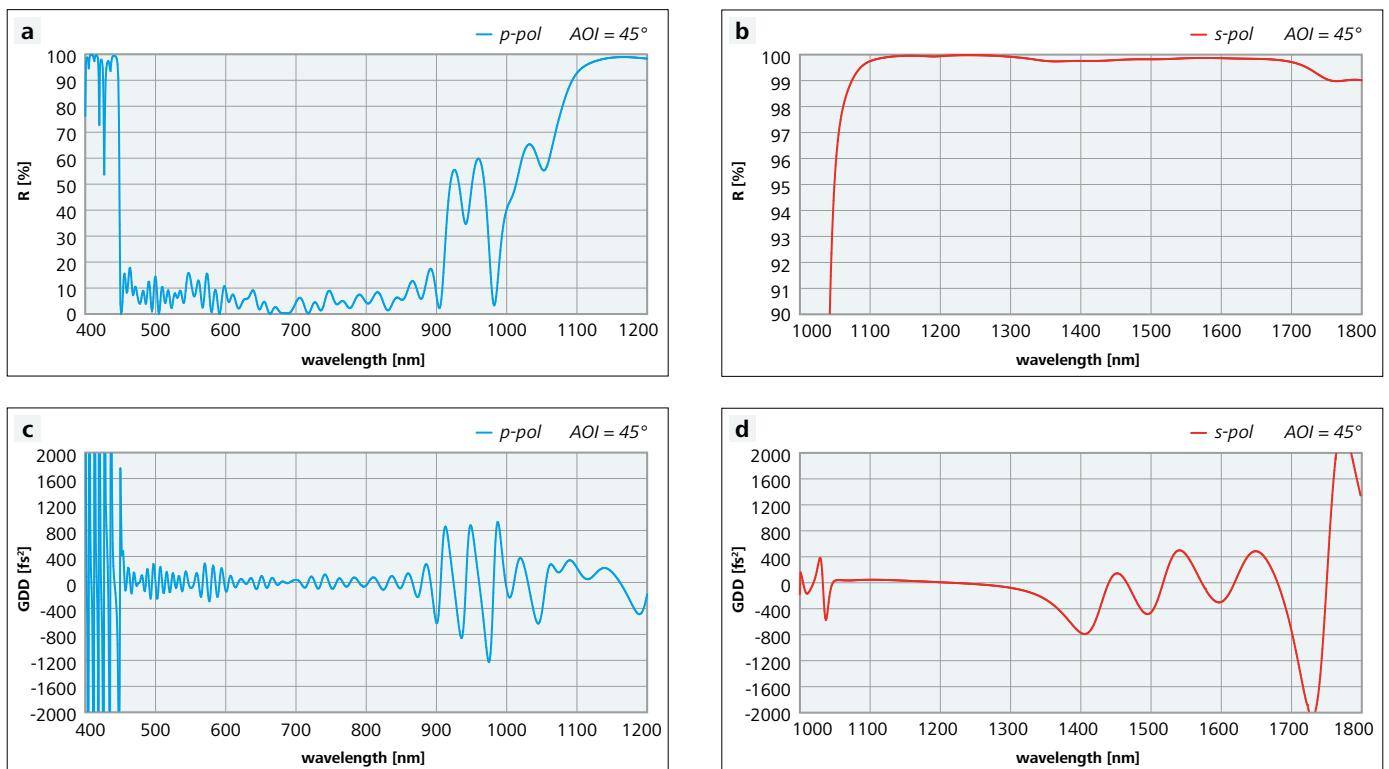
Specially designed mirror pairs show a very smooth average GDD spectrum, although the single broadband mirrors exhibit strong GDD oscillations. Pump mirror pairs (i.e. mirror pairs with one mirror showing high transmittance at the pump wavelength of the respective laser type) are also available.

**Broadband Negative Dispersion Turning Mirrors for AOI = 45°**



**Figure 5:** Reflectance and GDD spectra of a broadband negative dispersion mirrors  
**a)** Reflectance vs. wavelength  
**b)** GDD vs. wavelength

Please note the large bandwidth of this mirror. In contrast, low dispersion turning mirrors are available with bandwidths of about 200 nm for p-polarization and about 400 nm for s-polarization in this wavelength range.



**Figure 6:** Reflectance and GDD spectra of a beam combiner:  
 $HRs (45^\circ, 1100 - 1700 \text{ nm}) > 99.5\% + Rp (45^\circ, 450 - 900 \text{ nm}) < 15\%$  (average  $Rp < 10\%$ )  
 $|GDD-Rs (45^\circ, 1100 - 1700 \text{ nm})| < 750 \text{ fs}^2 + |GDD-Tp (45^\circ, 450 - 950 \text{ nm})| < 300 \text{ fs}^2$   
**a)** Reflectance p-pol. vs. wavelength  
**b)** Reflectance s-pol. vs. wavelength  
**c)** GDD-Tp (45°) vs. wavelength  
**d)** GDD-Rs (45°) vs. wavelength

# Selected Special Components

## Chapter Index

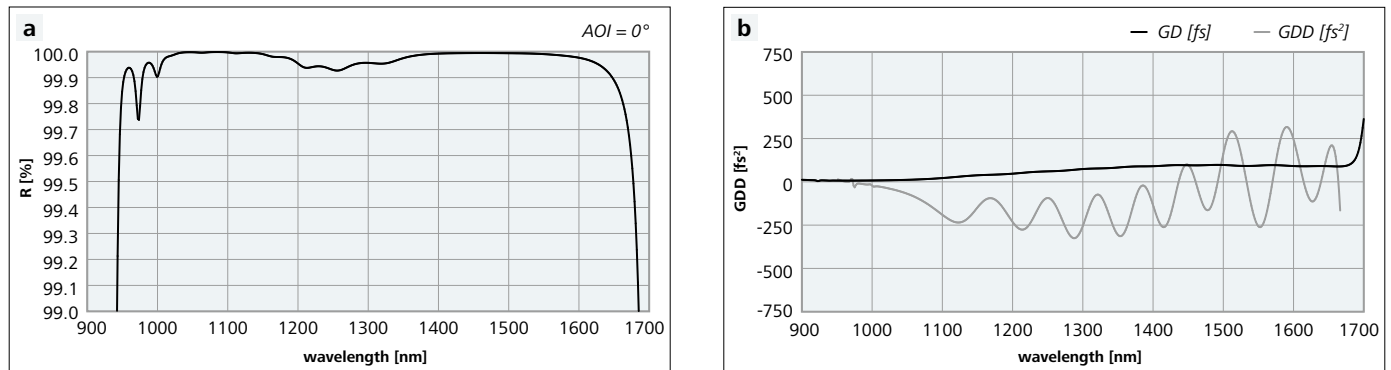
<b>Components for Optical Parametric Oscillators (OPO) .....</b>	<b>71</b>
Cavity Mirrors for AOI = 0° .....	71
Pump Mirrors and Separators for AOI = 0° .....	71
Output Couplers.....	72
Beam Splitters for AOI = 45° .....	73
Special Output Couplers for AOI = 0° .....	73
Turning Mirrors and Separators for AOI = 45° .....	73
Ultra Broadband Components for AOI = 45° .....	74
Edge Filters for AOI = 45° .....	75
Coatings on Nonlinear Optical Crystals AOI = 0° .....	75
<b>Broadband and Scanning Mirrors (300 – 2500 nm) .....</b>	<b>76</b>
Broadband Mirrors .....	76
Scanning Mirrors .....	77
<b>Filters for Laser Applications (260 – 2500 nm) .....</b>	<b>78</b>
Calibration Filters (300 – 5000 nm).....	78
Spectral Graduated Filters (300 – 4000 nm).....	78
Steep Edge Filters .....	78
Narrowband Reflectance Filters .....	79
Dual Wavelength Filters with Broad Blocking Range .....	79
<b>Thin Film Polarizers .....</b>	<b>80</b>
Standard Thin Film Polarizers .....	81
Special Thin Film Polarizers .....	81
<b>Low Loss Optical Components (340 – 3000 nm).....</b>	<b>82</b>
HR Mirrors.....	82
<b>Coatings on Crystal Optics (340 – 3000 nm).....</b>	<b>84</b>
Coatings on Doped Laser Crystals.....	85
Coatings on Nonlinear Optical Crystals .....	85



# Components for Optical Parametric Oscillators (OPO)

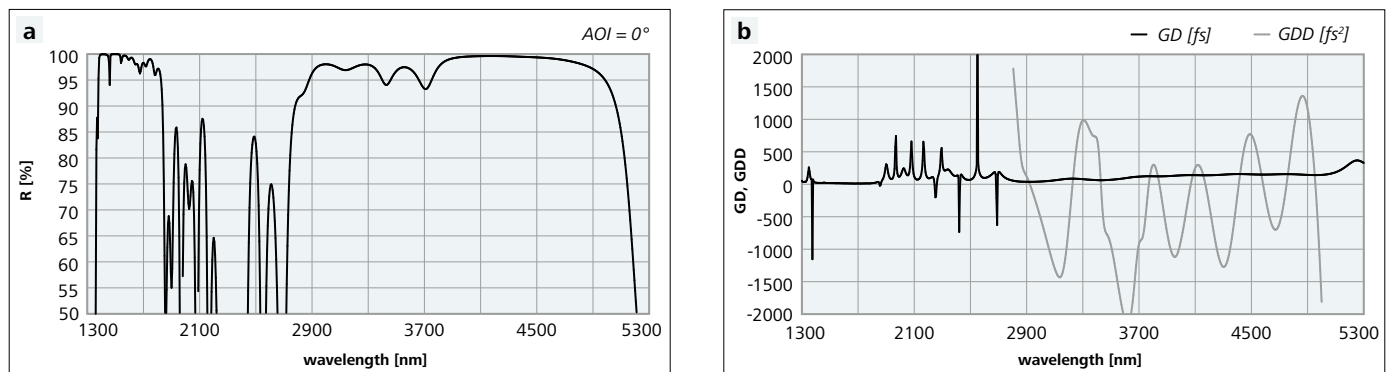
Mirrors for OPOs are optimized for separation of the pump laser, signal and idler wavelengths. This application requires a broad reflectance band for the signal wavelength and a wide range of high transmittance for the idler and pump wavelengths. Moreover, most of the optics show smooth group delay (GD) and group delay dispersion (GDD) spectra. Thus, wide tuning ranges for the signal and the idler wavelengths can be achieved. This enables the operation of OPOs with fs-pulses. Broadband output couplers are also available. Center wavelength and tuning range can be adjusted according to customer specifications. All OPO coatings are produced by magnetron sputtering. This process guarantees that the optical parameters are environmentally stable, because the coatings are compact, free of water and adhere strongly to the substrate in spite of the extreme coating thickness of 20 – 30  $\mu\text{m}$ . This makes sputtered OPO coatings ideal for application in harsh environments.

## Cavity Mirrors for AOI = 0°



**Figure 1:** Reflectance, GD and GDD spectra of a broadband HR mirror for the signal wavelength: HR (0°, 1000 – 1600 nm) > 99.9 %

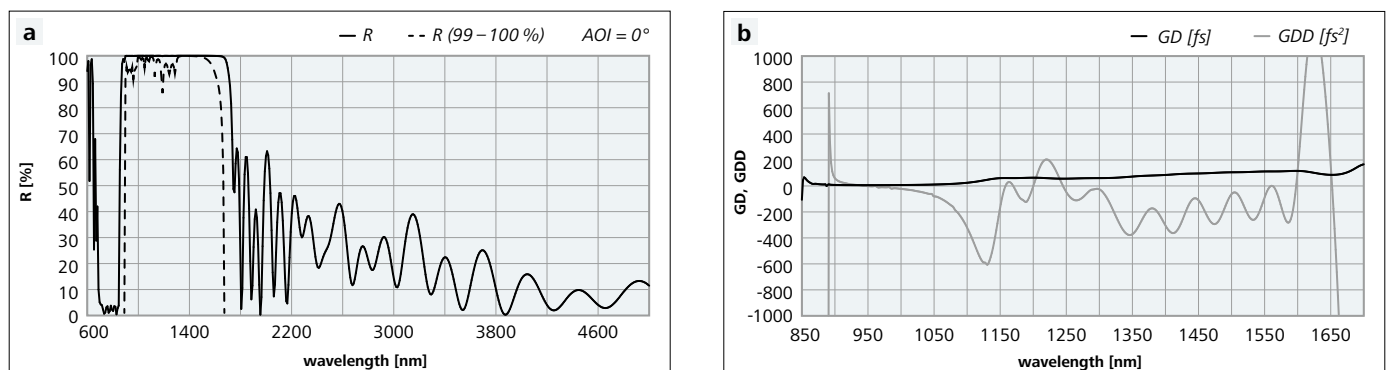
- a) Reflectance vs. wavelength
- b) GDD vs. wavelength



**Figure 2:** Reflectance, GD and GDD spectra of a dual HR mirror for the signal and idler wavelengths: HR (0°, 1400 – 1800 nm) > 96 % + HR (0°, 2900 – 4900 nm) > 93 %

- a) Reflectance vs. wavelength
- b) GD and GDD vs. wavelength

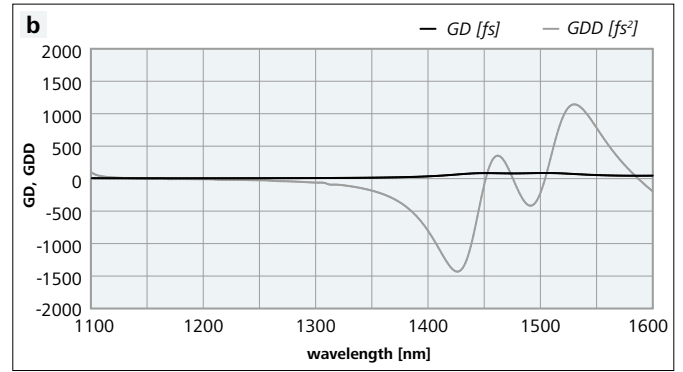
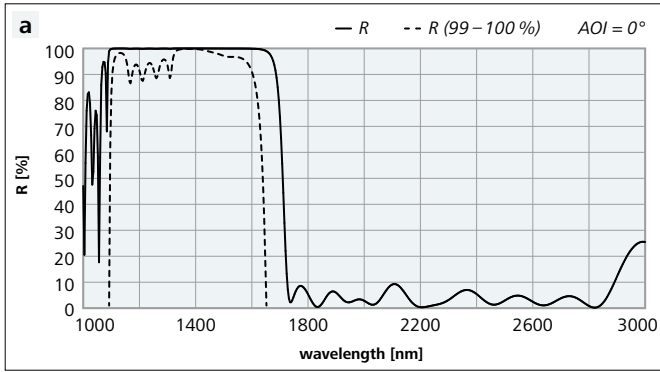
## Pump Mirrors and Separators for AOI = 0°



**Figure 3:** Reflectance, GD and GDD spectra of an OPO pump mirror

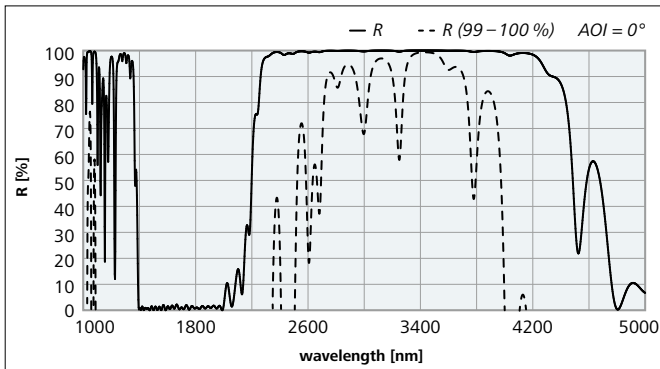
- a) Reflectance vs. wavelength
- b) GD and GDD vs. wavelength

This type of mirror separates the pump and signal wavelengths while suppressing the idler wavelength:  
 $R(0^\circ, 700 - 850 \text{ nm}) < 10\% + R(0^\circ, 900 - 1600 \text{ nm}) > 99.8\% + R(0^\circ, 1800 - 5000 \text{ nm}) < 60\%$ .

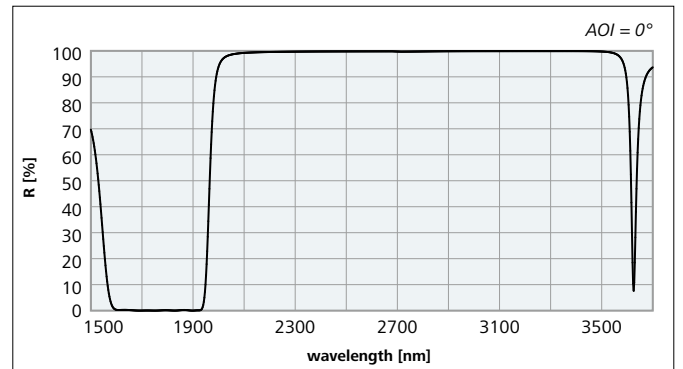


**Figure 4:** Reflectance, GD and GDD spectra of a separator for the signal and idler wavelengths  
**a)** Reflectance vs. wavelength  
**b)** GD and GDD vs. wavelength

- Edge filters separating signal and idler wavelengths can be used as broadband out-coupling mirrors for the idler:  $HR(0^\circ, 1100 - 1600 \text{ nm}) > 99.8\% + R(0^\circ, 1730 - 2900 \text{ nm}) < 10\%$
- These filters can also be provided with a band of high reflectance or high transmittance for the pump wavelengths or for the second harmonic of the signal wavelengths
- LAYERTEC recommends undoped YAG or sapphire as substrate material if high transmittance for the idler wavelengths is required (see also page 138 f. for transmittance curves)

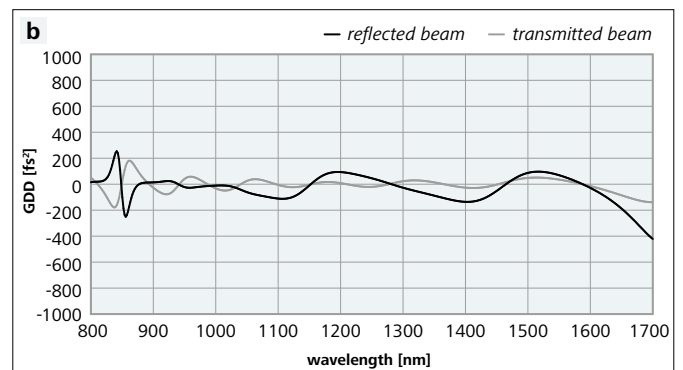
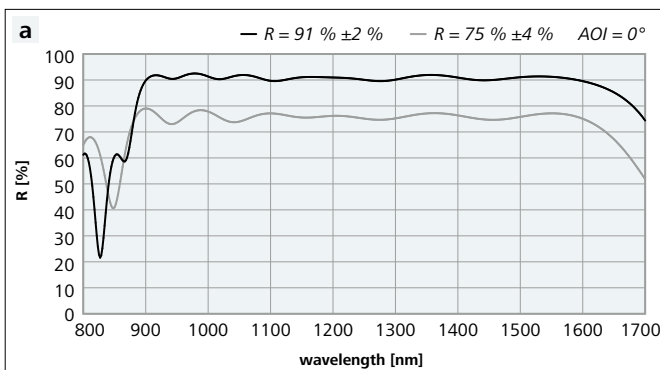


**Figure 5:** Reflectance spectrum of a broadband mirror for the NIR:  
 $HR(0^\circ, 2300 - 4000 \text{ nm}) > 99\%$



**Figure 6:** Reflectance spectrum of a separator for the signal and idler wavelengths:  
 $HR(0^\circ, 2050 - 3500 \text{ nm}) > 99\% + R(0^\circ, 1600 - 1930 \text{ nm}) < 5\%$

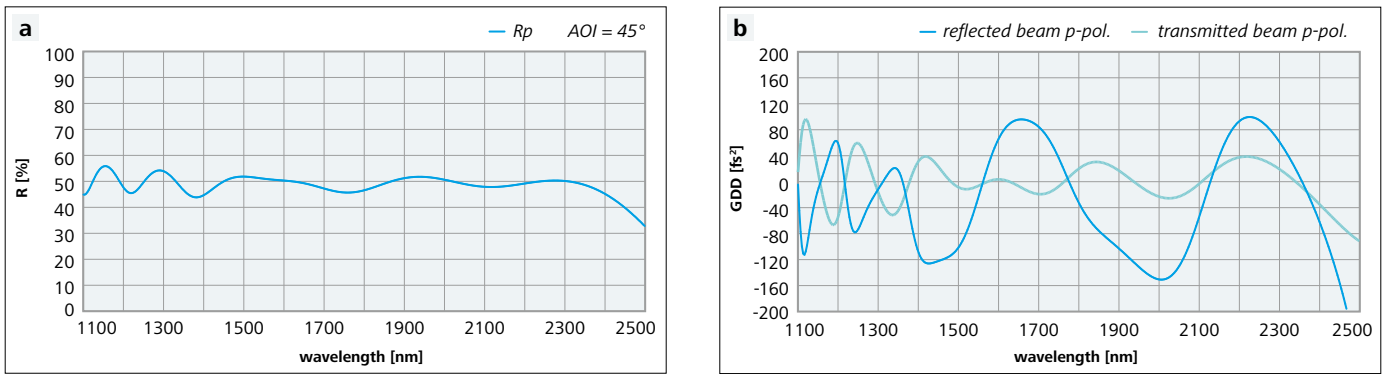
## Output Couplers



**Figure 7:** Reflectance and GDD spectra of different broadband output couplers for the signal wavelength range.  
**a)** Reflectance vs. wavelength  
**b)** GDD vs. wavelength (The spectra shown are calculated for the 75 % output coupler, but the spectra for other reflectance values are very similar.)

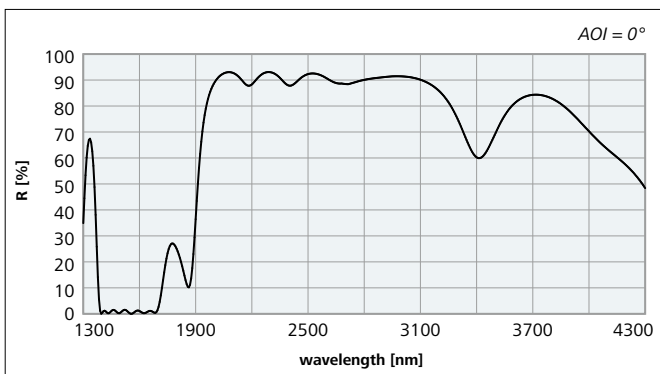
The reflectance of output couplers and beam splitters can be adjusted according to customer specifications.

Beam Splitters for AOI = 45°

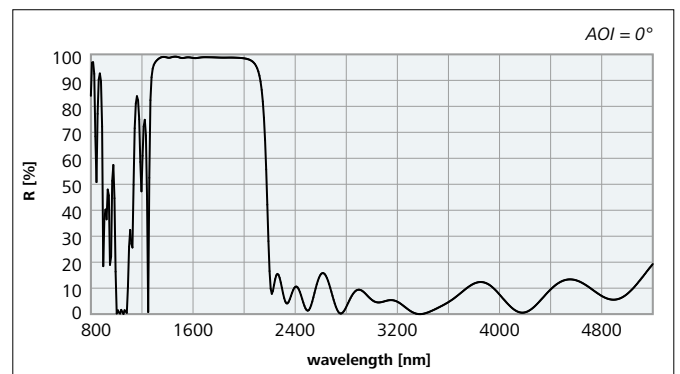


**Figure 8:** Reflectance and GDD spectra of a broadband beam splitter for p-polarized signal and idler radiation:  $PR_p(45^\circ, 1100 - 2400 \text{ nm}) = 50 \% \pm 5 \%$   
**a)** Reflectance vs. wavelength  
**b)** GDD vs. wavelength

Special Output Couplers for AOI = 0°



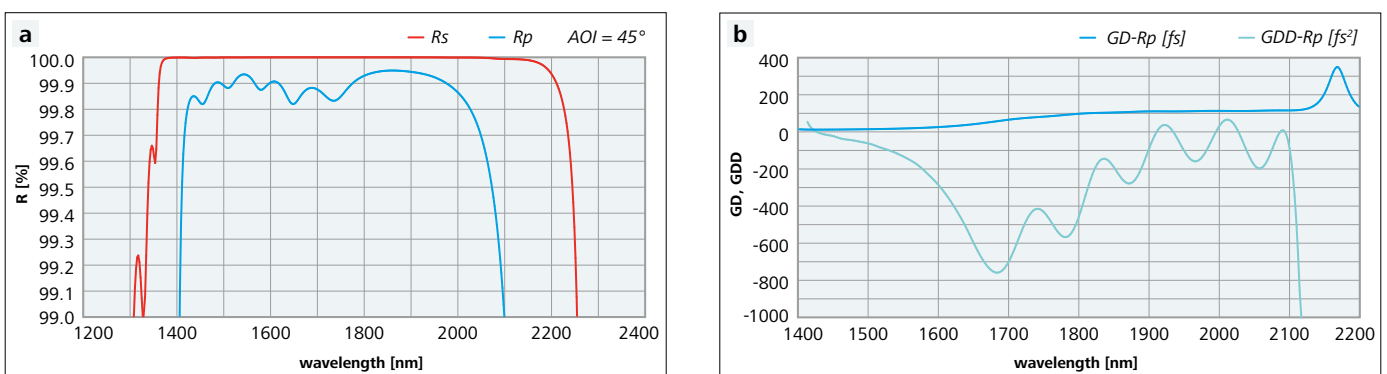
**Figure 9:** Reflectance spectrum of a special output coupler:  
 $PR(0^\circ, 2000 - 3150 \text{ nm}) = 90 \% \pm 3 \%$   
 $+ R(0^\circ, 1400 - 1700 \text{ nm}) < 3 \%$



**Figure 10:** Reflectance spectrum of a special output coupler:  
 $PR(0^\circ, 1350 - 2000 \text{ nm}) = 98 \% \pm 0.5 \%$   
 $+ R(0^\circ, 1000 - 1100 \text{ nm}) < 3 \%$   
 $+ R(0^\circ, 2200 - 5000 \text{ nm}) < 20 \%$

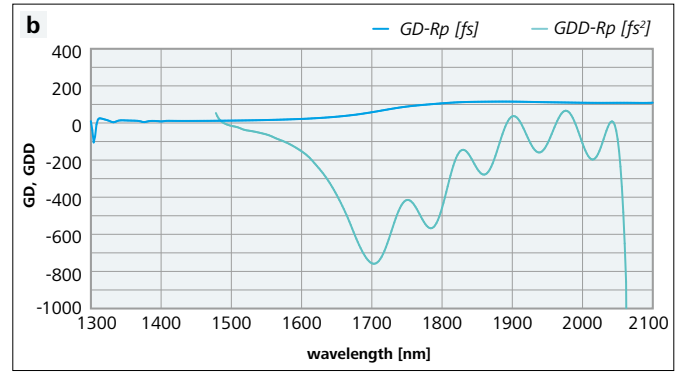
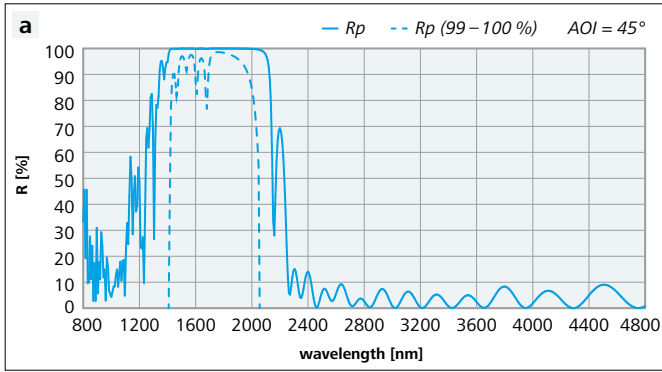
The output couplers for the signal wavelengths figure 9 can suppress the idler and vice versa figure 10. These output couplers may also have a pump window.

Turning Mirrors and Separators for AOI = 45°



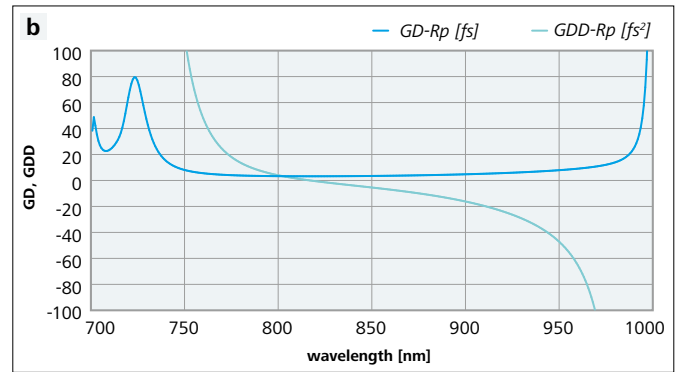
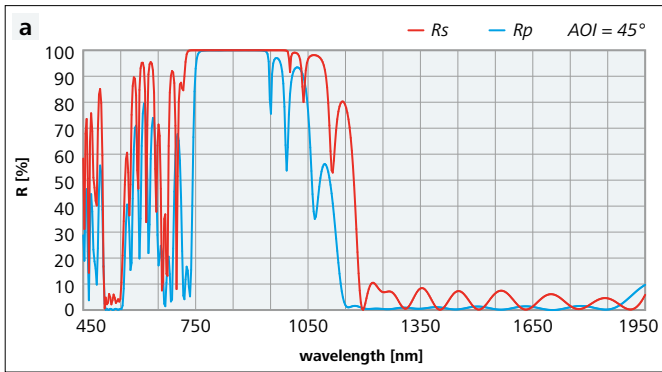
**Figure 11:** Reflectance, GD and GDD spectra of a turning mirror  $HR_p(45^\circ, 1450 - 2000 \text{ nm}) > 99.8 \%$   
**a)** Reflectance vs. wavelength  
**b)**  $GD-R_p$  and  $GDD-R_p$  vs. wavelength

Turning mirrors and separators for pump, signal and idler are key components of OPOs. The spectral position of the reflectance and transmittance bands can be adjusted according to customer specifications. Please note that GD and GDD can only be optimized for s- or p-polarization while the reflectance is usually very high for both polarizations.



**Figure 12:** Reflectance, GD and GDD spectra of a separator for signal and idler  
**a)** Reflectance vs. wavelength  
**b)** GD and GDD vs. wavelength

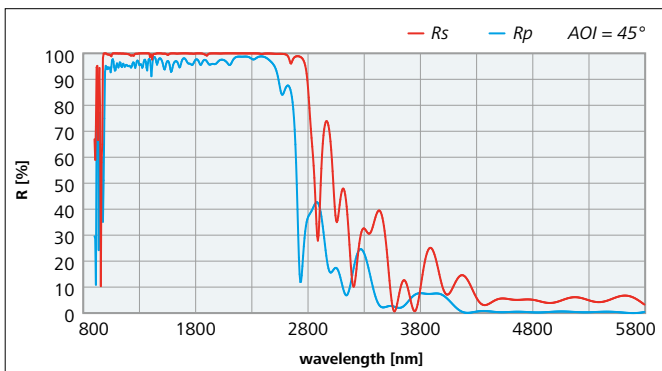
A broad reflectance band for the signal is combined with a broad transmittance band for the idler:  
 $HRp(45^\circ, 1450 - 2000 \text{ nm}) > 99.8 \% + Rp(45^\circ, 2350 - 4000 \text{ nm}) < 10 \%$ .



**Figure 13:** Reflectance, GD and GDD spectra of a separator for the signal and idler with high transmittance for the pump radiation  
**a)** Reflectance vs. wavelength  
**b)** GD and GDD vs. wavelength

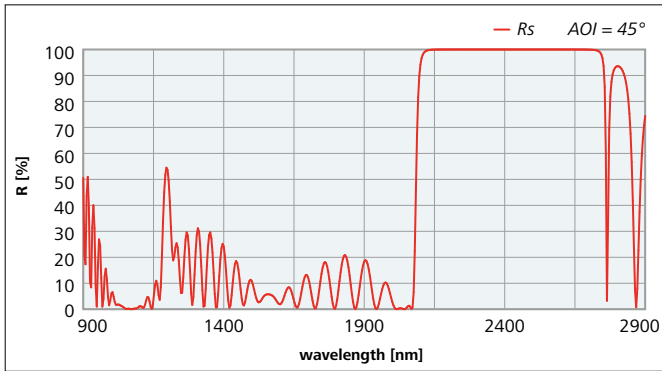
This separator can be used to couple the pump radiation into the resonator:  
 $HRs(45^\circ, 770 - 930 \text{ nm}) > 99.8 \% + Rp(45^\circ, 510 - 550 \text{ nm}) < 1 \% + Rp(45^\circ, 1160 - 1900 \text{ nm}) < 10 \%$ .

### Ultra Broadband Components for AOI = 45°

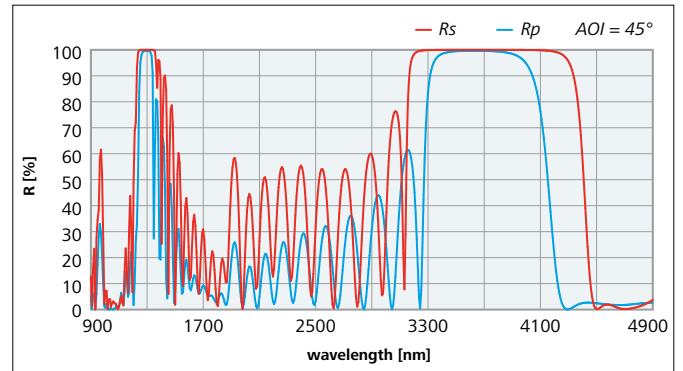


**Figure 14:** Reflectance spectrum of an ultra broadband separator for signal and idler wavelengths:  
 $HRu(45^\circ, 1000 - 2500 \text{ nm}) > 98 \%$   
 $+ Ru(45^\circ, 4400 - 5000 \text{ nm}) < 5 \%$

Edge Filters for AOI = 45°

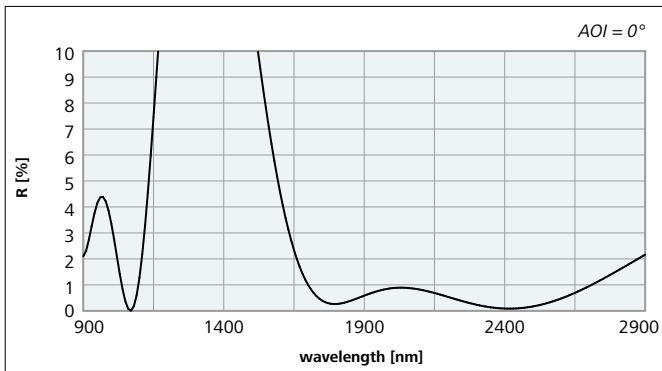


**Figure 15:** Reflectance spectrum of an edge filter for the idler and signal wavelength range with high transmittance for the pump wavelength:  
HRs (45°, 2150 – 2700 nm) > 99.9 %  
+ Rs (45°, 2000 – 2070 nm) < 10 % + Rs (45°, 1064 nm) < 1 %

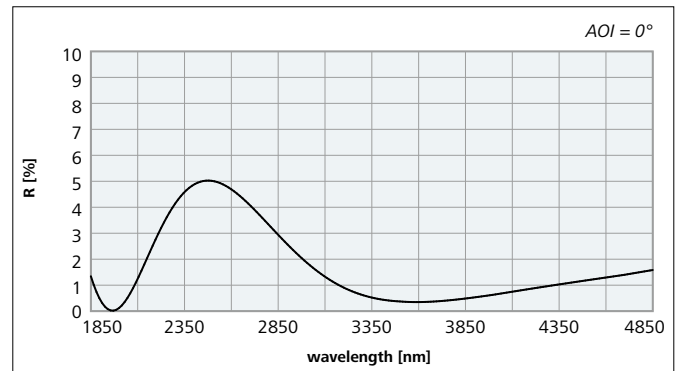


**Figure 16:** Reflectance spectrum of a broadband edge filter for the idler wavelength range with high transmittance for the pump wavelength:  
HRs (45°, 3300 – 4200 nm) > 99.9 %  
+ Rs (45°, 4500 – 4900 nm) < 6 % + Rs,p (45°, 1064 nm) < 5 %

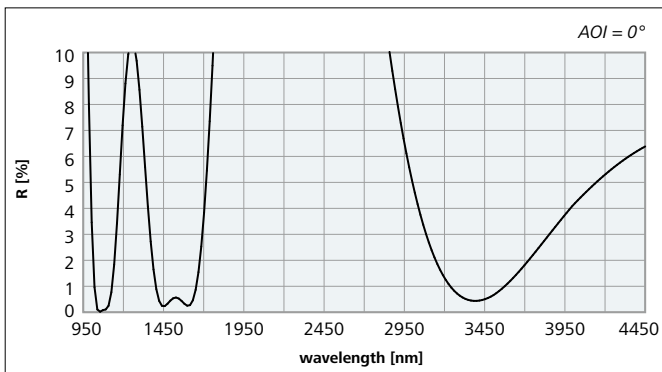
Coatings on Nonlinear Optical Crystals AOI = 0°



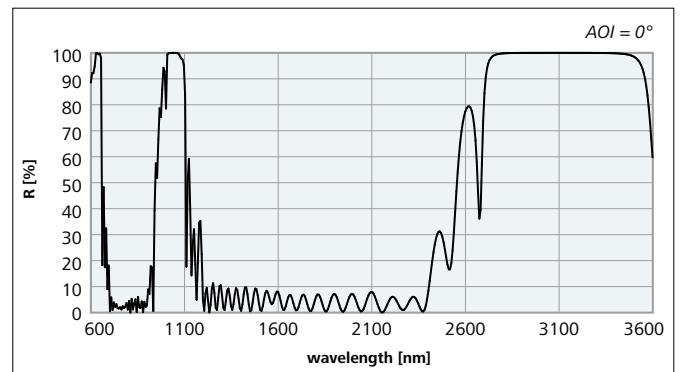
**Figure 17:** Reflectance spectrum of an AR coating on lithium niobate:  
 $R(0^\circ, 1064 \text{ nm}) < 0.5 \%$  +  $R(0^\circ, 1750 - 2750 \text{ nm}) < 1 \%$



**Figure 18:** Reflectance spectrum of an AR coating on lithium niobate:  
 $R(0^\circ, 1910 - 2030 \text{ nm}) < 0.5 \%$  +  $R(0^\circ, 3200 - 4200 \text{ nm}) < 1 \%$



**Figure 19:** Reflectance spectrum of an AR coating on lithium niobate:  
 $R(0^\circ, 1064 \text{ nm}) < 0.5 \%$   
+  $R(0^\circ, 1420 - 1640 \text{ nm}) < 0.5 \%$   
+  $R(0^\circ, 3150 - 3700 \text{ nm}) < 2 \%$



**Figure 20:** Reflectance spectrum of a double reflector with two regions of high transmittance on lithium niobate:  
HR (0°, 1010 – 1075 + 2750 – 3450 nm) > 99.8 %  
+  $R(0^\circ, 700 - 900 + 1200 - 2400 \text{ nm}) < 10 \%$

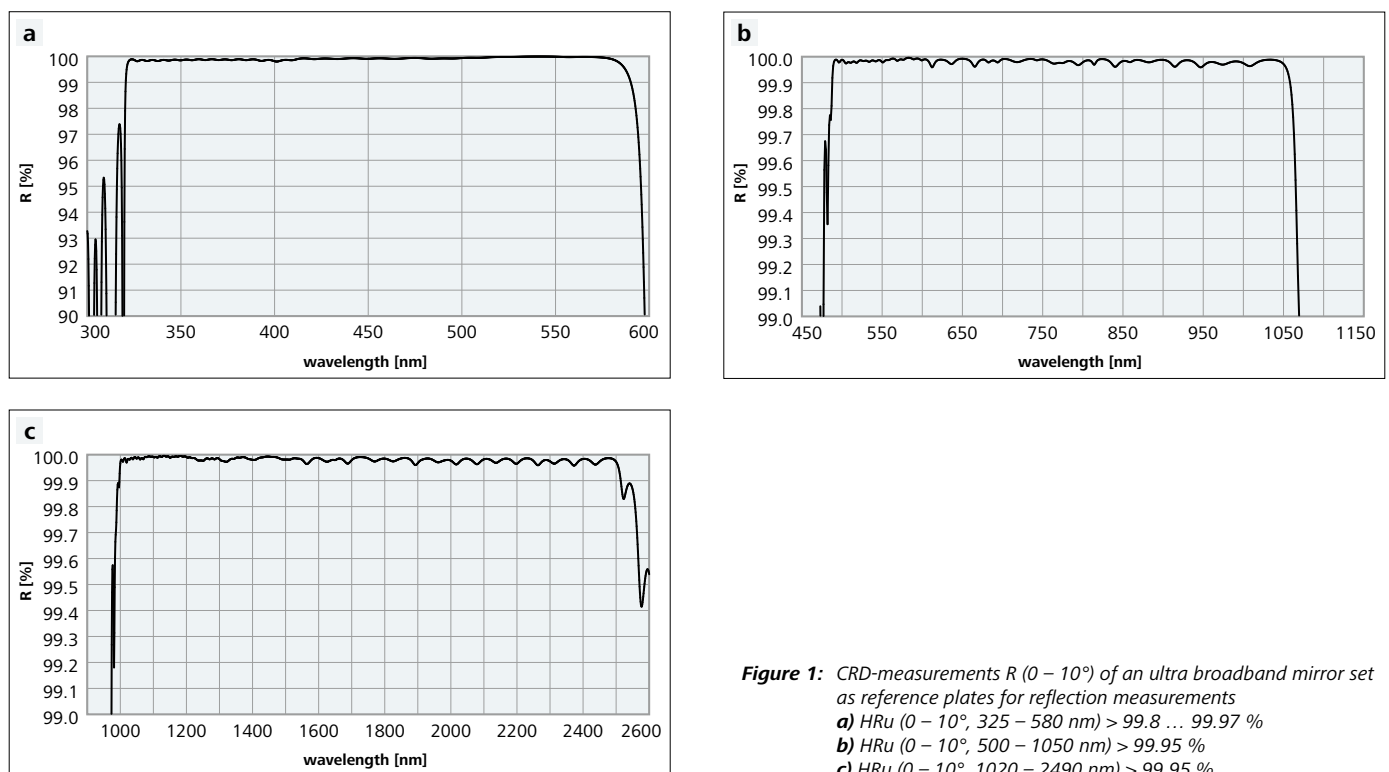
## Broadband and Scanning Mirrors (300 – 2500 nm)

LAYERTEC produces broadband and scanning mirrors according to customer specifications. Full dielectric and metal-dielectric coating designs are available. In the following, examples designed for broad wavelength regions or extremely large ranges of incidence angles are presented.

Broadband mirrors are widely used to reflect light from lasers that emit in a broad wavelength range like for example Ti:Sapphire lasers, dye lasers, or a combination of different diode lasers. Special mirrors are also available to cover the whole visible spectrum, the near ultraviolet and considerable parts of the near infrared spectral regions. LAYERTEC recommends such mirrors as universal turning mirrors for nearly all types of laser diodes.

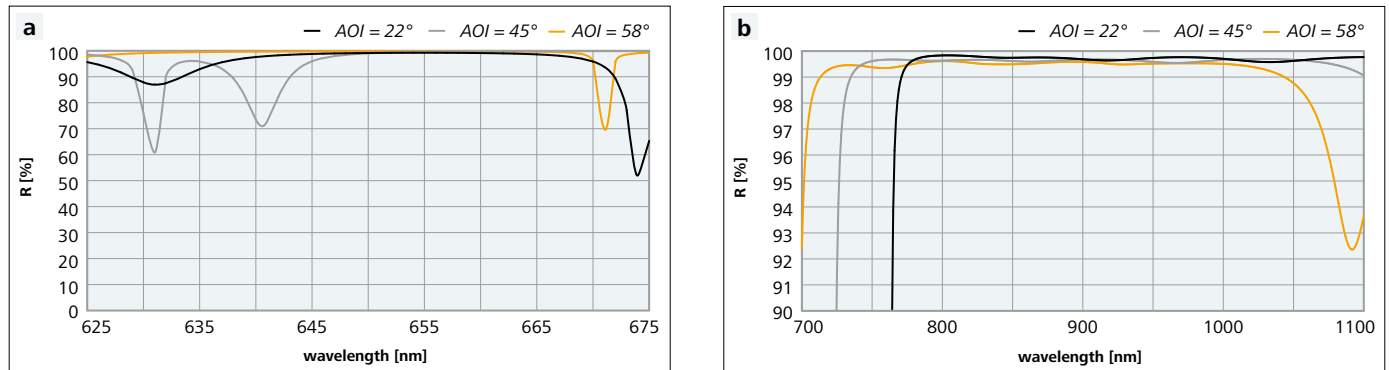
Broadband mirrors for the NIR range are especially useful for reflecting idler wavelengths of optical parametric oscillators or for special fs-applications. In combination with Fused Silica as a substrate material, a large blocking range from 2300 to 6000 nm can be achieved. Other NIR materials such as sapphire and YAG are possible alternatives. These materials can be used for high power applications to improve the cooling of the optics by the thermal conductivity of the substrate. This may be necessary if the absorption of water (around 2.8  $\mu\text{m}$ ) or of the coating material itself leads to an increase in temperature.

### Broadband Mirrors

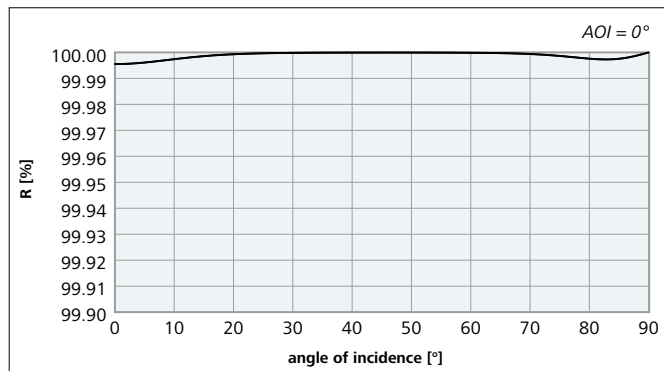


## Scanning Mirrors

LAYERTEC offers scanning mirrors for high power laser applications and for special demands with respect to wavelength and AOI range. Scanning mirrors are optimized for high reflectance for one wavelength or a certain wavelength region at a wide range of angles of incidence. LAYERTEC's coating technology provides industrial solutions for lightweight scanning mirrors as well as special mirrors with uncommon sizes up to 600 mm for research with cw and pulsed high power lasers.

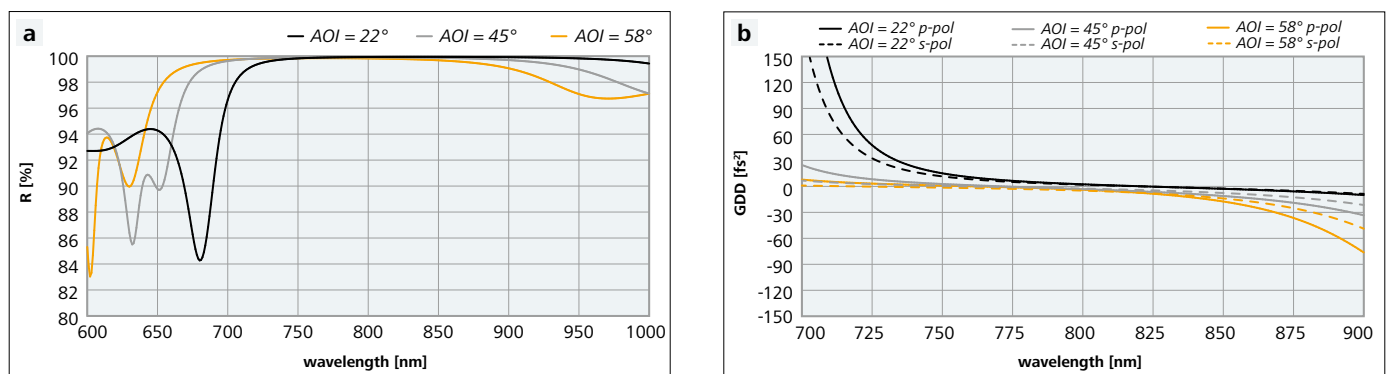


**Figure 2:** Reflectance spectra of a silver based scanning mirror with enhanced wavelength range for laser diodes in the NIR:  
HRu (22° – 58°, 800 – 1000 nm) > 99 % + Ru (22° – 58°, 630 – 670 nm) > 50 %



**Figure 3:** Reflectance vs. AOI of a wide angle scanning mirror for polarized Nd:YAG laser radiation: HRs (0° – 90°, 1064 nm) > 99.9 %

These mirrors are ideal as scanning mirrors for s-polarized light or to facilitate the production of optical gratings.

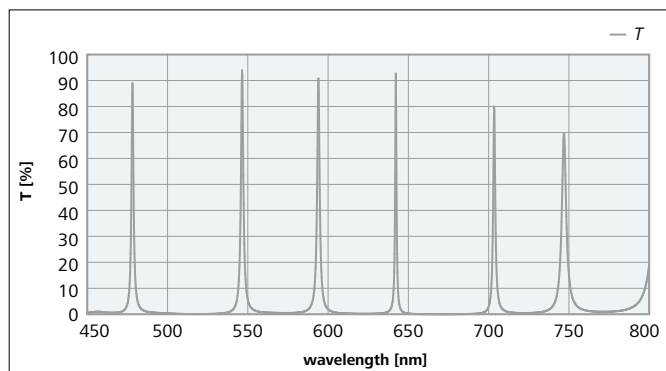


**Figure 4:** Reflectance and GDD spectra of a scanning mirror for ultrafast laser pulses from a Ti:Sapphire laser:  
HRu (22° – 58°, 750 – 850 nm) > 99.5 %, |GDD-Ru (22° – 58°, 750 – 850 nm)| < 20 fs<sup>2</sup>  
**a)** Reflectance vs. wavelength  
**b)** GDD vs. wavelength

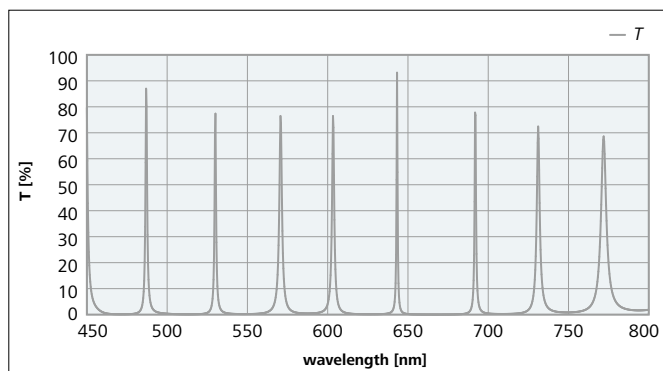
The broad low-GDD wavelength range of these mirrors makes it possible to use them in ultrafast laser applications. For more information or more examples on broadband and scanning mirrors please see page 14 ff. (optics for Ti:Sapphire and diode lasers), page 37 ff. and, especially for scanning mirrors, page 87 f. (silver mirrors).

# Filters for Laser Applications (260 – 2500 nm)

## Calibration Filters (300 – 5000 nm)



**Figure 1:** Transmission spectra of a sputtered multiline filter (VIS) to calibrate CCD-spectrometer (FWHM  $\approx$  1.5 nm at 546 nm)

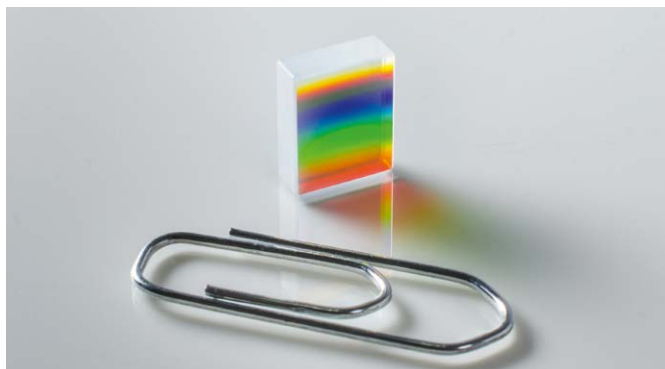


**Figure 2:** Transmission spectra of a sputtered multiline filter (VIS) to calibrate CCD-spectrometer (FWHM  $\approx$  1 nm at 546 nm)

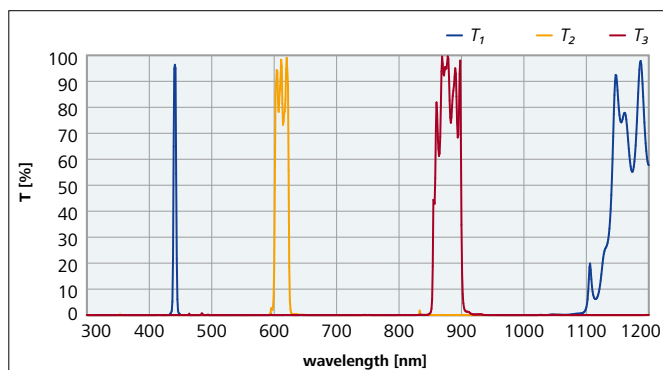
The number of lines and the spectral range are set according to customer requirements and are supplied with spectral measurement curves.

## Spectral Graduated Filters (300 – 4000 nm)

These filters are developed for building spectrometers with inexpensive (smaller) CCD camera chips.



**Figure 3:** Small gradient filter

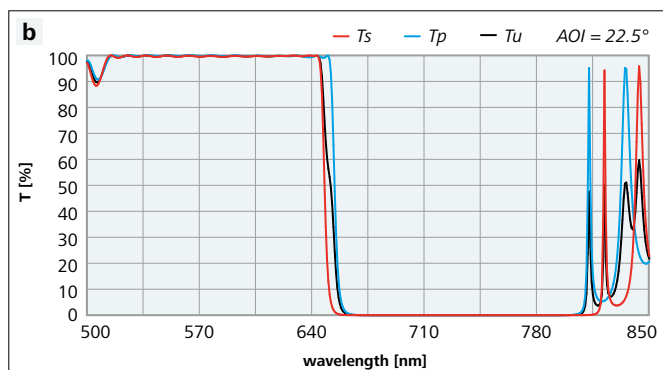
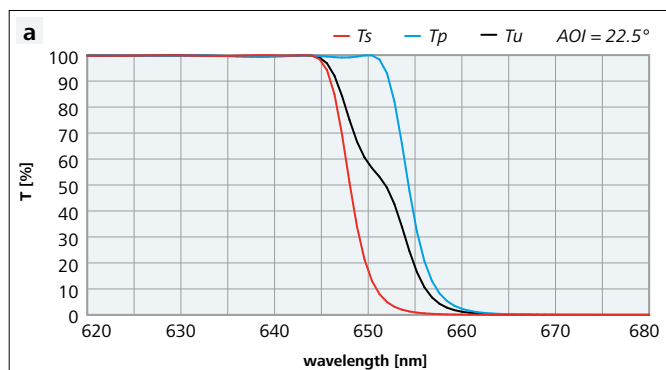


**Figure 4:** Calculated transmission for three different lateral positions of AOI = 0°

## Special Features

- Linear variation of the filter wavelength with respect to the lateral position on the filter
- Blocking range: 200 to 1300 nm with OD2 to OD4
- Filter area < sensor area  
simple geometrical adjustment by spectral pixel calibration and/or free positioning

## Step Edge Filters



**Figure 5:** Transmittance spectra of a steep edge short-wavelength pass filter for use as a combiner for laser diodes at 635 nm and 670 nm HRu (22.5°, 670 nm) > 99.9 % + Ru (22.5°, 635 nm) < 2 %, rear side AR coated)

- a)** Section around the edge of the blocking band  
**b)** Spectral overview



For more information on combiners for diode lasers see page 16. For steep edge filters used as pump mirrors for solid-state lasers based on Yb-doped materials (e.g. Yb:YAG, Yb:KGW, Yb-doped fibers) see page 18.

### Narrowband Reflectance Filters

Filters of this type are ideal for the blocking of a single laser line while preserving a high and relatively constant transmittance over the whole visible range.

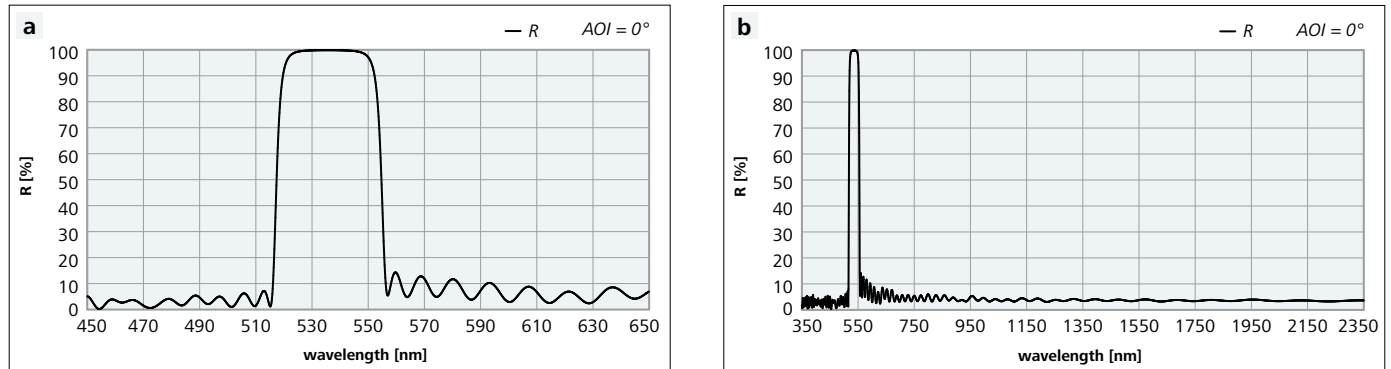


Figure 6: Reflectance spectrum of a narrowband reflectance filter for 550 nm

### Special Features

- Filters for laser applications require excellent spectral quality and high damage thresholds
- Spectral position of cut-on/cut-off wavelengths or reflectance bands according to customer specification
- Sizes and shapes: Edge filters can be produced on round or rectangular substrates up to diameters of 38.1 mm (1.5 inch). The production of miniature size filters (e.g. 3 × 3 mm<sup>2</sup>) is possible. Narrowband reflectance filters are limited to diameters of 25.4 mm (1 inch).
- Optical parameters are environmentally stable

### Dual Wavelength Filters with Broad Blocking Range

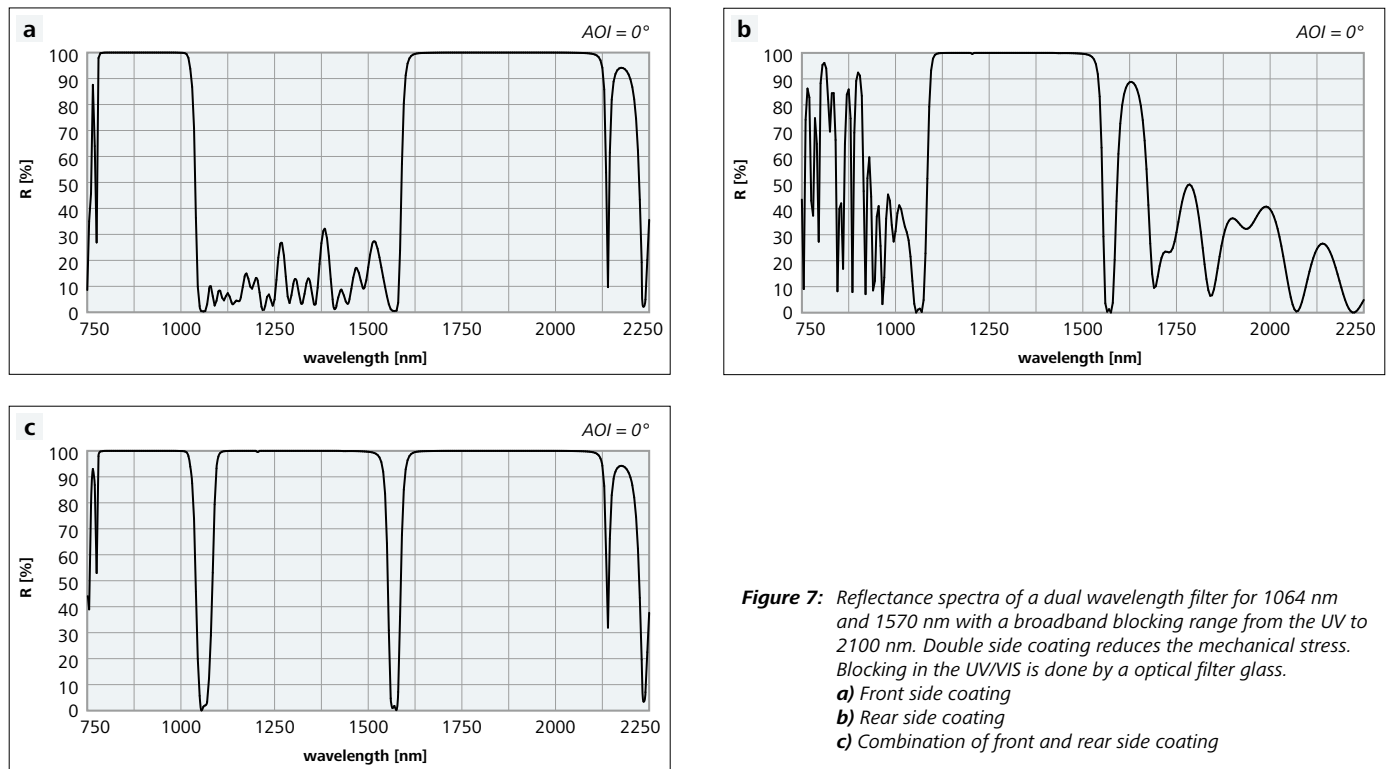
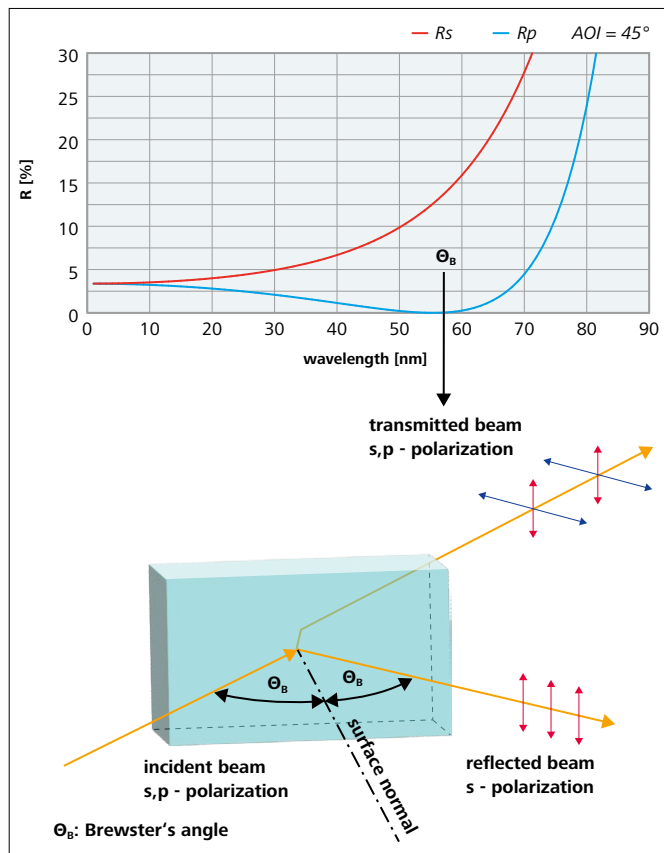


Figure 7: Reflectance spectra of a dual wavelength filter for 1064 nm and 1570 nm with a broadband blocking range from the UV to 2100 nm. Double side coating reduces the mechanical stress. Blocking in the UV/VIS is done by an optical filter glass.

- a) Front side coating
- b) Rear side coating
- c) Combination of front and rear side coating

## Thin Film Polarizers

In order to answer frequently asked questions and to help LAYERTEC's customers to specify thin film polarizers, definitions of the most important technical terms are given here.



**Figure 1:** Explanation of the terms “s-polarized light” and “p-polarized light” and reflectance of an uncoated glass surface vs. angle of incidence for s- and p-polarized light

Light is a transversal wave; the vector of the electric field oscillates perpendicular with respect to the propagation direction of the light. Natural light (from the sun or from a lamp) is mostly “unpolarized”. This means that the oscillation planes of the electric field vectors of the single light waves are randomly distributed, but always transversal with respect to the direction of propagation. In contrast, the term “linearly polarized light” signifies that there is only one plane of oscillation. There are different optics which can polarize light. An example of this would be crystal polarizers which split light into an unpolarized “ordinary beam” and a polarized “extraordinary beam” or thin film polarizers.

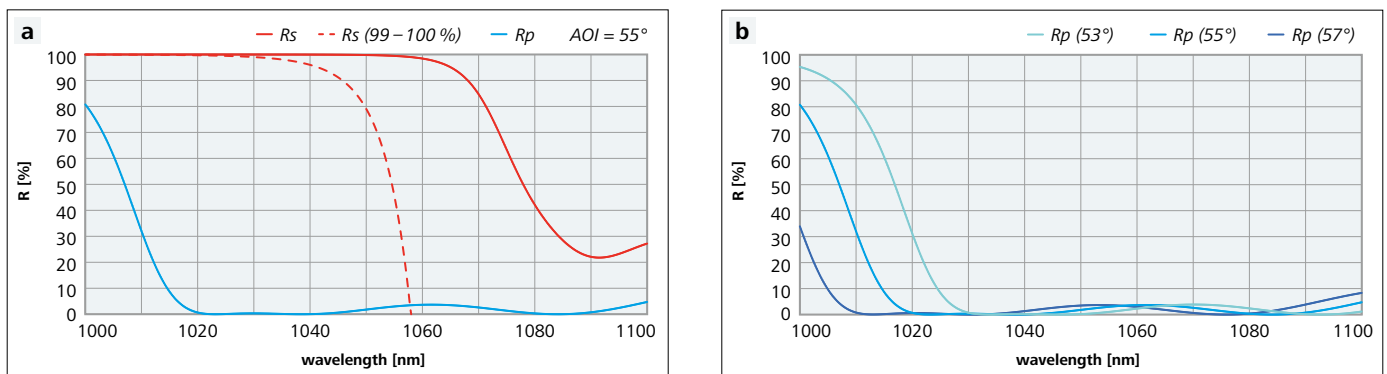
To explain the meaning of the terms “s-polarization” and “p-polarization”, first a reference plane must be determined (see figure 1). This plane is spanned by the incident beam and by the surface normal of the mirror (or polarizer). “S-polarized light” is the part of the light which oscillates perpendicular to this reference plane (“s” comes from the German word “senkrecht” = perpendicular). “P-polarized light” is the part which oscillates parallel to the reference plane. Light waves with a plane of oscillation inclined to these directions can be described as having a p-polarized and an s-polarized part.

The upper part of figure 1 shows the reflectance of an uncoated glass surface vs. AOI for s- and p-polarized light. The reflectance for s-polarized light increases with rising angle of incidence. In contrast, the reflectance of p-polarized light decreases until reaching  $R = 0$  at the “Brewster’s angle”, then increases for angles of incidence beyond the Brewster’s angle. In principle, the same is true for dielectric mirrors. Thin film polarizers separate the s-polarized component of the light from the p-polarized component using the effect that s-polarized light possesses a higher reflectance and broader reflection band than p-polarized light.

There always is a wavelength range, where  $R_s$  is close to 100 % while  $R_p$  is close to zero. Special coating designs are used to make this wavelength range as broad as possible and to maximize the polarization ratio  $T_p/T_s$ . Very high values of  $T_p$  ( $> 99.5$  %) can be measured very precisely using a special Cavity Ring-Down set-up. The TFP is inserted into a cavity thus introducing additional losses equal to  $100 \% - T_p$ .

Utilizing this method, the most beneficial AOI for each TFP can be determined. Thin film polarizers (TFPs) are key components in a wide variety of applications, e.g. in regenerative amplifiers. LAYERTEC produces thin film polarizers on plane substrates (dimensions according to customer specifications) for wavelengths between 260 nm and 2500 nm. All TFPs are optimized for high laser-induced damage thresholds. Although there are no certified measurements available, LAYERTEC has learned from several customers that the LIDT of a TFP is approximately one third of the LIDT of a highly reflecting mirror for the same wavelength coated using the same technology.

## Standard Thin Film Polarizers



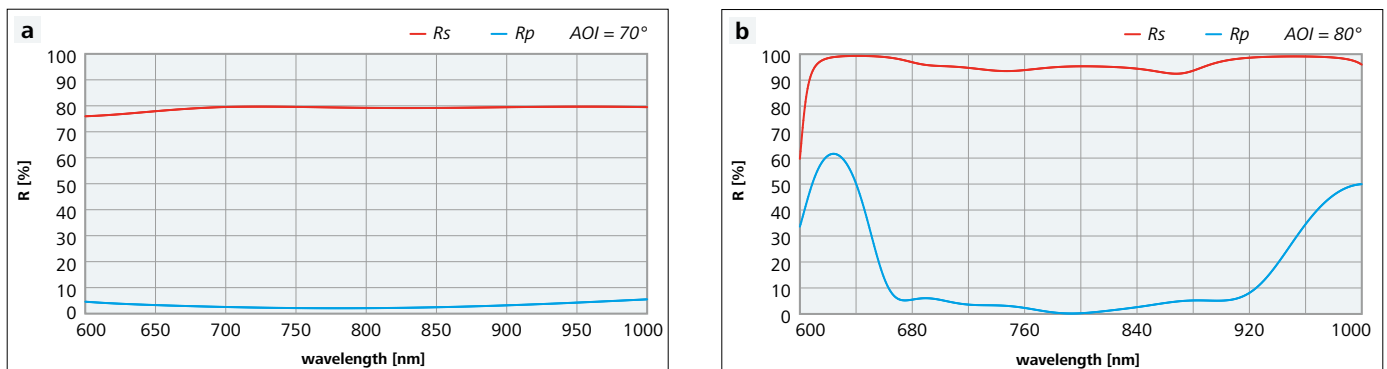
**Figure 2:** Reflectance spectra

**a)** of a standard TFP for 1030 nm at AOI = 55° (Brewster's angle) for s- and p-polarized light

**b)** of the same TFP design for AOI = 53°, 55° and 57° for p-polarized light (angle adjustment decreases Rp at 1030 nm from 0.25 % to < 0.1 % thus giving the option to optimize the polarization ratio)

- TFPs can be produced for AOI > 40°. Please note that thin film polarizers working at the Brewster's angle exhibit a considerably broader bandwidth and a higher Tp/Ts ratio than those working at AOI = 45°.
- Typical polarization ratios Tp/Ts standard: > 500 (AOI = 45° or 55°)
- An extended wavelength range with a limited polarization ratio can be obtained by choosing AOI beyond the Brewster's angle
- Special designs with a polarization ratio of Tp/Ts up to 10 000 are possible
- High laser-induced damage thresholds (useful for intra cavity applications)
- It is beneficial to design the laser in a way that the polarizers can be tilted by ±2° to adjust the polarizer to its best performance
- The standard design can be used for wavelengths between 260 nm and 2500 nm

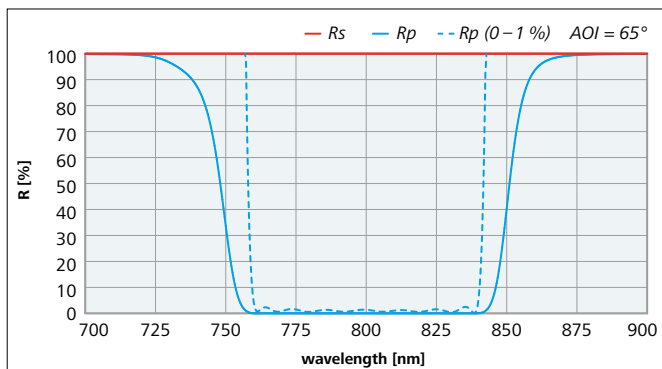
## Special Thin Film Polarizers



**Figure 3:** Broadband TFPs for the wavelength range of the Ti:Sapphire laser with different bandwidths and different polarization ratios, working at AOI = 70° and AOI = 80°

**a)** Rp and Rs vs. wavelength, TFP designed for AOI = 70°

**b)** Rp and Rs vs. wavelength, TFP designed for AOI = 80°



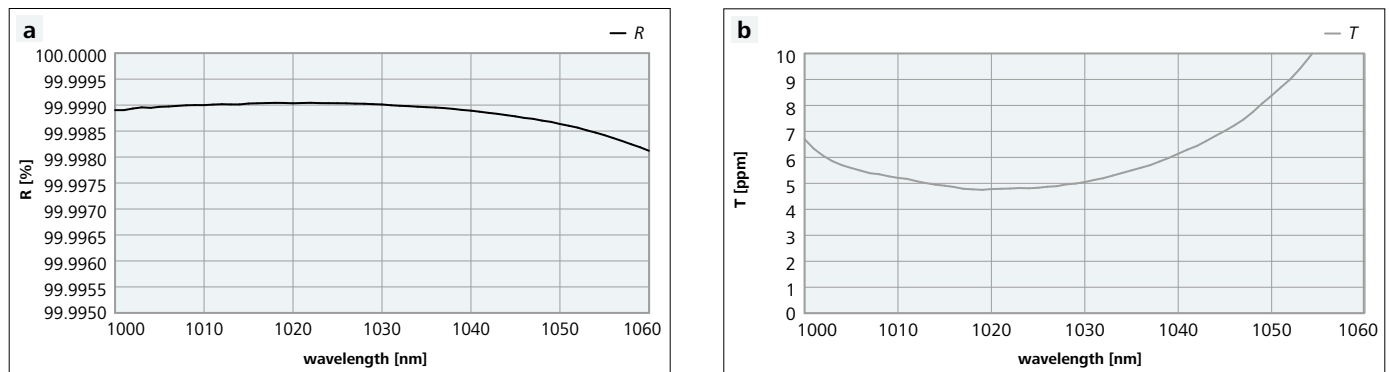
**Figure 4:** Broadband TFP for the 800 nm region

This special design provides an extremely broad polarizing wavelength range ( $\pm 10\%$  of the center wavelength) with Tp/Ts = 300 to 1000.

# Low Loss Optical Components (340 – 3000 nm)

## HR Mirrors

- $R > 99.99\%$  in the VIS and NIR spectral range
- $R > 99.999\%$  was demonstrated at several wavelengths between 1000 – 1600 nm
- Mirrors with defined transmittance (e.g.  $T = 0.002\%$ )
- For Cavity Ring-Down time spectroscopy, it is favorable to adjust the transmittance to the value of the scattering and absorption losses ( $T = S + A$ )
- All mirrors for CRD experiments are delivered with rear side AR coating. Wedged substrates on request
- Plane and spherically curved Fused Silica substrates
- Premium polish, RMS roughness:  $\leq 0.15$  nm (see table 2 on page 136)
- Surface imperfection tolerance:  $5/1 \times 0.010$  (ISO 10110) for  $\varnothing 25$  mm
- Coating technique: magnetron sputtering, ion beam sputtering
- Optical parameters are stable against changes in temperature and humidity
- Attractive prices for small and medium numbers of substrates per coating run
- Very high reflectance values for complex coating designs, e.g. GTI laser mirrors with  $R > 99.95\%$  (see page 64 f.)
- Vacuum packaging or packaging under nitrogen cover gas in dust free boxes
- Designed for vacuum application



**Figure 1:** Example: low loss mirror for 1030 nm  
 Substrate: Fused Silica plano-concave ROC = 1000 mm polished at LAYERTEC  
 Coating: PR ( $0^\circ$ , 1030 nm)  $> 99.9985\%$  + T ( $0^\circ$ , 1030 nm)  $\approx 5$  ppm (magnetron sputtering)  
 CPI-absorption measurement A ( $0^\circ$ , 1030 nm)  $< 1$  ppm; S ( $0^\circ$ , 1030 nm) =  $1 - T - R - A \approx 4$  ppm  
**a)** Cavity-Ring-Down measurement  $0^\circ$   
**b)** Transmission measurement  $0^\circ$

### Important note for an order

The following balance equation applies:

$1 = \text{Reflectance } R + \text{Transmittance } T + \text{Losses } L$  with

$L = \text{Absorbance } A + \text{Scattered Light } S$

Please specify the transmittance required for the application. LAYERTEC has dealt with the reduction of optical losses for many years and knows about the typical values of absorption and scattering in the NUV, VIS and NIR spectral range. Based on this experience LAYERTEC calculates the achievable reflectance from:

$$R = 1 - T - V$$

e.g.

Customer: T ( $0^\circ$ , 633 nm) = 10 ppm ( $\pm 5$  ppm)

LAYERTEC: V ( $0^\circ$ , 633 nm)  $< 25$  ppm (typically  $< 20$  ppm)

Specification: R ( $0^\circ$ , 633 nm)  $> 99.996\%$

Customer: T ( $0^\circ$ , 390 nm) = 100 ppm ( $\pm 20$  ppm)

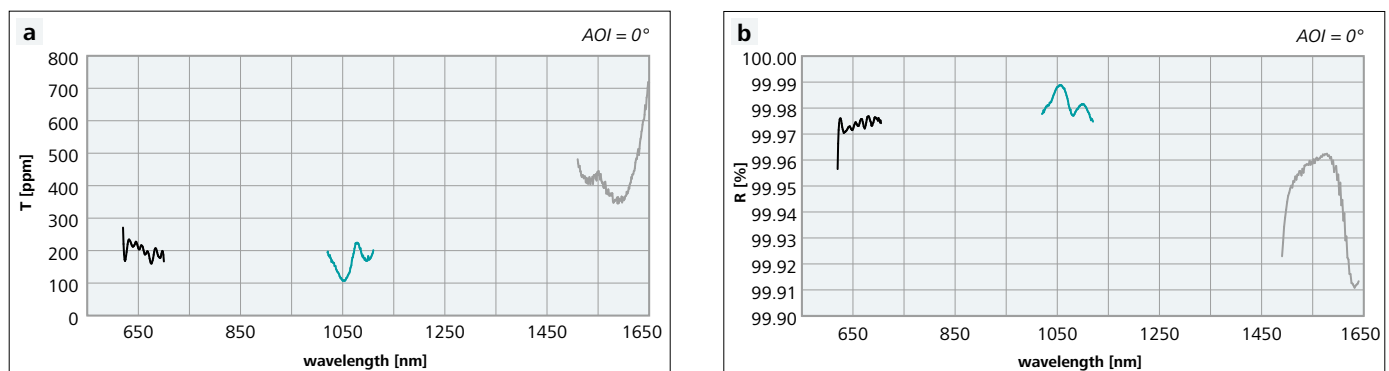
LAYERTEC: V ( $0^\circ$ , 390 nm)  $< 50$  ppm

Specification: R ( $0^\circ$ , 390 nm)  $> 99.983\%$

## Cavity Ring-Down time measurements and reference data

**Table 1:** Reflectance and transmittance values of LAYERTEC low loss mirrors; reflectance measured by Cavity Ring-Down spectroscopy, AOI = 0°

Wavelength	R <sub>max</sub>	T	Loss L = 1 - R - T	Measured at
248 nm	99.87 %	0.00024 %	1300 ppm	LAYERTEC GmbH
266 nm	99.941 %	0.0031 %	560 ppm	LAYERTEC GmbH
355 nm	99.983 %	0.0105 %	65 ppm	LAYERTEC GmbH
380 nm	99.988 %	0.007 %	50 ppm	LAYERTEC GmbH
550 nm	99.9977 %	0.00039 %	19 ppm	LAYERTEC GmbH
633 nm	99.992 %	0.006 %	20 ppm	Westsächsische Hochschule Zwickau, Germany
660 nm	99.992 %	0.006 %	20 ppm	Heidelberg University, Germany
689 nm	99.9982 %	0.0005 %	13 ppm	LAYERTEC GmbH
798 nm	99.995 %	0.003 %	10 ppm	LAYERTEC GmbH
840 nm	99.9988 %	0.0002 %	10 ppm	LAYERTEC GmbH
1030 nm	99.9980 %	0.0012 %	8 ppm	LAYERTEC GmbH
1150 nm	99.9994 %	0.00035 %	2.5 ppm	LAYERTEC GmbH
1392 nm	99.9985 %	0.0007 %	8 ppm	TIGER OPTICS, USA (R measurement) LAYERTEC GmbH (T measurement)
1550 nm	99.999 %	0.0002 %	8 ppm	IPHT Jena, Germany
2350 nm	99.995 %	0.002 %	30 ppm	University of Grenoble, France
3250 nm	99.928 %	0.012 %	600 ppm	University of Grenoble, France
4000 nm	99.9 %	—	—	Bielefeld University, Germany



**Figure 2:** Example of a low loss mirror for three wavelength ranges:  
 $PR(0^\circ, 630 - 710 \text{ nm} + 1030 - 1110 \text{ nm}) = 99.98 (\pm 0.015) \%$  +  $PR(0^\circ, 1550 - 1565 \text{ nm}) = 99.965 (\pm 0.025) \%$ ;  
 $T(0^\circ, 630 - 710 + 1030 - 1110 + 1550 - 1565 \text{ nm}) \approx 100 \dots 400 \text{ ppm}$ ;  
 measured losses:  $(0^\circ, 660 \text{ nm}) \approx 140 \text{ ppm}$ ;  $L(0^\circ, 1070 \text{ nm}) \approx 10 \text{ ppm}$ ;  $L(0^\circ, 1555 \text{ nm}) \approx 10 \text{ ppm}$

### Notes

- Losses = absorption + scattered light; with absorption  $\ll$  scattered light
- Losses = f (polished surface, wavelength, coating technology, design and defects)
- E.g. scattered light of a plane or curved surface < scattered light of a concave surface combined with a plane chamfer for bonding

The development of low loss optics is highly dynamic. The tabular values are therefore guidelines for specific customer requests.

## Coatings on Crystal Optics (340 – 3000 nm)

Laser applications using crystal optics have reached a high standard in industry and research. Optical coatings on crystals are an essential part of modern laser designs. They cover a wide range from single wavelength AR coatings on laser and nonlinear optical crystals up to complex multilayer coatings providing several high reflectance and high transmittance wavelength ranges and thus, replacing external laser mirrors. LAYERTEC has a lot of experience in coating laser crystals. LAYERTEC coatings are used in industrial high power Q-switched and cw lasers of several laser manufacturers. The quality of coatings on crystals depends on the coating technique as well as on the surface quality of the crystal. All coatings are produced using sputtering techniques which guarantee very low scattering losses and high environmental stability of the optical parameters.

The rapid progress in crystal growth techniques resulted in a wide variety of new crystals for laser applications, e.g. laser crystals like tungstanates and vanadates or nonlinear optical crystals like RTP. Each crystal type requires optimized polishing procedures and coating techniques. The coating design is determined by the optical properties of the crystal. However, the thermal expansion coefficients and the surface quality after storage and transport influence the coating quality as well. Especially, hygroscopic crystals like LBO or BBO require special pretreatments to achieve high damage thresholds and long lifetime for the coatings. Thus, coatings on new crystals always require experimental investigations to find the best coating procedures. Different dimensions and uncommon sizes and shapes are possible using the special LAYERTEC coating technology. The following table gives an overview about the crystals which have already been coated at LAYERTEC and the types of layer systems which have been applied successfully.

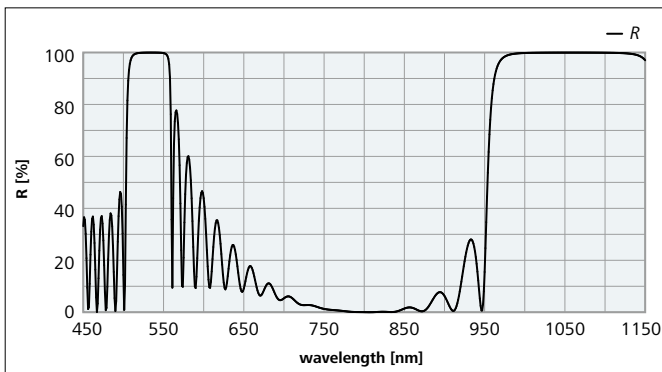
**Table 1:** Examples of available coatings on crystals

Crystal Type	AR/BBAR	Single HR optional with HT	Double HR/BBHR optional with HT
$\alpha$ -SiO <sub>2</sub> (Quartz)	x	x	x
BBO	x	—	—
BiBO	x	x	
CaCO <sub>3</sub>	x		
CdMnTe	x		
CTA	x		
Nd:GdVO <sub>4</sub>	x	x	x
Nd:GGG	x	x	
Nd:Cr:GSGG	x	x	
KTA	x	x	
KTP	x	x	x
Yb:KGW, Yb:KYW	x	x	x
LBO	x	—	—
LiNbO <sub>3</sub>	x		
LMA	x		
Nd:LSB	x	x	x
RTP	x		
Ruby	x	x	x
Ti:Sapphire	x	x	x
Spinell	x	x	x
Cr:YAG	x	x	x
Er:YAG	x	x	x
Ho:YAG	x	x	x
Nd:YAG, Yb:YAG	x	x	x
Nd:YALO (YAP)	x		
YLF	x		
Nd:YVO <sub>4</sub>	x	x	x
ZGP	x		
ZnSe	x	x	

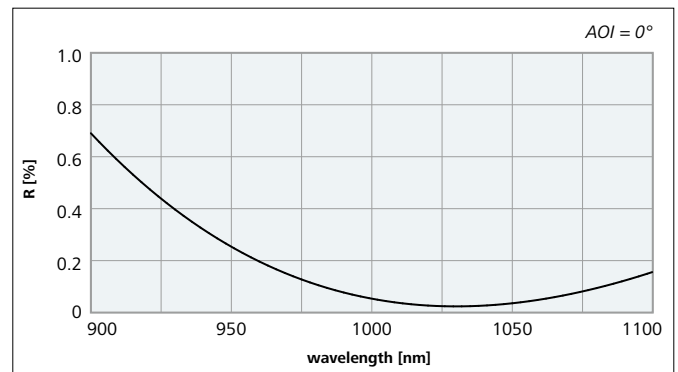
x: established coating process  
 —: not possible due to technical reasons  
 empty box: not requested yet

Detailed measurement reports are available for each batch. Do not hesitate to contact LAYERTEC for a discussion or a quotation regarding your special coating project.

## Coatings on Doped Laser Crystals



**Figure 1:** Reflectance spectrum of a dual HR mirror with an HT region for pumping with a laser diode (on Nd:YAG):  
HR (0°, 532 nm + 1064 nm) + HT (0°, 808 nm)

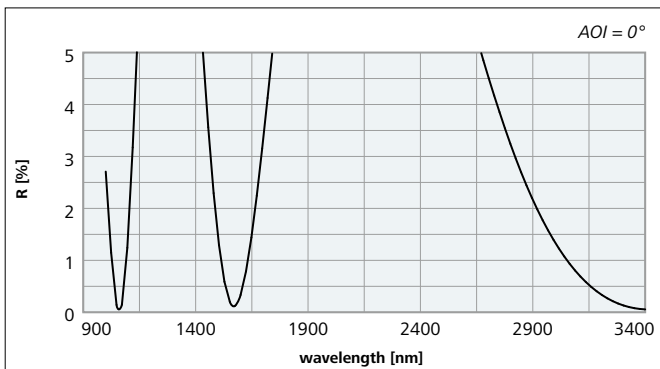


**Figure 2:** Reflectance spectrum of an AR coating for an Yb:KYW crystal:  
AR (0°, 1030 nm) < 0.2 % + AR (0° – 30°, 980 nm) < 0.2 %.  
Please note the large acceptance angle for the pump radiation

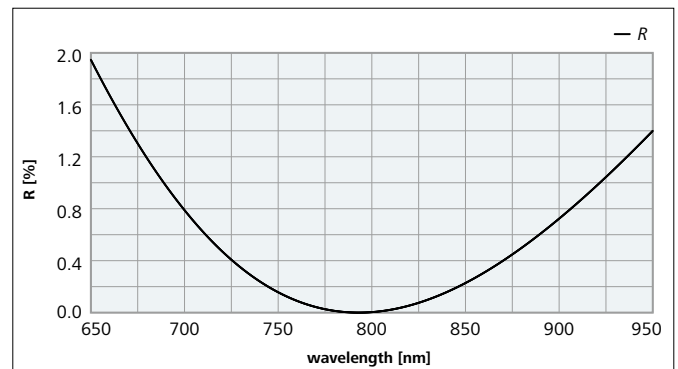
### Sputtered coatings on laser rods, discs and slabs with:

- High laser-induced damage thresholds for critical industrial applications of Q-switched and cw lasers
- Low residual reflectance
- Broadband and multiple wavelength AR coatings
- Complex HR and HR/HT-coatings for compact laser designs, e.g. HR (0°, 532 nm + 1064 nm) > 99.9 % + R (0°, 808 nm) < 5 %, on Nd:YVO<sub>4</sub> for diode-pumped and frequency-doubled “green” lasers)
- Coating of crystals with variable or special sizes and shapes
- Coating of the full aperture of small crystals

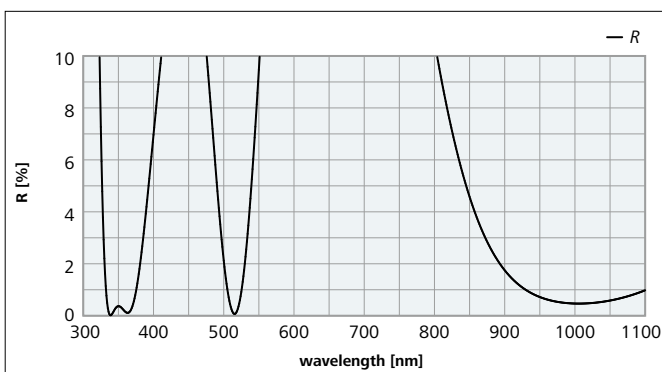
## Coatings on Nonlinear Optical Crystals



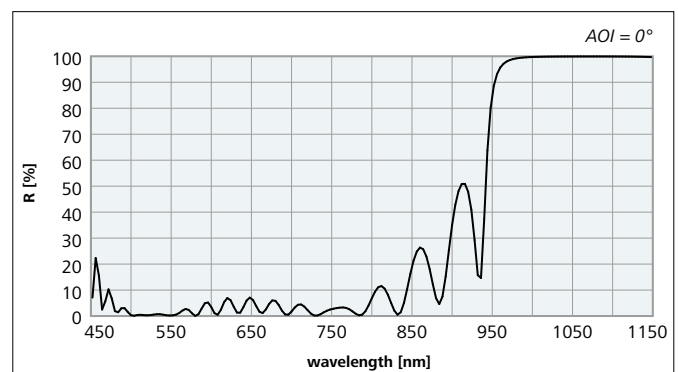
**Figure 3:** Reflectance spectrum of a triple wavelength AR coating on KTP:  
AR (0°, 1064 nm + 1575 nm + 3400 nm) < 0.5 %



**Figure 4:** Reflectance spectrum of an AR-coating:  
AR (0°, 750 – 850 nm) < 0.5 % on CdMnTe



**Figure 5:** Reflectance spectrum of a triple wavelength AR-coating:  
R (0°, 343 nm + 515 nm + 1030 nm) < 0.75 % on BBO



**Figure 6:** Reflectance spectrum of a dichroic mirror on KTP:  
R (0°, 532 nm) < 1 % + HR (0°, 1064 nm) > 99.95 %

# Metallic Coatings

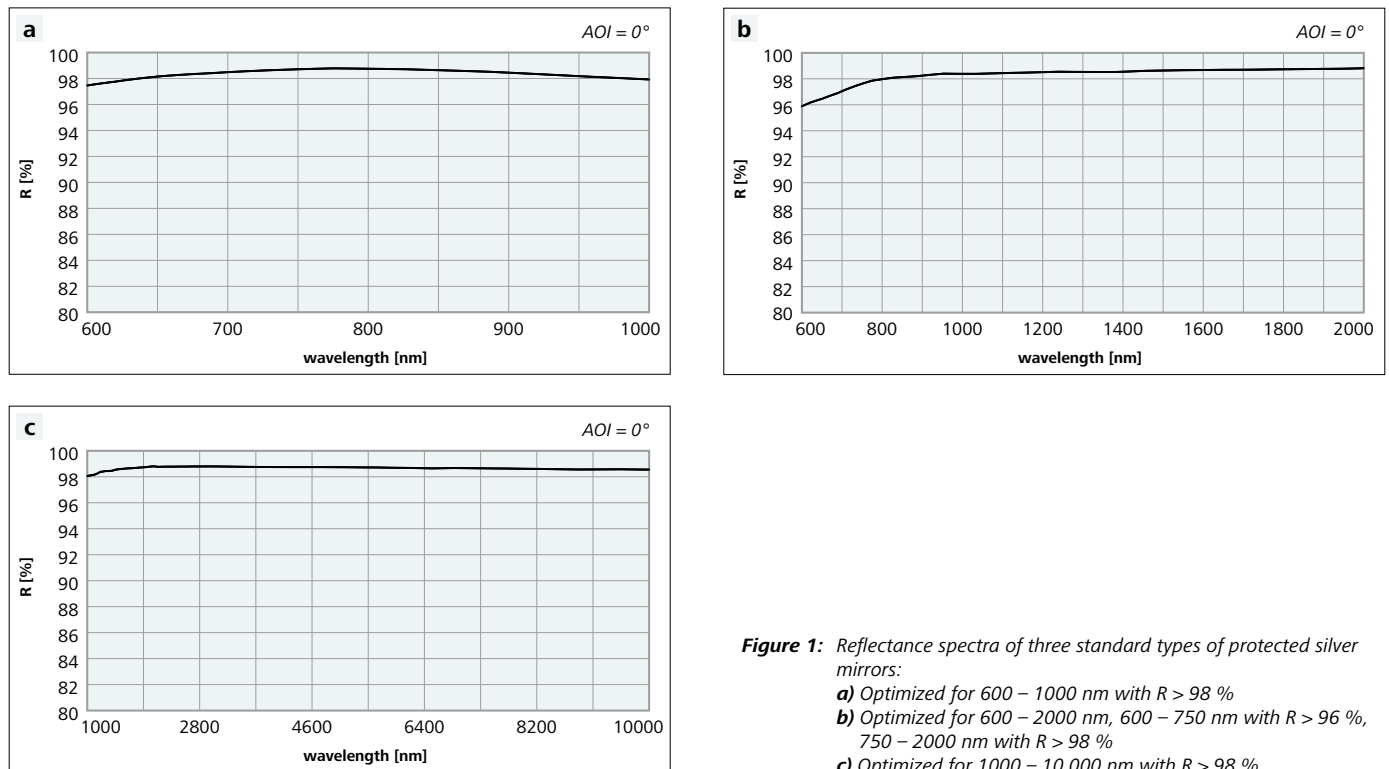
## Chapter Index

<b>Front Surface Silver Mirrors (400 – 4000 nm).....</b>	<b>87</b>
Broadband Silver Mirrors for the VIS and NIR .....	87
Silver Mirrors for Use in Ultrafast Lasers.....	88
Silver Mirrors with Enhanced Reflectance .....	88
<b>Front Surface Aluminum Mirrors (150 – 900 nm) .....</b>	<b>90</b>
Broadband Mirrors for the UV, VIS and NIR .....	90
Aluminum Mirrors for Multiple Wavelength and Ultrafast Applications .....	90
Protected Aluminum Mirrors for the DUV and VUV .....	91
Enhanced Aluminum Mirrors for 157 nm.....	92
Enhanced Aluminum Mirrors for 193 nm.....	92
<b>Special Metallic Coatings (400 – 10 000 nm).....</b>	<b>93</b>
Chromium Coatings for Optical Applications .....	93
Broadband Neutral Density Filters for the NIR.....	93
Solderable Coatings.....	93
Gold Mirrors for the NIR Spectral Range.....	94
Partially Transmissive Gold Layers for Optical and Non-optical Applications .....	94



# Front Surface Silver Mirrors (400 – 4000 nm)

## Broadband Silver Mirrors for the VIS and NIR



**Figure 1:** Reflectance spectra of three standard types of protected silver mirrors:

- a)** Optimized for 600 – 1000 nm with  $R > 98\%$
- b)** Optimized for 600 – 2000 nm, 600 – 750 nm with  $R > 96\%$ , 750 – 2000 nm with  $R > 98\%$
- c)** Optimized for 1000 – 10 000 nm with  $R > 98\%$

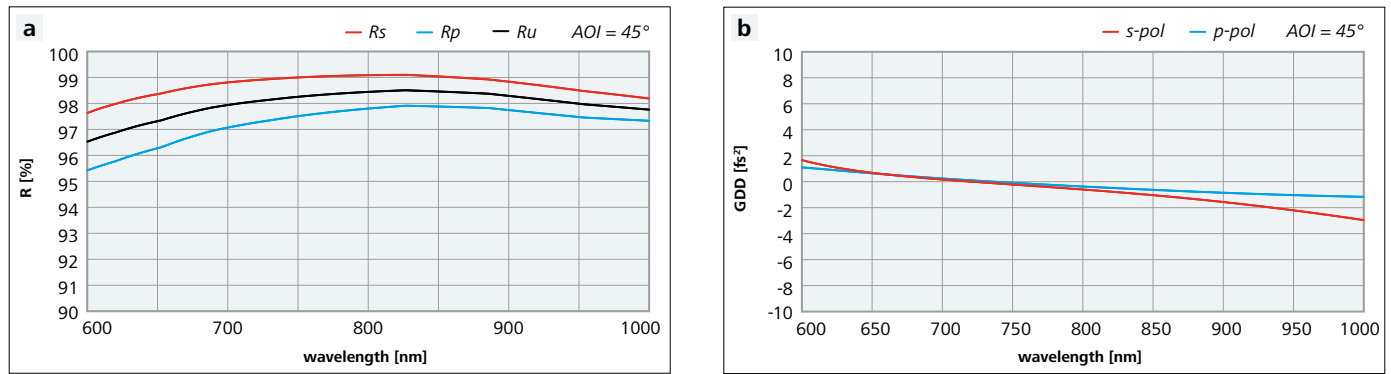
### Optical Properties

- $R > 98\%$  throughout the specified wavelength range (except figure 1b)
- $R = 94 \dots 97\%$  in the VIS outside the specified wavelength range
- $R > 97\%$  in the NIR outside the specified wavelength range

### Special Features

- Silver has the highest reflectance of all metals in the VIS and NIR
- Sputtered protective layers yield very stable optical parameters
- Lifetime of more than 10 years in normal atmosphere has been demonstrated although unprotected silver is chemically unstable
- The high atomic density of sputtered coatings guarantees that even very thin protective layers ( $\approx 20$  nm) provide a good protection against the atmosphere
- The thickness of the protective layer can be used to optimize the reflectance of the mirrors for different wavelength ranges (see figure 1)
- Sputtered silver mirrors show extremely low scattering losses. (total scattering  $TS \approx 30$  ppm in the VIS and NIR)
- Silver mirrors with defined transmittance (e.g.  $T = 0.01\%$ ) on request (see 52 f.)
- Mechanical stability of protected silver mirrors is tested according to MIL-M-13508C § 4.4.5
- Maximum diameter: 600 mm, especially for astronomical applications

**Silver Mirrors for Use in Ultrafast Lasers**



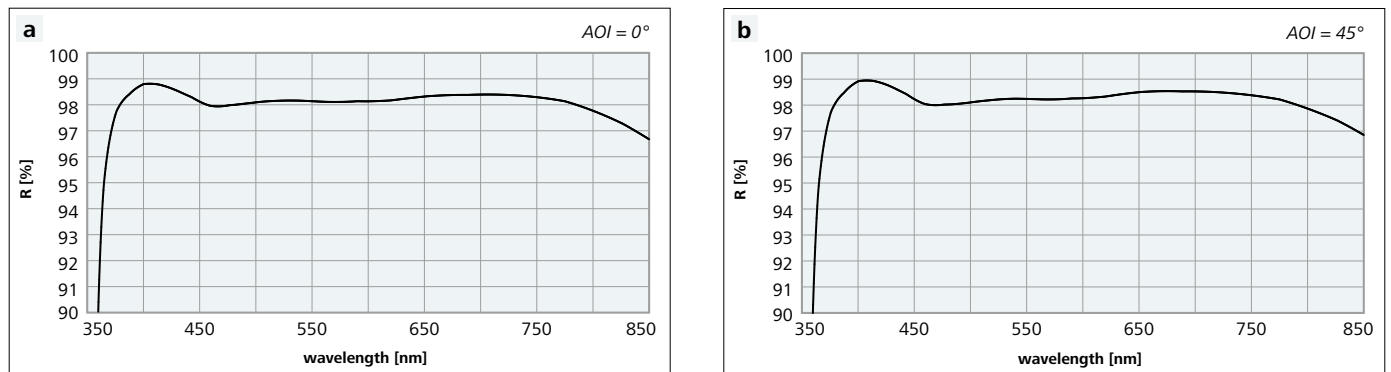
**Figure 2:** Reflectance and GDD spectra of a silver mirror optimized for use with ultrafast lasers in the wavelength range 600 – 1000 nm (AOI = 45°)  
**a)** Reflectance vs. wavelength  
**b)** GDD vs. wavelength

Silver mirrors are ideal in ultrafast laser systems because of their extremely broad low-GDD reflectance band. For more examples see page 52 f.

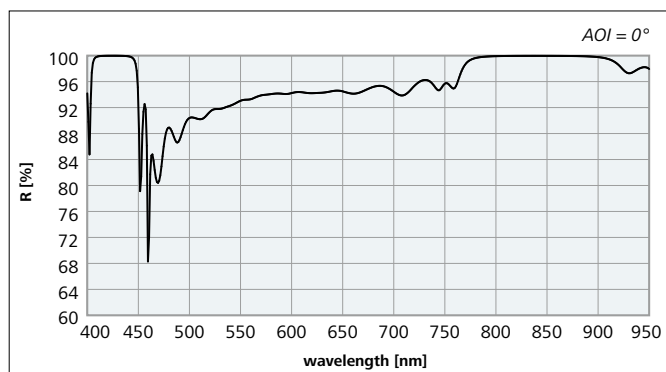
**Silver Mirrors with Enhanced Reflectance**

The reflectance of silver mirrors can be enhanced for selected wavelengths or wavelength regions by a dielectric protective coating. Figure 3 to figure 5 show examples for silver mirrors with enhanced reflectance. Such mirrors combine very high reflectance at the wavelengths of interest with a relatively high reflectance throughout the VIS which makes them ideal for use in conjunction with alignment lasers.

**Mirrors for Astronomical Applications**

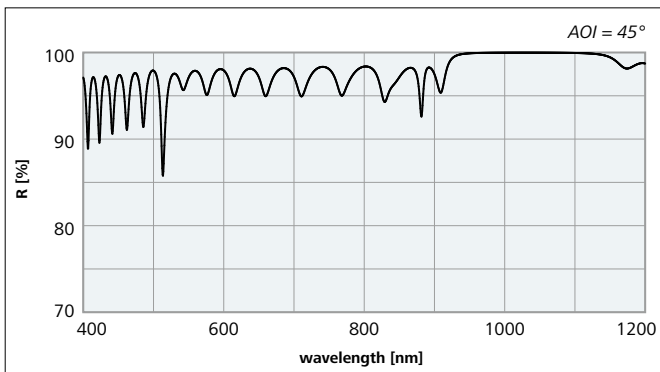


**Figure 3:** Reflectance spectra of an enhanced silver mirror which shows  $R \geq 98\%$  throughout the visible spectral range:  
**a)** AOI = 0°  
**b)** AOI = 45°, unpolarized light



**Figure 4:** Silver mirror with enhanced reflectance at 425 and 850 nm ( $R > 99.5\%$ )

## Turning Mirrors for 1030 nm



**Figure 5:** Silver based turning mirror with enhanced reflectance for 45°, 1030 nm and  $R > 80\%$  for any alignment laser in the red spectral range

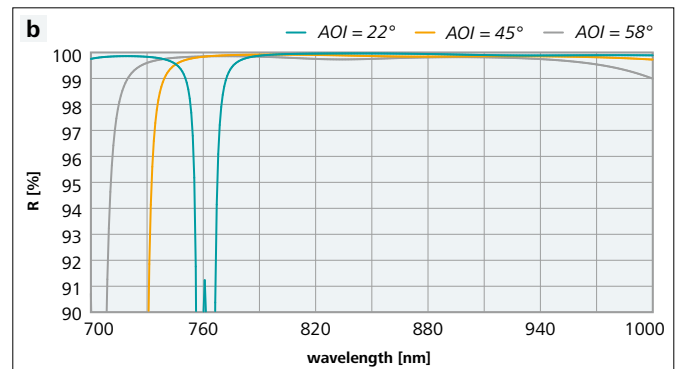
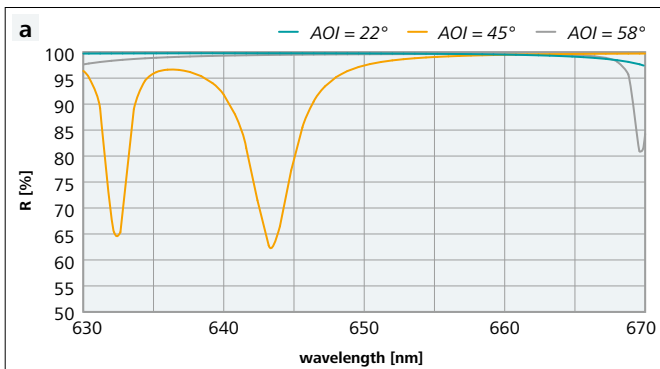
The mirror in figure 5 is a cost-effective alternative for all dielectric mirrors for high power Yb:YAG or Nd:YAG lasers.

### LIDT Info

50 kW/cm<sup>2</sup>, wavelength: 1030 nm, cw

tested without destruction

## Scanning Mirrors

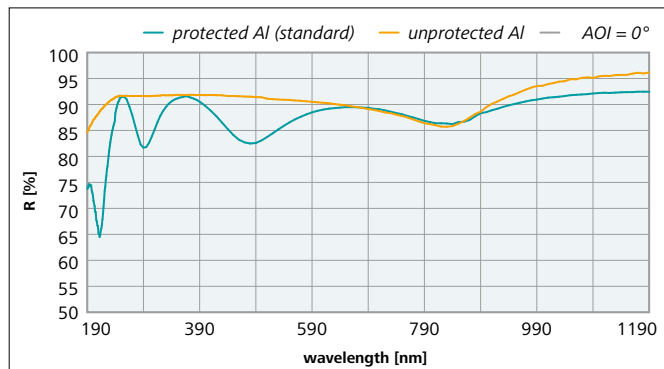


**Figure 6:** Reflectance spectra of a dielectrically enhanced silver mirror which can be used as scanning mirror for laser diodes in the NIR:  
HRu (22° – 58°, 805 – 940 nm) > 99.3 %  
+ Ru (22° – 58°, 630 – 670 nm) > 50 %

For more information on enhanced silver mirrors see page 18, 52 f. and 76 f.

# Front Surface Aluminum Mirrors (150 – 900 nm)

## Broadband Mirrors for the UV, VIS and NIR



**Figure 1:** Reflectance spectra of unprotected aluminum and of a standard protected aluminum mirror

### Optical Properties

Unprotected aluminum:

- $R > 80\%$  at 193 nm
- $R = 92\%$  at 248 nm
- $R > 85\%$  from 200 nm to 950 nm
- $R > 90\%$  from 230 nm to 600 nm
- $R > 90\%$  for  $\lambda > 1\ \mu\text{m}$

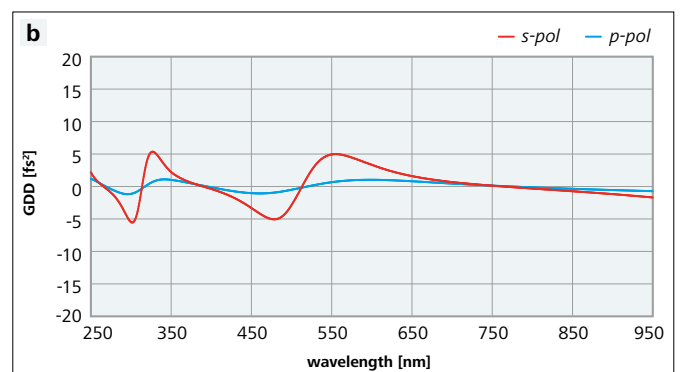
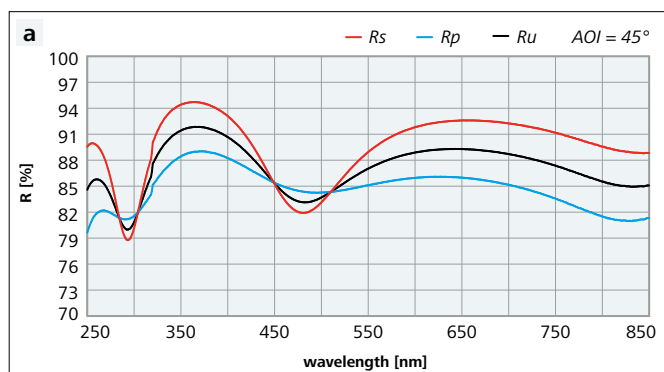
Standard mirror:

- $R = 82 \dots 92\%$  from 240 nm to 550 nm
- $R = 85 \dots 92\%$  from 550 nm to 950 nm
- $R > 92\%$  for  $\lambda > 1\ \mu\text{m}$

Aluminum is the metal with the highest reflectance in the UV spectral range. Besides this, aluminum has a high and relatively constant reflectance in the VIS and NIR. The minimum in the reflectance curve around 800 nm is due to a phonon resonance and can only be overcome by a dielectric protective coating. The reflectance in the VIS and UV spectral range can be influenced by the coating technologies. In case of protected aluminum mirrors, the positions of the minima and maxima of the reflectance depend on the design of the protective layer system and on the angle of incidence (AOI). Please specify AOI and the wavelengths of interest so that reflectance may be optimized as much as possible.

Maximum diameter: 600 mm, especially for astronomical applications.

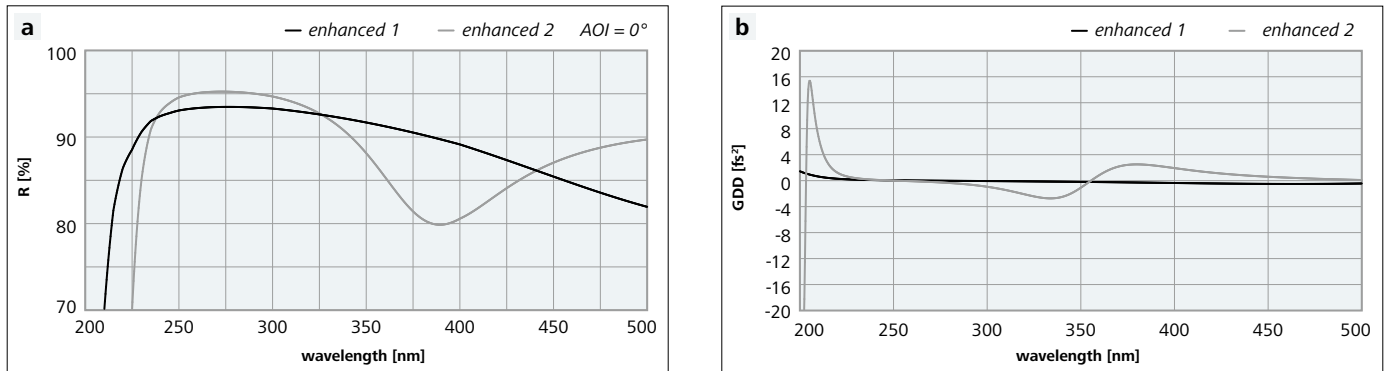
## Aluminum Mirrors for Multiple Wavelength and Ultrafast Applications



**Figure 2:** Reflectance and GDD spectra of an aluminum mirror optimized for  $R > 85\%$  at 266 nm, 400 nm and 800 nm (AOI = 45°)

- Reflectance vs. wavelength
- GDD vs. wavelength

Figure 2 shows the reflectance spectra of a mirror optimized for high reflectance at 266 nm, 400 nm and 800 nm at AOI = 45°.



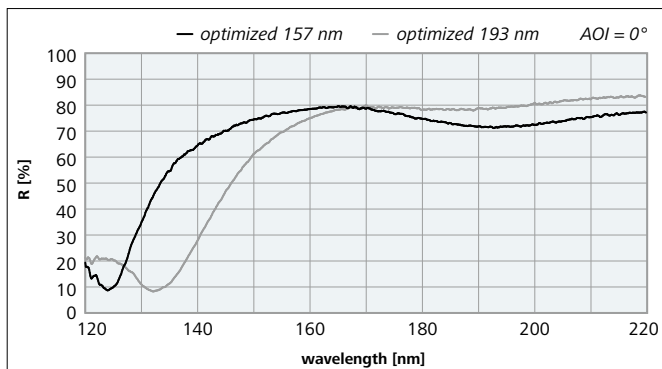
**Figure 3:** Reflectance and GDD spectra of aluminum mirrors with different designs for enhanced reflectance for the third harmonic of the Ti:Sapphire laser (AOI = 0°)

- a) Reflectance vs. wavelength
- b) GDD vs. wavelength

### Special Features

- High reflectance in the wavelength range specified
- Extremely low scattering losses of protected aluminum mirrors (total scattering TS < 100 ppm at 633 nm, TS < 1000 ppm at 248 nm, TS < 5000 ppm at 193 nm)
- Standard mirrors can be cleaned using ethanol or acetone and are resistant to moderate abrasion (tested according to MIL-M-48497A § 4.5.4.2 and § 4.5.3.3)
- All mirrors are resistant to humidity (tested according to MIL-M-13508C §4.4.7)
- Highly stable optical parameters because of sputtered SiO<sub>2</sub> protective layer

### Protected Aluminum Mirrors for the DUV and VUV



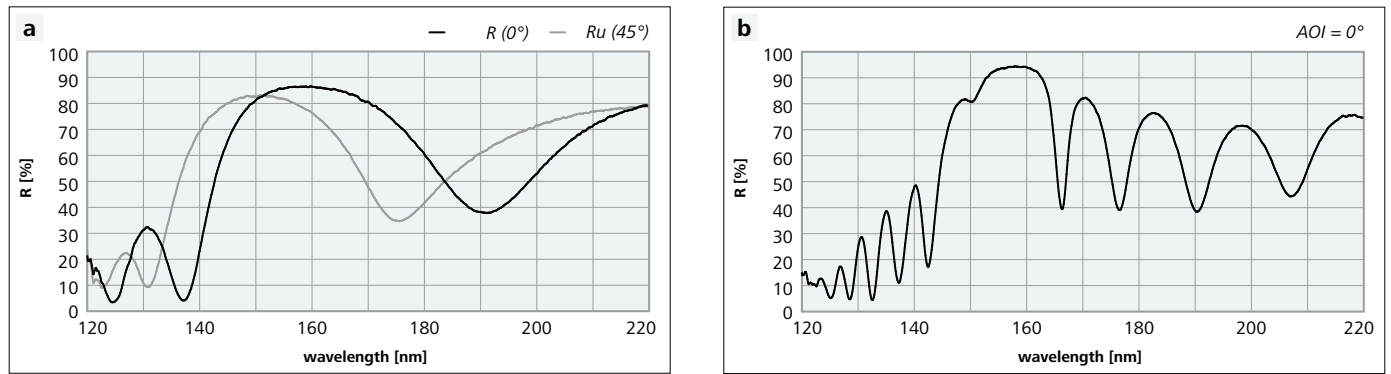
**Figure 4:** UV optimized aluminum: reflectance spectra of aluminum mirrors optimized for 157 nm and 193 nm (AOI = 0°)

### Optical Properties

Special coating design depending on the wavelengths of interest:

- Optimized for 157 nm: R = 74 ... 78 % for 157 nm (R > 70 % from 150 to 200 nm)
- Optimized for 193 nm: R = 75 ... 80 % for 193 nm
- Optimized for 248 nm: R > 90 % for 248 nm

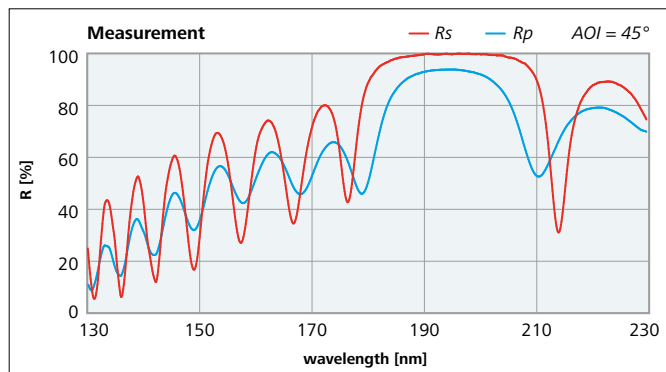
**Enhanced Aluminum Mirrors for 157 nm**



**Figure 5:** Reflectance spectra of two types of enhanced aluminum mirrors for 157 nm:  
**a)**  $R > 80\%$  for  $AOI = 0^\circ \dots 45^\circ$   
**b)**  $R > 94\%$  at  $AOI = 0^\circ$

- Reflectance at 157 nm can be further improved by dielectric protective coatings (up to  $R > 94\%$ )
- Reflectance in the VIS:  $R = 60 \dots 80\%$ . This can be used for an alignment laser
- Especially mirrors with  $R = 85 \dots 90\%$  can be used at a wider range of AOI than all dielectric mirrors of this reflectance

**Enhanced Aluminum Mirrors for 193 nm**



**Figure 6:** Reflectance spectra of an aluminum mirror with enhanced reflectance for 193 nm ( $AOI = 45^\circ$ ,  $R_u > 95\%$ )

- Reflectance at 193 nm can be improved up to  $R_u > 95\%$
- This kind of mirrors can also be used as scanning mirror for  $AOI = 45^\circ - 50^\circ$  with  $R_u > 93\%$
- Reflectance in the VIS:  $R = 60 \dots 80\%$ . This can be used for an alignment laser
- VUV optimized mirrors should be treated with extreme care

## Special Metallic Coatings (400 – 10 000 nm)

### Chromium Coatings for Optical Applications

Chromium coatings are used for lithographic processes and other special optical applications. LAYERTEC offers chromium coatings with extremely low pinhole density on mask blanks and silicon wafers. Typical substrates sizes are 6 inch × 6 inch, but uncommon sizes up to diameter 600 mm are also possible. LAYERTEC uses specialized sputtering processes for very efficient industrial production. These processes are optimized for:

- Low pinhole density
- High optical density
- Low mechanical stress
- High electrical conductivity

Besides high volume coating manufacturing, LAYERTEC still maintains its capabilities for flexible production of small volumes such as OEM components or components for research and development. Do not hesitate to contact LAYERTEC regarding your special request.

### Broadband Neutral Density Filters for the NIR

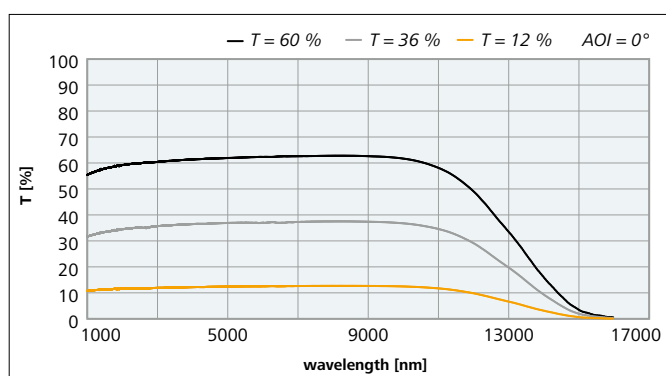


Figure 1: Transmittance spectra of broadband neutral density filters with different transmittance values

- Nearly constant transmittance for broad wavelength range from 1  $\mu\text{m}$  to 10  $\mu\text{m}$
- Substrate:  $\text{BaF}_2$
- Other transmittance values on request

### Solderable Coatings

Soldering is one of the most important mounting techniques for optics which require excellent thermal contact to a heat sink. LAYERTEC has developed several coating designs containing gold and other metals which can be used for soldering of the optics. A very special problem is to solder coatings on components for high power applications. As an example figure 2 show a pump mirror which is coated with a solder layer system on the top side and with dielectric coatings on the front and rear surfaces. Extreme care must be taken to avoid metallic contaminations on the optical surfaces. Nevertheless, the solder coating has to cover the whole top surface of the substrate.

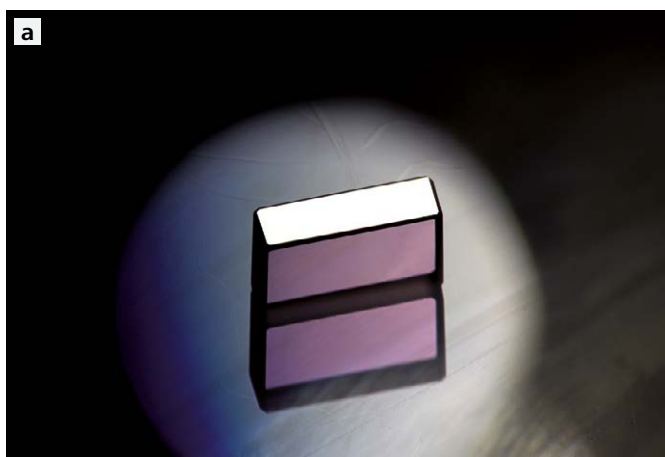


Figure 2: Pump mirror which is coated with a solderable layer on the top side

## Gold Mirrors for the NIR Spectral Range

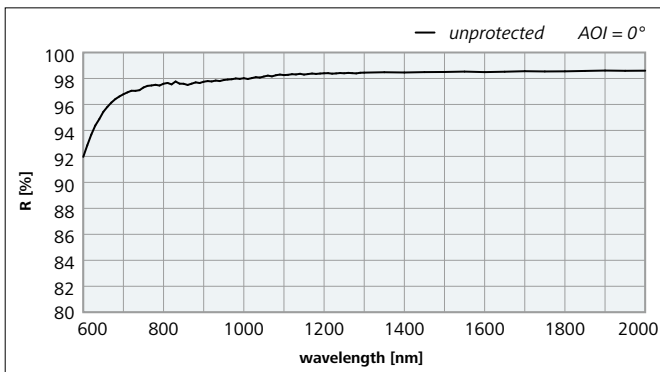


Figure 3: Reflectance spectrum of an unprotected gold mirror



Figure 4: Gold mirror on plano-concave substrate

### Optical Properties

Unprotected gold:

- $R > 97\%$  from 700 nm to 1  $\mu\text{m}$
- $R > 98\%$  for  $\lambda > 1\ \mu\text{m}$  to 20  $\mu\text{m}$

### Special Features

- Extremely low scattering losses (total scattering TS < 100 ppm at 633 nm)
- Gold mirrors are chemically stable and can be used without protective layer
- Unprotected gold is soft and scratches easily
- Protected mirrors can be cleaned (tested according to MIL-M-13508C § 4.4.5)

## Partially Transmissive Gold Layers for Optical and Non-optical Applications

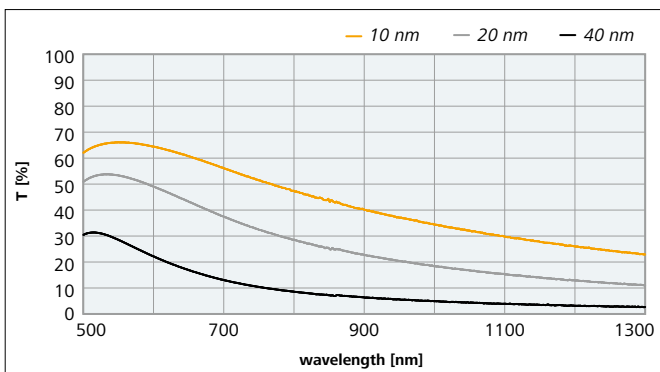


Figure 5: Transmittance of partially transparent gold coatings on sapphire

Gold coatings with a thickness of 10 nm to 50 nm can be used as partial reflectors or attenuators in the NIR spectral range. Figure 5 shows transmittance spectra of gold layers with different thickness. Moreover, thin gold layers are also useful for non-optical applications. An example of such an application is the generation of single electron pulses. Thin metallic layers are irradiated with femto-second laser pulses. This results in the release of electrons. These electron pulses are generated with the repetition rate of the ultrafast laser. The pulse length of these electron pulses can be compressed to the attosecond range using a microwave cavity [1, 2]. Magnetron sputtering allows the manufacture of partially transmissive gold layers in the mentioned thickness range. The optical parameters of these coatings are very stable because gold is chemically inert. Please note that gold layers are soft and can be easily damaged mechanically.

### Literature

[1] A. Gliserin, A. Apolonski, F. Krausz, P. Baum: "Compression of single electron pulses with a microwave cavity"; New Journal of Physics 14(2012) 073055 (18 pp)

[2] M. Aidelsburger, F. O. Kirchner, F. Krausz and P. Baum: "Single-electron pulses for ultrafast diffraction"; PNAS Vol.107, No.46, pages 19714-19719



# Standard Items from Stock

## Chapter Index

<b>The LAYERTEC Standard Items .....</b>	<b>97</b>	<b>cw/ns-Laser [1030–1064 nm].....</b>	<b>117</b>
<b>Specifications of Plane Substrates.....</b>	<b>98</b>	Laser Mirror 0° .....	117
<b>Specifications of Curved Substrates .....</b>	<b>100</b>	Pump Mirror 0° .....	117
<b>Excimer Lasers [193 nm, 248 nm, 308 nm] .....</b>	<b>102</b>	Turning Mirror 22.5–45°, 1 030–1 064 nm .....	118
Turning Mirror 45°, 193 nm .....	102	Turning Mirror 22.5–45°, 515–532 nm .....	118
Turning Mirror 45°, 248 nm .....	102	Turning Mirror 45°, 1 030–1 064 nm .....	118
Turning Mirror 45°, 308 nm .....	102	Turning Mirror 45°, 515–532 nm .....	118
Window 0°, 193 nm .....	102	Turning Mirror 45°, 343+515+1 030 nm .....	118
Window 0°, 248 nm .....	103	Turning Mirror 45°, 355+532+1 064 nm .....	119
Window 0°, 308 nm .....	103	Non-Polarizing Beamsplitter 45°, 1 030 nm .....	119
<b>fs-Laser [TiSa, up to 150 nm bandwidth].....</b>	<b>104</b>	Non-Polarizing Beamsplitter 45°, 1 064 nm .....	119
Laser Mirror 0° .....	104	Non-Polarizing Beamsplitter 45°, 515 nm .....	119
Laser Mirror 0°, high power .....	104	Non-Polarizing Beamsplitter 45°, 532 nm .....	120
Pump Mirror 5° .....	105	Separator 45°, 515–532/1 030–1 064 nm .....	120
Turning Mirror 22.5° .....	105	Separator 45°, 1 030/515 nm .....	120
Turning Mirror 45° .....	105	Separator 45°, 1 064/532 nm .....	120
Turning Mirror 45°, p-pol. ....	105	Separator 45°, p-pol. 343/515/1 030 nm .....	121
Turning Mirror 45°, high power .....	106	Separator 45°, p-pol. 355/532/1 064 nm .....	121
Separator 0°, 750–850/360–450 nm .....	106	Separator 45°, s-pol. 343–355/515–532/1 030–1 064 nm .....	121
Separator 45°, 760–850/350–450 nm .....	106	Thin Film Polarizer 56°, 1 030 nm .....	122
Laser Mirror 0–45° .....	106	Thin Film Polarizer 56°, 1 064 nm .....	122
Chirped Mirror 5° .....	107	Thin Film Polarizer 56°, 515 nm .....	122
Chirped Mirror Pair 5°, -40 fs <sup>2</sup> .....	107	Thin Film Polarizer 56°, 532 nm .....	122
Chirped Mirror Pair 5°, -80 fs <sup>2</sup> .....	107	Window 0° .....	122
Chirped Mirror Pair 5°, -110 fs <sup>2</sup> .....	107	<b>2 μm [Ho:YAG Tm:YAG].....</b>	<b>123</b>
Beamsplitter 45°, s-pol. ....	108	Turning Mirror 45° .....	123
Beamsplitter 45°, p-pol. ....	108	Output Coupler 70 % .....	123
Window 0° .....	108	Output Coupler 80 % .....	123
<b>fs-Laser [TiSa, 300 nm bandwidth].....</b>	<b>109</b>	Output Coupler 95 % .....	124
Laser Mirror 0° .....	109	GTI-Mirror 5°, -500 fs <sup>2</sup> .....	124
Pump Mirror Pair 0° .....	109	Short Wave Pass Filter 45° .....	124
Turning Mirror 22.5° .....	110	Thin Film Polarizer 55° .....	124
Turning Mirror 45°, p-pol. ....	110	<b>3 μm [Er:YAG] .....</b>	<b>125</b>
Turning Mirror 45°, s-pol. ....	110	Laser Mirror 0°, high power .....	125
Turning Mirror 45° .....	110	Output Coupler 80 % .....	125
Laser Mirror 0–45° .....	111	Output Coupler 85 % .....	125
Chirped Mirror Pair 5° .....	111	Output Coupler 90 % .....	126
Beamsplitter 45°, p-pol. ....	111	Turning Mirror 45°, Red R > 95% .....	126
Beamsplitter 45°, s-pol. ....	112	Turning Mirror 45°, Red R < 20% .....	126
Polarizer 75° .....	112	<b>Metallic Mirrors.....</b>	<b>127</b>
Window 0° .....	112	Unprotected Gold Mirror .....	127
<b>ps/fs-Laser [1030–1040 nm].....</b>	<b>113</b>	Protected Gold Mirror .....	127
Laser Mirror 0° .....	113	Protected Silver Mirror, 600–1000 nm .....	127
Pump Mirror 0°, 800–982 nm .....	113	Protected Silver Mirror, 800–2 000 nm .....	128
Pump Mirror 0°, 960–982 nm .....	114	Protected Aluminum Mirror, UV-range .....	128
Turning Mirror 45° .....	114	Protected Aluminum Mirror, UV-VIS-range .....	128
GTI-Mirror 5°, 1 030 nm, -250 fs <sup>2</sup> .....	114	<b>Low Loss Mirrors for CRD-Measurements .....</b>	<b>129</b>
GTI-Mirror 5°, 1 030 nm, -550 fs <sup>2</sup> .....	114	Principal Curves of Reflectance and Transmittance.....	129
GTI-Mirror 5°, 1 030 nm, -1 000 fs <sup>2</sup> .....	115	<b>Low Loss Mirror Set for High Finesse Cavities .....</b>	<b>130</b>
GTI-Mirror 5°, 1 040 nm, -250 fs <sup>2</sup> .....	115	Plane/ Plane Substrate.....	130
GTI-Mirror 5°, 1 040 nm, -550 fs <sup>2</sup> .....	115	CC 1 000/ Plane Substrate .....	130
GTI-Mirror 5°, 1 040 nm, -1 000 fs <sup>2</sup> .....	115	<b>Beam Expanders .....</b>	<b>132</b>
Separator 22.5° .....	116	Lenses 0°, 800 nm .....	132
Thin Film Polarizer 45°, 1 030 nm .....	116	Lenses 0°, 1 000 nm .....	132
Thin Film Polarizer 45°, 1 042 nm .....	116		
Thin Film Polarizer 56°, 1 030 nm .....	116		
Thin Film Polarizer 56°, 1 042 nm .....	116		
Window 0° .....	116		



# Standard Items from Stock

The LAYERTEC Standard Items are kept in stock for you and will be shipped by return. You can order the components through our webshop at [www.layertec.de](http://www.layertec.de) or by e-mail.

Please do not hesitate to contact us for a quotation or a discussion regarding your special requirements, especially if they are not mentioned in this catalog. We are looking forward to complex tasks. Simply contact us at [info@layertec.de](mailto:info@layertec.de).

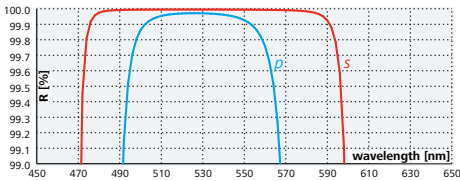
## How to Order

### 1. Choose type of laser

### 2. Choose optical element / coating

#### Turning Mirror 45°, 515–532nm

coating 141329  
HR<sub>s,p</sub> (45°, 515–532 nm) > 99.9%



### 3. Choose size and shape of substrate on page 98 ff

### 4. Order online at [www.layertec.de](http://www.layertec.de)



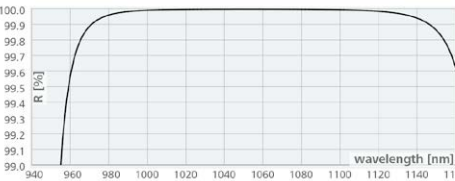
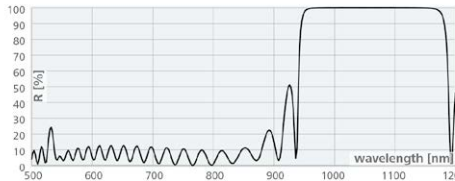
## LAYERTEC Item Numbers

To order an optical component, you need the item number. Please note, that the item number is not identical with the coating number.

### Example: 1 coating number 141321 applied on 3 different substrates

**Laser Mirror 0°**  
**Coating 141321**  
HR<sub>s,p</sub> (0–10°, 1030–1064 nm) > 99.95%

←..... Coating number

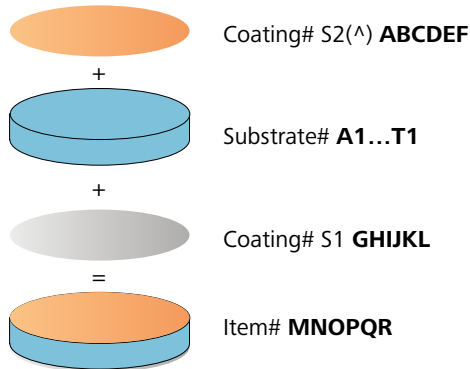


LIDT  
6/ 50J/cm<sup>2</sup>; 1064 nm; 7 ns; Ø270µm LAYERTEC

Substrate Dimensions	No.	Imperfections	Item #	Price
Ø 12.7 mm   t 6.35 mm	A4	5/ 1 x 0.04	141864	86 €
Ø 25.0 mm   t 6.35 mm	B4	5/ 3 x 0.04	141868	119 €
Ø 50.0 mm   t 9.5 mm	C3	5/ 4 x 0.063	141866	435 €

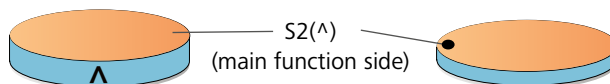
←..... Item number

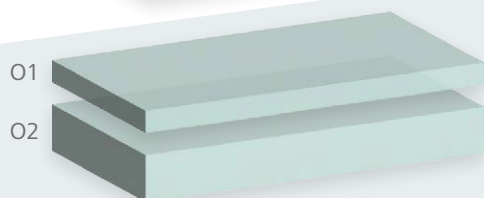
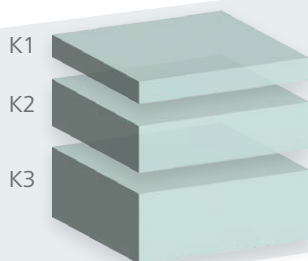
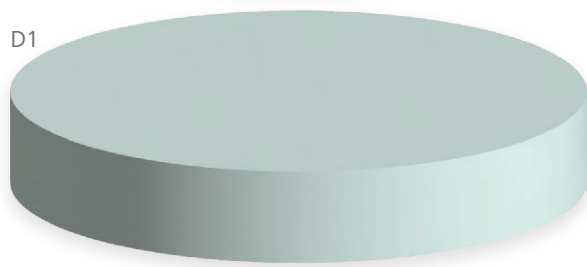
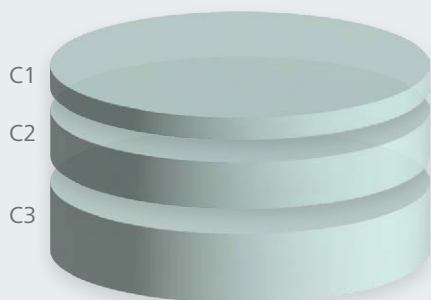
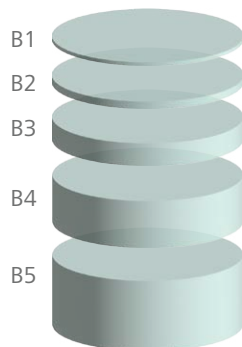
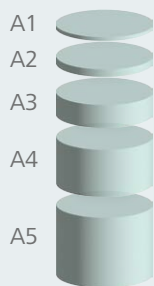
### How LAYERTEC item numbers are generated



### Main Function Side: S2(^)

LAYERTEC marks the main function side either with an arrow or a dot (items thinner than 1 mm). On items with edge thickness above 1 mm, also the coating batch is included. For all fused silica substrates, laser engraving is used.





No.	Material	Length / Diameter	Thickness
<b>A1</b>	Fused Silica	Ø 12.7 mm (-0.1 mm)	0.5 mm (±0.1 mm)
<b>A2</b>	Fused Silica	Ø 12.7 mm (-0.1 mm)	1.0 mm (±0.1 mm)
<b>A3</b>	Fused Silica	Ø 12.7 mm (-0.1 mm)	3.05 mm (±0.1 mm)
<b>A3 e</b>	Sapphire	Ø 12.7 mm (-0.1 mm)	3.0 mm (±0.1 mm)
<b>A4</b>	Fused Silica	Ø 12.7 mm (-0.1 mm)	6.35 mm (±0.1 mm)
<b>A4b</b>	Fused Silica (IR grade)	Ø 12.7 mm (-0.1 mm)	6.35 mm (±0.1 mm)
<b>A5</b>	Fused Silica	Ø 12.7 mm (-0.1 mm)	9.5 mm (±0.2 mm)

<b>B1</b>	Fused Silica	Ø 25.0 mm (-0.1 mm)	0.5 mm (±0.1 mm)
<b>B2</b>	Fused Silica	Ø 25.0 mm (-0.1 mm)	1.0 mm (±0.1 mm)
<b>B3</b>	Fused Silica	Ø 25.0 mm (-0.1 mm)	3.05 mm (±0.1 mm)
<b>B3b</b>	Fused Silica (IR grade)	Ø 25.0 mm (-0.1 mm)	3.0 mm (±0.1 mm)
<b>B3c</b>	Fused Silica (248 nm grade)	Ø 25.0 mm (-0.1 mm)	3.05 mm (±0.1 mm)
<b>B3d</b>	Fused Silica (193 nm grade)	Ø 25.0 mm (-0.1 mm)	3.0 mm (±0.1 mm)
<b>B3e</b>	Sapphire	Ø 25.4 mm (-0.1 mm)	3.0 mm (±0.1 mm)
<b>B3f</b>	CaF <sub>2</sub> (193 nm grade)	Ø 25.0 mm (-0.1 mm)	3.0 mm (±0.1 mm)
<b>B4</b>	Fused Silica	Ø 25.0 mm (-0.1 mm)	6.35 mm (±0.1 mm)
<b>B4b</b>	Fused Silica (IR grade)	Ø 25.0 mm (-0.1 mm)	6.35 mm (±0.1 mm)
<b>B4f</b>	CaF <sub>2</sub> (UV grade)	Ø 25.0 mm (-0.1 mm)	6.35 mm (±0.1 mm)
<b>B4g</b>	Fused Silica	Ø 25.0 mm (-0.1 mm)	6.35 mm (±0.1 mm)
<b>B4h</b>	ULE	Ø 25.0 mm (-0.1 mm)	6.35 mm (±0.1 mm)
<b>B5</b>	Fused Silica	Ø 25.0 mm (-0.1 mm)	9.5 mm (±0.2 mm)

<b>C1</b>	Fused Silica	Ø 50.0 mm (-0.1 mm)	3.05 mm (±0.1 mm)
<b>C1f</b>	CaF <sub>2</sub> (UV grade)	Ø 50.0 mm (-0.1 mm)	5.0 mm (±0.1 mm)
<b>C2</b>	Fused Silica	Ø 50.0 mm (-0.1 mm)	6.35 mm (±0.1 mm)
<b>C3</b>	Fused Silica	Ø 50.0 mm (-0.1 mm)	9.5 mm (±0.2 mm)

<b>D1</b>	Fused Silica	Ø 76.2 mm (-0.1 mm)	12.5 mm (±0.2 mm)
-----------	--------------	---------------------	-------------------

<b>K1</b>	Fused Silica	25×25 mm <sup>2</sup> (-0.1 mm)	3.05 mm (±0.1 mm)
<b>K2</b>	Fused Silica	25×25 mm <sup>2</sup> (-0.1 mm)	6.35 mm (±0.1 mm)
<b>K3</b>	Fused Silica	25×25 mm <sup>2</sup> (-0.1 mm)	9.5 mm (±0.2 mm)

<b>N1</b>	Fused Silica	40×10 mm <sup>2</sup> (-0.1 mm)	12.5 mm (±0.2 mm)
-----------	--------------	---------------------------------	-------------------

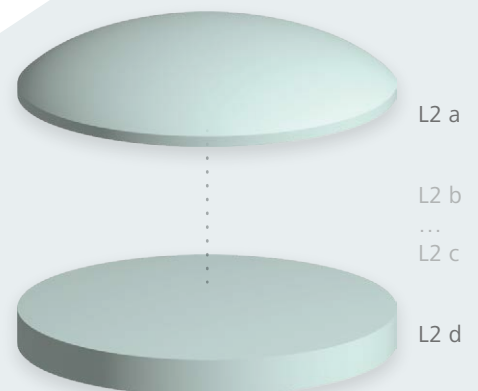
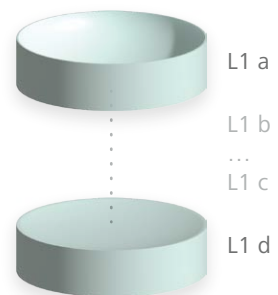
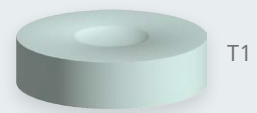
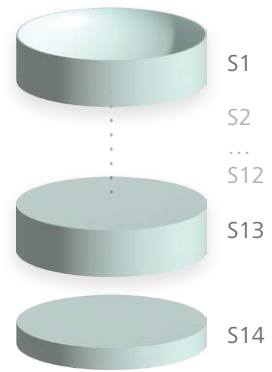
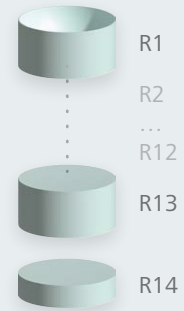
<b>O1f</b>	CaF <sub>2</sub> (UV grade)	50×27 mm <sup>2</sup> (-0.1 mm)	3.0 mm (±0.1 mm)
<b>O2</b>	Fused Silica	50×27 mm <sup>2</sup> (-0.1 mm)	6.35 mm (±0.1 mm)

	S1	S1	S2	//	Clear Aperture Øe	Uncoated Surface Form Tolerance with $\lambda = 546 \text{ nm}$			No.
	plane	plane	plane	< 5'	10mm	3 / 137 nm (55 nm)	3 / 0.5 (0.2)	$\lambda/10$ reg.	<b>A1</b>
3 / 137 nm (55 nm)						3 / 0.5 (0.2)	$\lambda/10$ reg.	<b>A2</b>	
3 / 55 nm (55 nm)						3 / 0.2 (0.2)	$\lambda/10$	<b>A3</b>	
3 / 247 nm (247 nm)						3 / 1 (1)	$\lambda/2$	<b>A3 e</b>	
3 / 55 nm (55 nm)						3 / 0.2 (0.2)	$\lambda/10$	<b>A4</b>	
3 / 55 nm (55 nm)						3 / 0.2 (0.2)	$\lambda/10$	<b>A4 b</b>	
3 / 55 nm (55 nm)						3 / 0.2 (0.2)	$\lambda/10$	<b>A5</b>	
	plane	plane	plane	< 5'	20mm	3 / 137 nm (55 nm)	3 / 0.5 (0.2)	$\lambda/10$ reg.	<b>B1</b>
3 / 137 nm (55 nm)						3 / 0.5 (0.2)	$\lambda/10$ reg.	<b>B2</b>	
3 / 137 nm (55 nm)						3 / 0.5 (0.2)	$\lambda/10$ reg.	<b>B3</b>	
3 / 137 nm (55 nm)						3 / 0.5 (0.2)	$\lambda/10$ reg.	<b>B3 b</b>	
3 / 137 nm (55 nm)						3 / 0.5 (0.2)	$\lambda/10$ reg.	<b>B3 c</b>	
3 / 137 nm (55 nm)						3 / 0.5 (0.2)	$\lambda/10$ reg.	<b>B3 d</b>	
3 / 247 nm (247 nm)						3 / 1 (1)	$\lambda/2$	<b>B3 e</b>	
3 / 137 nm (55 nm)						3 / 0.5 (0.2)	$\lambda/10$ reg.	<b>B3 f</b>	
3 / 55 nm (55 nm)						3 / 0.2 (0.2)	$\lambda/10$	<b>B4</b>	
3 / 55 nm (55 nm)						3 / 0.2 (0.2)	$\lambda/10$	<b>B4 b</b>	
3 / 55 nm (55 nm)						3 / 0.2 (0.2)	$\lambda/10$	<b>B4 f</b>	
see page 130					3 / 55 nm (55 nm)	3 / 0.2 (0.2)	$\lambda/10$	<b>B4 g</b>	
see page 130					3 / 55 nm (55 nm)	3 / 0.2 (0.2)	$\lambda/10$	<b>B4 h</b>	
20mm					3 / 55 nm (55 nm)	3 / 0.2 (0.2)	$\lambda/10$	<b>B5</b>	
	plane	plane	plane	< 5'	25mm	3 / 137 nm (55 nm)	3 / 0.5 (0.2)	$\lambda/10$ reg.	<b>C1</b>
40mm					3 / 137 nm (137 nm)	3 / 0.5 (0.2)	$\lambda/4$	<b>C1 f</b>	
30mm					3 / 137 nm (55 nm)	3 / 0.5 (0.2)	$\lambda/10$ reg.	<b>C2</b>	
40mm					3 / 55 nm (55 nm)	3 / 0.2 (0.2)	$\lambda/10$	<b>C3</b>	
	plane	plane	plane	< 5'	60mm	3 / 55 nm (55 nm)	3 / 0.2 (0.2)	$\lambda/10$	<b>D1</b>
	plane	plane	plane	< 5'	20mm	3 / 137 nm (55 nm)	3 / 0.5 (0.2)	$\lambda/10$ reg.	<b>K1</b>
3 / 55 nm (55 nm)						3 / 0.2 (0.2)	$\lambda/10$	<b>K2</b>	
3 / 55 nm (55 nm)						3 / 0.2 (0.2)	$\lambda/10$	<b>K3</b>	
	plane	plane	plane	< 5'	32×8mm <sup>2</sup>	3 / 55 nm (55 nm)	3 / 0.2 (0.2)	$\lambda/10$	<b>N1</b>
	plane	plane	plane	< 5'	42×23mm <sup>2</sup>	3 / 1100 nm (1100 nm)	3 / 4 (4)	2 $\lambda$	<b>O1 f</b>
3 / 55 nm (55 nm)						3 / 0.2 (0.2)	$\lambda/10$	<b>O2</b>	

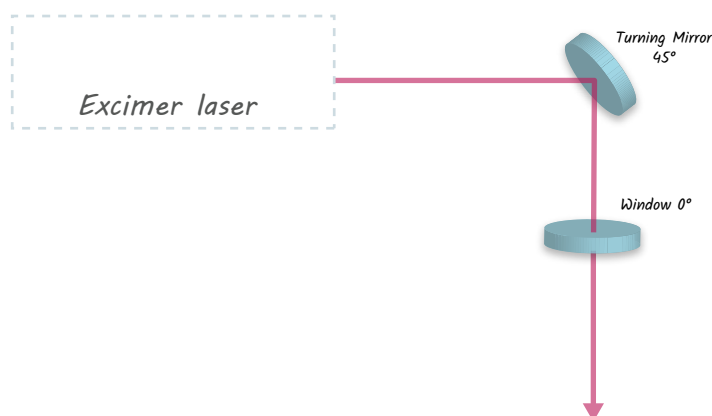
**Standard Items from Stock**  
Specifications of Curved Substrates

No.	Uncoated Surface Form Tolerance with $\lambda = 546 \text{ nm}$			Clear Aperture $\varnothing e$	//	S2	S1
R1	3 / - (55 nm)	3 / - (0.2)	$\lambda/10$ reg.	10 mm	< 5'	CC (concave)	plane
R2							
R3							
R4							
R5							
R6							
R7							
R8							
R9							
R10							
R11							
R12							
R13							
R14							
S1	3 / - (55 nm)	3 / - (0.2)	$\lambda/10$ reg.	20 mm	< 5'	CC (concave)	plane
S2							
S3							
S4							
S5							
S6							
S7							
S8							
S9							
S10							
S11							
S12							
S13							
S14							
T1a	3 / - (55 nm)	3 / - (0.2)	$\lambda/10$ reg.	see page 130	< 5'	CC (concave)	plane
T1b							
L1a	3 / - (55 nm)	3 / - (0.2)	$\lambda/10$ reg.	15 mm	centr. < 4'	CC (concave)	plane
L1b							
L1c							
L1d							
L2a	3 / - (55 nm)	3 / - (0.2)	$\lambda/10$ reg.	30 mm	centr. < 4'	CX (convex)	plane
L2b							
L2c							
L2d							

	ROC	Length / Diameter	Thickness	Material	No.
	25 mm (±0.5 %)	Ø 12.7 mm (- 0.1 mm)	6.35 mm (±0.1 mm)	Fused Silica	<b>R1</b>
	38 mm (±0.5 %)				<b>R2</b>
	50 mm (±0.5 %)				<b>R3</b>
	75 mm (±0.5 %)				<b>R4</b>
	100 mm (±0.5 %)				<b>R5</b>
	125 mm (±0.5 %)				<b>R6</b>
	150 mm (±0.5 %)				<b>R7</b>
	200 mm (±0.5 %)				<b>R8</b>
	250 mm (±0.5 %)				<b>R9</b>
	300 mm (±0.5 %)				<b>R10</b>
	500 mm (±0.5 %)				<b>R11</b>
	750 mm (±1.0 %)				<b>R12</b>
	1000 mm (±1.0 %)				<b>R13</b>
	1000 mm (±1.0 %)		3.0 mm (±0.1 mm)	YAG	<b>R14</b>
	25 mm (±0.5 %)	Ø 25.0 mm (- 0.1 mm)	6.35 mm (±0.1 mm)	Fused Silica	<b>S1</b>
	38 mm (±0.5 %)				<b>S2</b>
	50 mm (±0.5 %)				<b>S3</b>
	75 mm (±0.5 %)				<b>S4</b>
	100 mm (±0.5 %)				<b>S5</b>
	125 mm (±0.5 %)				<b>S6</b>
	150 mm (±0.5 %)				<b>S7</b>
	200 mm (±0.5 %)				<b>S8</b>
	250 mm (±0.5 %)				<b>S9</b>
	300 mm (±0.5 %)				<b>S10</b>
	500 mm (±0.5 %)				<b>S11</b>
	750 mm (±1.0 %)				<b>S12</b>
	1000 mm (±1.0 %)				<b>S13</b>
	1000 mm (±1.0 %)		3.0 mm (±0.1 mm)	YAG	<b>S14</b>
	1000 mm (±1.0 %)	Ø 25.0 mm (- 0.1 mm)	6.35 mm (±0.1 mm)	Fused Silica	<b>T1 a</b>
				ULE	<b>T1 b</b>
	25 mm (±0.5 %)	Ø 25.0 mm (- 0.1 mm)	6.35 mm (±0.1 mm)	Fused Silica	<b>L1 a</b>
	50 mm (±0.5 %)				<b>L1 b</b>
	75 mm (±0.5 %)				<b>L1 c</b>
	100 mm (±0.5 %)				<b>L1 d</b>
	125 mm (±0.5 %)	Ø 50.0 mm (- 0.1 mm)	6.35 mm (±0.1 mm)	Fused Silica	<b>L2 a</b>
	150 mm (±0.5 %)				<b>L2 b</b>
	175 mm (±0.5 %)				<b>L2 c</b>
	200 mm (±0.5 %)				<b>L2 d</b>



# Excimer Lasers [193 nm, 248 nm, 308 nm]

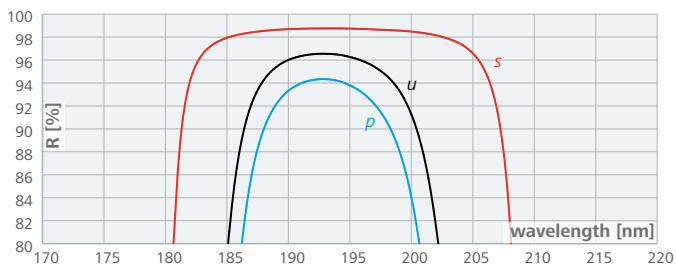


Turning Mirror 45°, 193 nm	102
Turning Mirror 45°, 248 nm	102
Turning Mirror 45°, 308 nm	102
Window 0°, 193 nm	102
Window 0°, 248 nm	103
Window 0°, 308 nm	103

For optics not specified here, please visit [www.layertec.de](http://www.layertec.de), contact us at [info@layertec.de](mailto:info@layertec.de) or call us at +49 (0)36453 744 0.

## Turning Mirror 45°, 193 nm

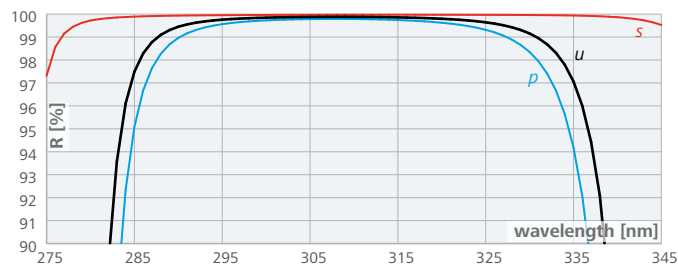
**Coating 113257 on CaF<sub>2</sub> UV-grade**  
**HRu (45°, 193 nm) > 95 %**  
**HRs (45°, 193 nm) > 97 %**  
**HRp (45°, 193 nm) > 93 %**



Substrate Dimensions	No.	Imperfections	Item #	Price
Ø 25.0 mm   t 6.35 mm	B4f	5/ 4 x 0.063	107229	454 €
Ø 50.0 mm   t 5.0 mm	C1f	5/ 5 x 0.063	160821	906 €
50 x 27 mm   t 3.0 mm	O1f	5/ 5 x 0.063	160820	768 €

## Turning Mirror 45°, 308 nm

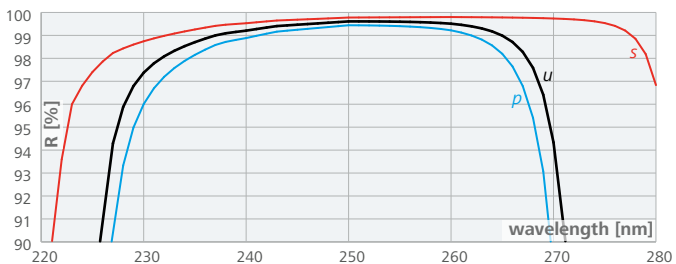
**Coating 159576**  
**HRu (45°, 308 nm) > 99.5 %**  
**HRs (45°, 308 nm) > 99.9 %**  
**HRp (45°, 308 nm) > 99.5 %**



Substrate Dimensions	No.	Imperfections	Item #	Price
Ø 25.0 mm   t 6.35 mm	B4	5/ 2 x 0.04	160801	282 €
Ø 50.0 mm   t 6.35 mm	C2	5/ 3 x 0.063	160802	772 €
50 x 27 mm   t 6.35 mm	O2	5/ 2 x 0.063	160807	585 €

## Turning Mirror 45°, 248 nm

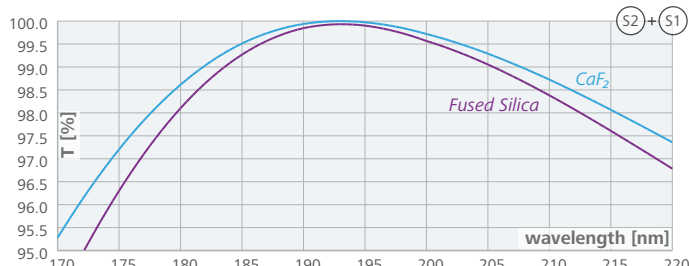
**Coating 159573**  
**HRu (45°, 248 nm) > 99.5 %**  
**HRs (45°, 248 nm) > 99.7 %**  
**HRp (45°, 248 nm) > 99.0 %**



Substrate Dimensions	No.	Imperfections	Item #	Price
Ø 25.0 mm   t 6.35 mm	B4	5/ 2 x 0.04	160804	282 €
Ø 50.0 mm   t 6.35 mm	C2	5/ 3 x 0.063	160803	772 €
50 x 27 mm   t 6.35 mm	O2	5/ 2 x 0.063	160806	585 €

## Window 0°, 193 nm

**S2+S1: Coating 113604 on CaF<sub>2</sub> 193 nm excimer grade**  
**S2+S1: Coating 120805 on Fused Silica 193 nm excimer grade**  
**AR (0°, 193 nm) < 0.25 %**



Substrate Dimensions	No.	Imperfections	Item #	Price
Ø 25.0 mm   t 3.0 mm	B3f	5/ 2 x 0.063	160702	423 €

Coating on CaF<sub>2</sub>

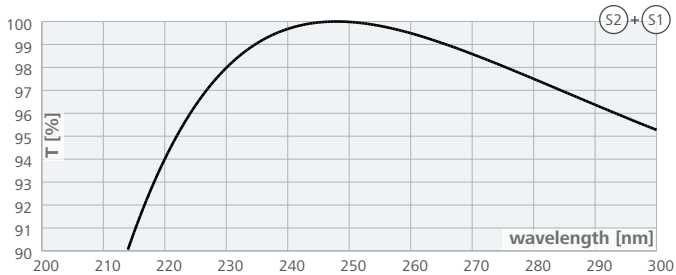
Substrate Dimensions	No.	Imperfections	Item #	Price
Ø 25.0 mm   t 3.0 mm	B3d	5/ 2 x 0.063	160701	300 €

Coating on Fused Silica



**Window 0°, 248 nm**

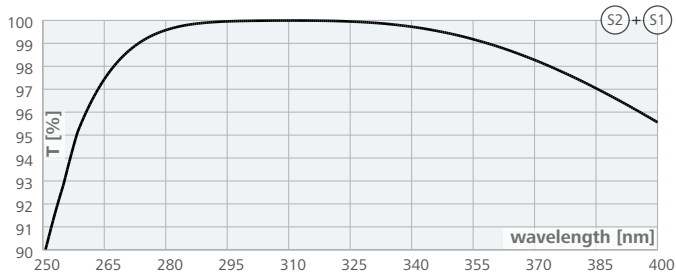
**S2+S1: Coating 127980 on Fused Silica 248 nm excimer grade**  
**AR (0°, 248 nm) < 0.25 %**



Substrate Dimensions	No.	Imperfections	Item #	Price
Ø 25.0 mm   t 3.05 mm	B3 c	5/ 1 x 0.04	160700	264 €

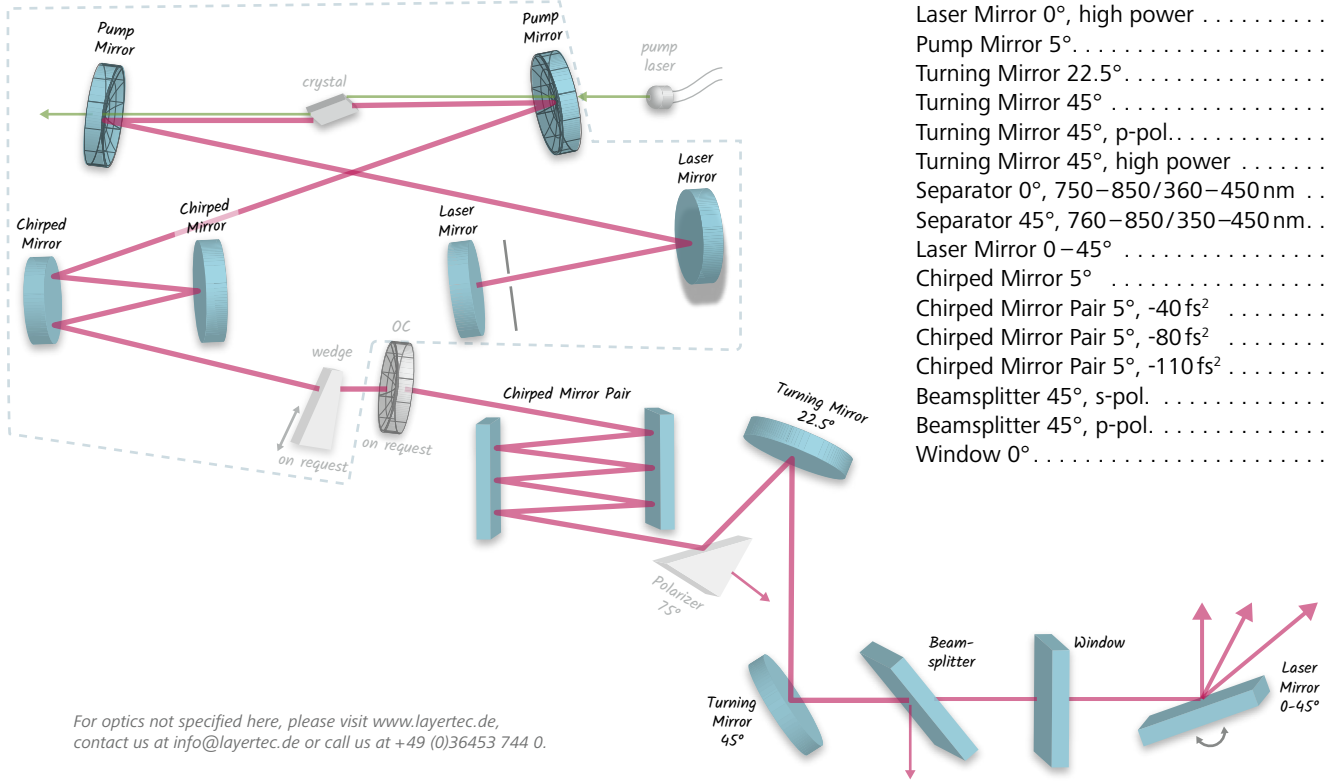
**Window 0°, 308 nm**

**S2+S1: Coating 120555 on Fused Silica 248 nm excimer grade**  
**AR (0°, 308 nm) < 0.25 %**



Substrate Dimensions	No.	Imperfections	Item #	Price
Ø 25.0 mm   t 3.05 mm	B3 c	5/ 1 x 0.04	160699	264 €

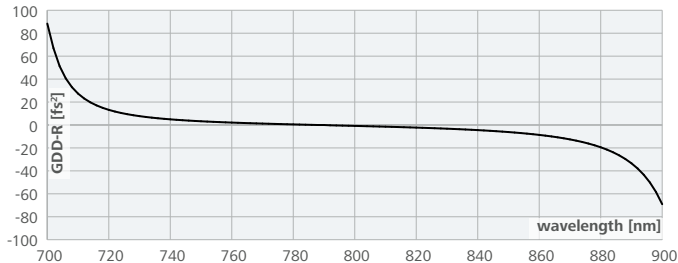
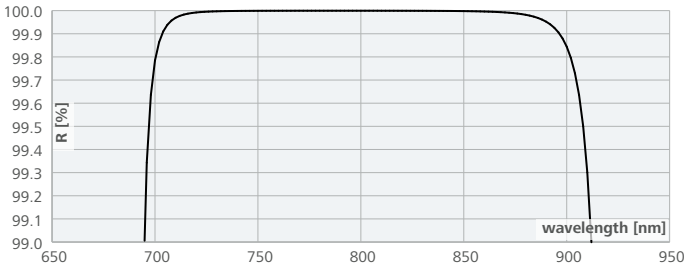
# fs-Laser [TiSa, up to 150 nm bandwidth]



Laser Mirror 0°	104
Laser Mirror 0°, high power	104
Pump Mirror 5°	105
Turning Mirror 22.5°	105
Turning Mirror 45°	105
Turning Mirror 45°, p-pol.	105
Turning Mirror 45°, high power	106
Separator 0°, 750–850/360–450 nm	106
Separator 45°, 760–850/350–450 nm	106
Laser Mirror 0–45°	106
Chirped Mirror 5°	107
Chirped Mirror Pair 5°, -40 fs <sup>2</sup>	107
Chirped Mirror Pair 5°, -80 fs <sup>2</sup>	107
Chirped Mirror Pair 5°, -110 fs <sup>2</sup>	107
Beamsplitter 45°, s-pol.	108
Beamsplitter 45°, p-pol.	108
Window 0°	108

## Laser Mirror 0°

**Coating 139691**  
HRs,p (0–10°, 725–875 nm) > 99.9 %  
|GDD-Rs,p (0–10°, 725–875 nm)| < 50 fs<sup>2</sup>



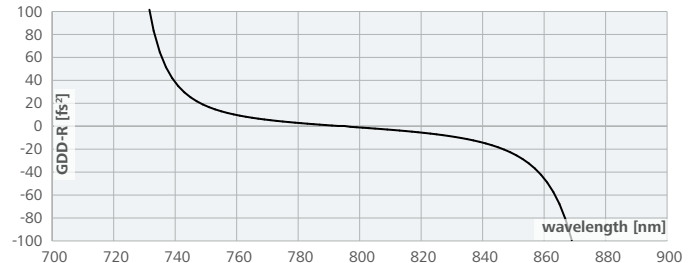
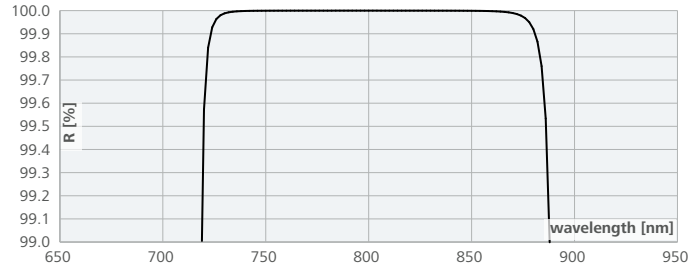
### LIDT

6/ 0.4 J/cm<sup>2</sup>; 800 nm; 40 fs; 1 kHz; Ø 80 µm WRCP Budapest  
6/ 2 J/cm<sup>2</sup>; 800 nm; 70 fs; 10 Hz; Ø 700 µm HZDR Dresden

Substrate Dimensions	No.	Imperfections	Item #	Price
Ø 12.7 mm   t 6.35 mm	A4	5/ 1 x 0.04	140189	100 €
Ø 25.0 mm   t 6.35 mm	B4	5/ 3 x 0.04	140136	138 €
Ø 50.0 mm   t 9.5 mm	C3	5/ 4 x 0.063	140188	468 €

## Laser Mirror 0°, high power

**Coating 140876**  
HRs,p (0–10°, 750–850 nm) > 99.5 %  
|GDD-Rs,p (0–10°, 750–850 nm)| < 60 fs<sup>2</sup>



### LIDT

6/ 1 J/cm<sup>2</sup>; 800 nm; 40 fs; 1 kHz; Ø 80 µm WRCP Budapest  
6/ 2 J/cm<sup>2</sup>; 800 nm; 30 fs; 10 Hz; Ø 700 µm HZDR Dresden

Substrate Dimensions	No.	Imperfections	Item #	Price
Ø 12.7 mm   t 6.35 mm	A4	5/ 2 x 0.025	141855	84 €
Ø 25.0 mm   t 6.35 mm	B4	5/ 1 x 0.063	141856	114 €
Ø 50.0 mm   t 9.5 mm	C3	5/ 3 x 0.063	141857	396 €
25 x 25 mm   t 6.35 mm	K2	5/ 1 x 0.063	141861	144 €

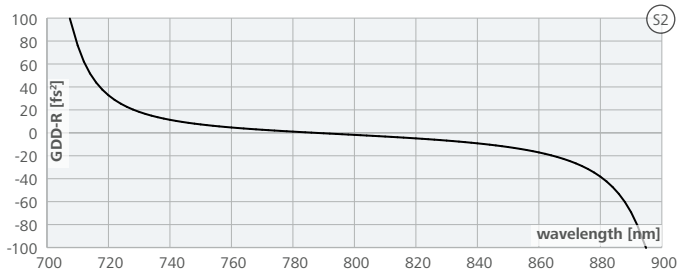
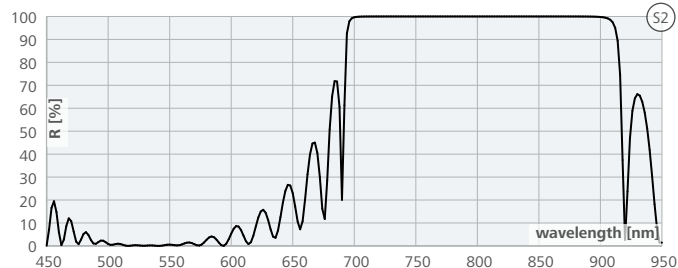
### Pump Mirror 5°

#### S2: Coating 140872

HRs,p (0–10°, 725–875 nm) > 99.9 %  
Rs,p (0–10°, 500–545 nm) < 2 %  
|GDD-Rs,p (0–10°, 725–875 nm)| < 40 fs<sup>2</sup>

#### S1: Coating 140875

ARs,p (0–10°, 500–545 nm) < 0.2 %



#### LIDT

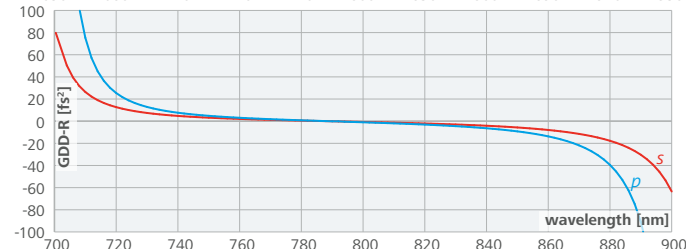
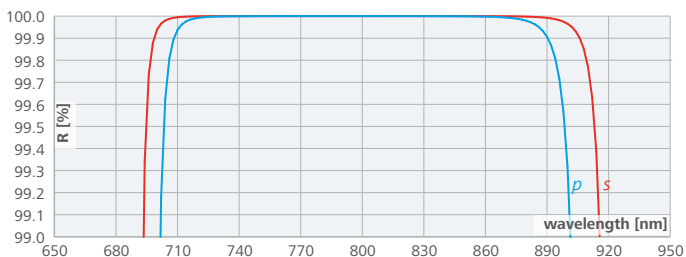
6/ 0.4 J/cm<sup>2</sup>; 800 nm; 40 fs; 1 kHz; Ø 80 µm WRCP Budapest

Substrate Dimensions	No.	Imperfections	Item #	Price
Ø 12.7   t 6.35   CC 38	R2	5/ 1 x 0.04	142340	195 €
Ø 12.7   t 6.35   CC 50	R3	5/ 1 x 0.04	142341	176 €
Ø 12.7   t 6.35   CC 75	R4	5/ 1 x 0.04	142342	176 €
Ø 12.7   t 6.35   CC 100	R5	5/ 1 x 0.04	142343	162 €
Ø 12.7   t 6.35   CC 125	R6	5/ 1 x 0.04	142345	162 €

### Turning Mirror 22.5°

#### Coating 139710

HRs,p (22.5°, 725–875 nm) > 99.9 %  
|GDD-Rs,p (22.5°, 725–875 nm)| < 75 fs<sup>2</sup>



#### LIDT

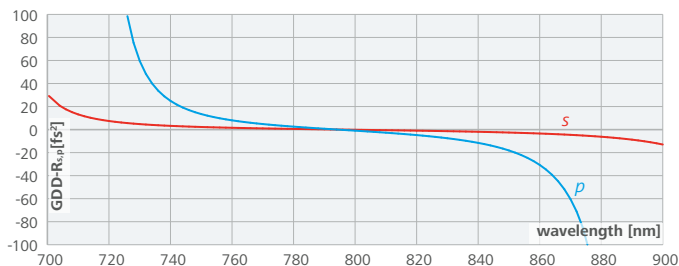
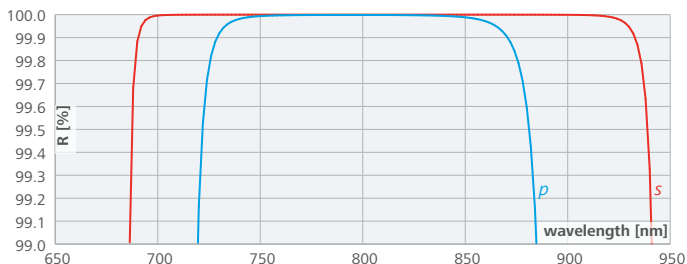
6/ 2 J/cm<sup>2</sup>; 800 nm; 70 fs; 10 Hz; Ø 700 µm HZDR Dresden  
6/ 0.4 J/cm<sup>2</sup>; 800 nm; 40 fs; 1 kHz; Ø 80 µm WRCP Budapest

Substrate Dimensions	No.	Imperfections	Item #	Price
Ø 12.7 mm   t 6.35 mm	A4	5/ 1 x 0.04	140190	108 €
Ø 25.0 mm   t 6.35 mm	B4	5/ 3 x 0.04	140191	150 €
Ø 50.0 mm   t 9.5 mm	C3	5/ 4 x 0.063	140192	498 €

### Turning Mirror 45°

#### Coating 139693

HRs,p (45°, 740–860 nm) > 99.9 %  
|GDD-Rs,p (45°, 740–860 nm)| < 75 fs<sup>2</sup>



#### LIDT

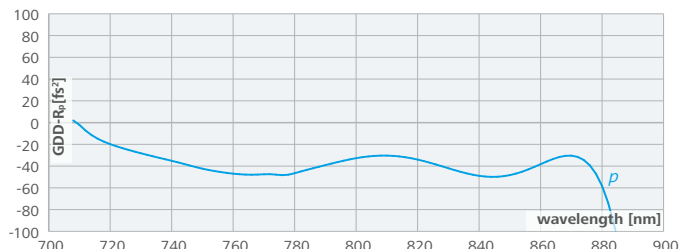
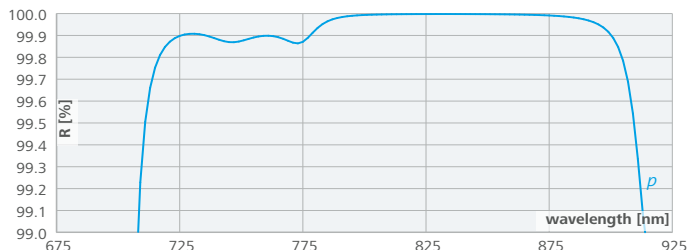
6/ 0.4 J/cm<sup>2</sup>; 800 nm; 40 fs; 1 kHz; Ø 80 µm WRCP Budapest

Substrate Dimensions	No.	Imperfections	Item #	Price
Ø 12.7 mm   t 6.35 mm	A4	5/ 1 x 0.04	140193	100 €
Ø 25.0 mm   t 6.35 mm	B4	5/ 3 x 0.04	140194	138 €
Ø 50.0 mm   t 9.5 mm	C3	5/ 4 x 0.063	140195	468 €
Ø 76.2 mm   t 12.5 mm	D1	5/ 7 x 0.063	146559	984 €
25 x 25 mm   t 6.35 mm	K2	5/ 3 x 0.04	141876	174 €

### Turning Mirror 45°, p-pol.

#### Coating 139711

HRp (45°, 725–875 nm) > 99.8 %  
GDD-Rp (45°, 725–875 nm) = -40 (±30) fs<sup>2</sup>



#### LIDT

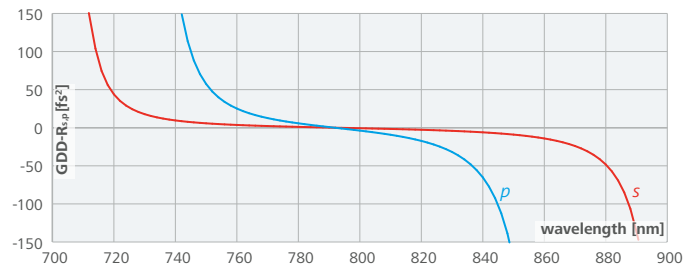
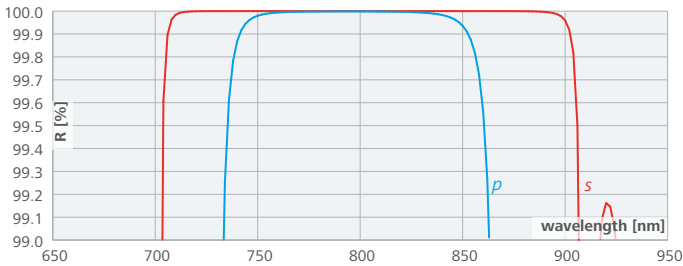
6/ 0.4 J/cm<sup>2</sup>; 800 nm; 40 fs; 1 kHz; Ø 15 µm WRCP Budapest  
6/ 0.1 J/cm<sup>2</sup>; 800 nm; 128 fs; 4.3 MHz; Ø 15 µm WRCP Budapest

Substrate Dimensions	No.	Imperfections	Item #	Price
Ø 12.7 mm   t 6.35 mm	A4	5/ 1 x 0.04	140208	138 €
Ø 25.0 mm   t 6.35 mm	B4	5/ 3 x 0.04	140209	246 €
Ø 50.0 mm   t 9.5 mm	C3	5/ 4 x 0.063	146565	732 €
Ø 76.2 mm   t 12.5 mm	D1	5/ 7 x 0.063	146566	1488 €

### Turning Mirror 45°, high power

#### Coating 140881

HRs (45°, 730–870 nm) > 99.8 %  
HRp (45°, 760–840 nm) > 99.5 %  
|GDD-Rs,p (45°, 760–840 nm)| < 80 fs<sup>2</sup>



#### LIDT

6/ 0.9 J/cm <sup>2</sup> ; 800 nm; 40 fs; 1 kHz; Ø 80 µm	WRCP Budapest
6/ 1.0 J/cm <sup>2</sup> ; 800 nm; 128 fs; 1 kHz; Ø 15 µm	WRCP Budapest
6/ 3 J/cm <sup>2</sup> ; 800 nm; 30 fs; 10 Hz; Ø 830 µm	HZDR Dresden

Substrate Dimensions	No.	Imperfections	Item #	Price
Ø 12.7 mm   t 6.35 mm	A4	5/ 2 x 0.025	140963	84 €
Ø 25.0 mm   t 6.35 mm	B4	5/ 1 x 0.063	141238	114 €
Ø 50.0 mm   t 9.5 mm	C3	5/ 3 x 0.063	141239	396 €
Ø 76.2 mm   t 12.5 mm	D1	5/ 3 x 0.1	146567	864 €
25 x 25 mm   t 6.35 mm	K2	5/ 1 x 0.063	141870	144 €

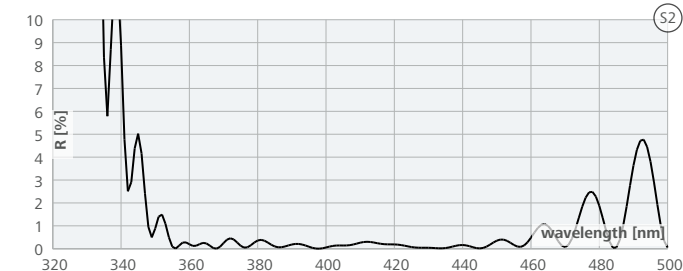
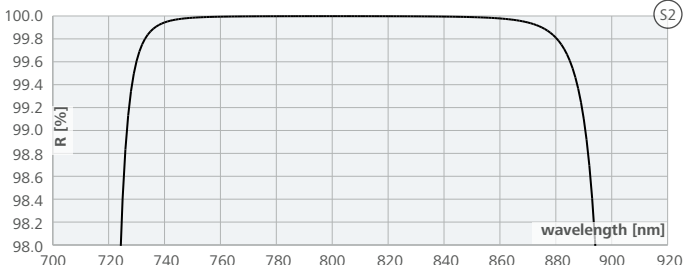
### Separator 0°, 750–850/360–450 nm

#### S2: Coating 160927

HR (0°, 750–850 nm) > 99.9 %  
R (0°, 360–440 nm) < 5 %  
|GDD-R (0°, 750–850 nm)| < 40 fs<sup>2</sup>

#### S1: Coating 160929

AR (0°, 360–440 nm) < 0.5 %



Substrate Dimensions	No.	Imperfections	Item #	Price
Ø 25.0 mm   t 3.05 mm	B3	5/ 2 x 0.04	160934	342 €

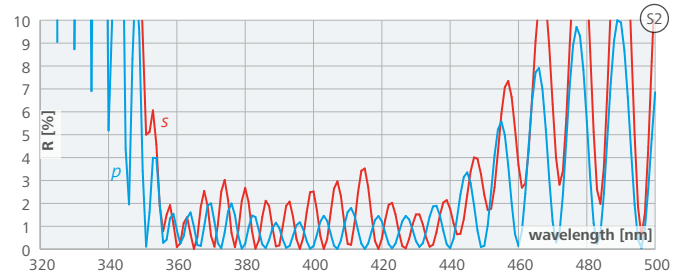
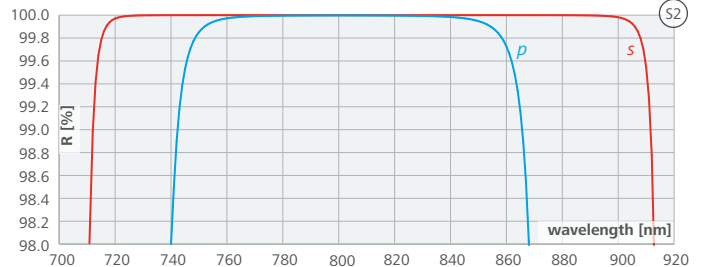
### Separator 45°, 760–850/350–450 nm

#### S2: Coating 113728

HRu (45°, (760–850 nm) ± 5 nm) > 99.9 %  
Ru (45°, (360–440 nm) ± 5 nm) < 2 %  
|GDD-Ru (45°, 760–850 nm)| < 40 fs<sup>2</sup>  
|GDD-Tu (45°, 360–440 nm)| < 40 fs<sup>2</sup>

#### S1: Coating 124879

ARu (45°, 350–450 nm) < 0.7 %



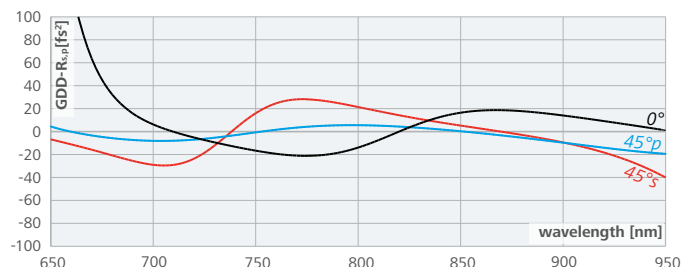
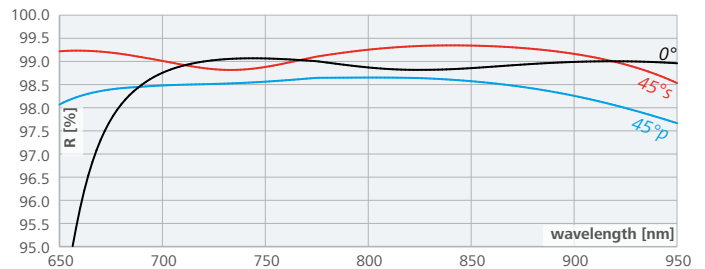
Substrate Dimensions	No.	Imperfections	Item #	Price
Ø 25.0 mm   t 3.05 mm	B3	5/ 2 x 0.04	104991	354 €

### Laser Mirror 0–45°

#### Coating 139943

#### Ag + Multilayer

HRs,p (0–45°, 725–875 nm) > 98 %  
|GDD-Rs,p (45°, 725–875 nm)| < 40 fs<sup>2</sup>



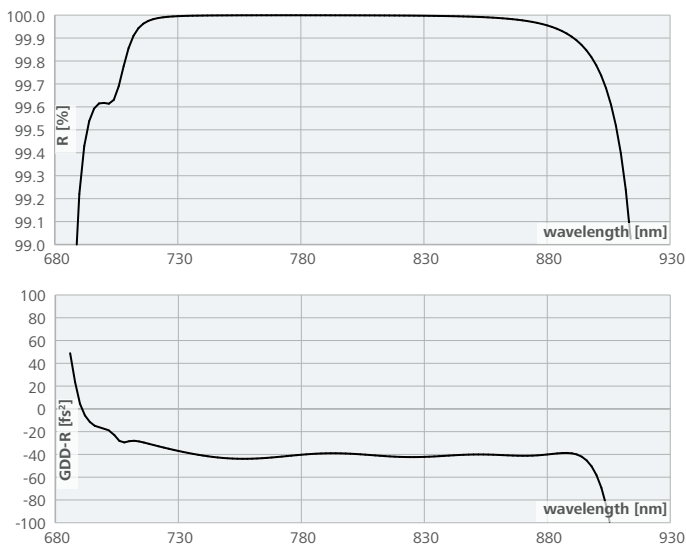
#### LIDT

6/ 0.9 J/cm<sup>2</sup>; 800 nm; 40 fs; 1 kHz; Ø 80 µm; AOI 0° WRCP Budapest

Substrate Dimensions	No.	Imperfections	Item #	Price
Ø 12.7 mm   t 6.35 mm	A4	5/ 1 x 0.04	140211	100 €
Ø 25.0 mm   t 6.35 mm	B4	5/ 3 x 0.04	140213	132 €
Ø 50.0 mm   t 9.5 mm	C3	5/ 4 x 0.063	140214	444 €
25 x 25 mm   t 6.35 mm	K2	5/ 3 x 0.04	141878	168 €

### Chirped Mirror 5°

**Coating 140884**  
**HRs,p (0–10°, 725–875 nm) > 99.9%**  
**GDD-Rs,p (0–10°, 725–875 nm) = -40 (±10) fs<sup>2</sup>**



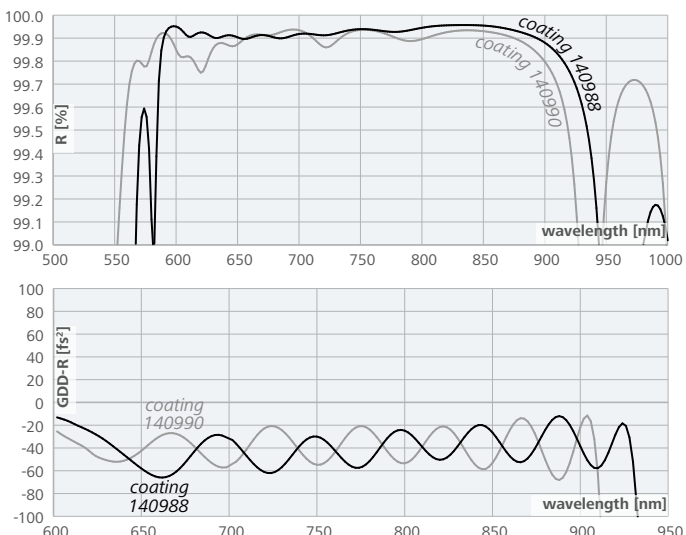
#### LIDT

6/ 0.2 J/cm<sup>2</sup>; 800 nm; 40 fs; 1 kHz; Ø 80 µm WRCP Budapest  
 6/ 0.25 J/cm<sup>2</sup>; 800 nm; 128 fs; 1 kHz; Ø 15 µm WRCP Budapest

Substrate Dimensions	No.	Imperfections	Item #	Price
Ø 12.7 mm   t 6.35 mm	A4	5/ 1 x 0.04	141243	366 €
Ø 25.0 mm   t 6.35 mm	B4	5/ 4 x 0.04	141245	570 €

### Chirped Mirror Pair 5°, -40 fs<sup>2</sup>

**Coating 140988 + 140990**  
**HRs,p (0–10°, 725–875 nm) > 99.8%**  
**GDD-Rs,p (0–10°, 725–875 nm) = -40 (±20) fs<sup>2</sup>**  
*to compensate 1 mm Fused Silica per bounce (average)*



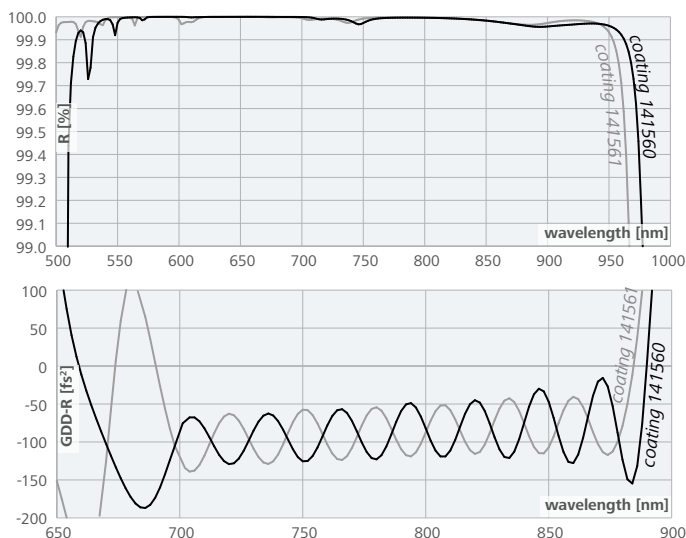
#### LIDT

6/ 0.2 J/cm<sup>2</sup>; 800 nm; 40 fs; 1 kHz; Ø 15 µm WRCP Budapest  
 6/ 0.25 J/cm<sup>2</sup>; 800 nm; 128 fs; 1 kHz; Ø 15 µm WRCP Budapest

Substrate Dimensions	No.	Imperfections	Item #	Price
Ø 12.7 mm   t 6.35 mm	A4	5/ 1 x 0.04	141882	804 €
Ø 25.0 mm   t 6.35 mm	B4	5/ 4 x 0.04	141884	1 180 €
40 x 10 mm <sup>2</sup>   t 12.5 mm	N1	5/ 3 x 0.04	141886	1 670 €

### Chirped Mirror Pair 5°, -80 fs<sup>2</sup>

**Coating 141560 + 141561**  
**HRs,p (0–10°, 725–875 nm) > 99.9%**  
**GDD-Rs,p (0–10°, 725–875 nm) = -80 (±40) fs<sup>2</sup>**  
*to compensate 2.35 mm Fused Silica per bounce (average)*



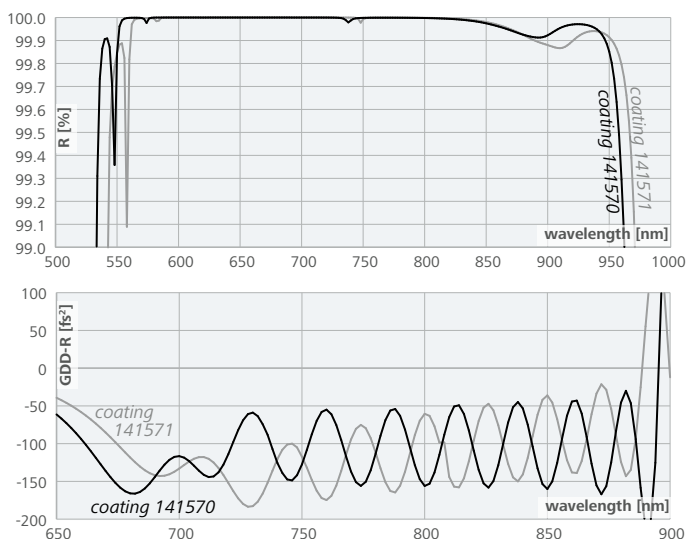
#### LIDT

6/ 0.1 J/cm<sup>2</sup>; 800 nm; 40 fs; 1 kHz; Ø 15 µm WRCP Budapest  
 6/ 0.25 J/cm<sup>2</sup>; 800 nm; 128 fs; 1 kHz; Ø 15 µm WRCP Budapest

Substrate Dimensions	No.	Imperfections	Item #	Price
Ø 12.7 mm   t 6.35 mm	A4	5/ 1 x 0.04	141887	834 €
Ø 25.0 mm   t 6.35 mm	B4	5/ 4 x 0.04	141888	1 220 €
40 x 10 mm <sup>2</sup>   t 12.5 mm	N1	5/ 3 x 0.04	141891	1 730 €

### Chirped Mirror Pair 5°, -110 fs<sup>2</sup>

**Coating 141570 + 141571**  
**HRs,p (0–10°, 725–875 nm) > 99.8%**  
**GDD-Rs,p (0–10°, 725–875 nm) = -110 (±50) fs<sup>2</sup>**  
*to compensate 3 mm Fused Silica per bounce (average)*



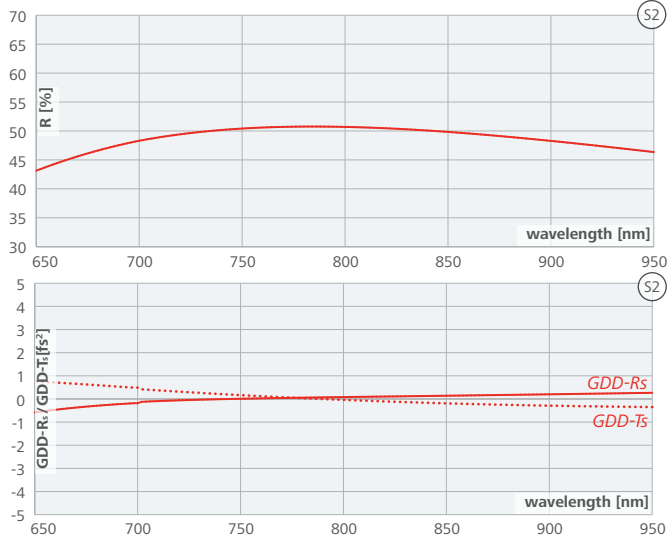
#### LIDT

6/ 0.1 J/cm<sup>2</sup>; 800 nm; 40 fs; 1 kHz; Ø 15 µm WRCP Budapest  
 6/ 0.25 J/cm<sup>2</sup>; 800 nm; 128 fs; 1 kHz; Ø 15 µm WRCP Budapest

Substrate Dimensions	No.	Imperfections	Item #	Price
Ø 12.7 mm   t 6.35 mm	A4	5/ 1 x 0.04	141920	864 €
Ø 25.0 mm   t 6.35 mm	B4	5/ 4 x 0.04	141919	1 250 €
40 x 10 mm <sup>2</sup>   t 12.5 mm	N1	5/ 3 x 0.04	141918	1 790 €

### Beamsplitter 45°, s-pol.

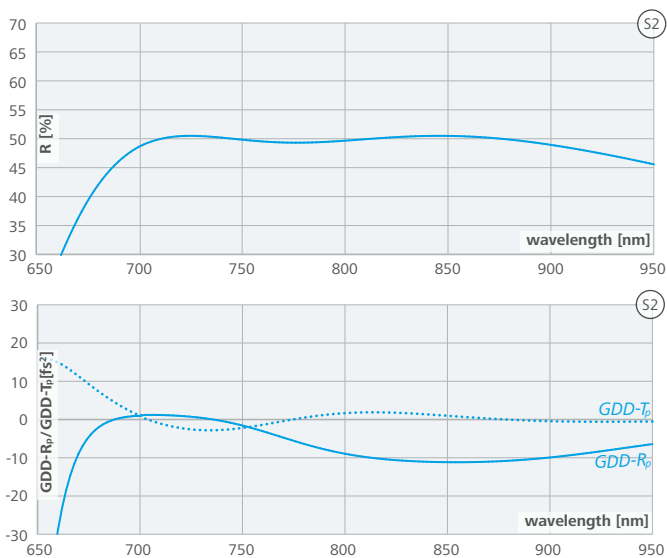
- S2: Coating 141113**  
**PRs (45°, 725–875 nm) = 50 (±2) %**  
**|GDD-Rs (725–875 nm)| < 5 fs<sup>2</sup>**  
**S1: Coating 141114**  
**ARs (45°, 725–875 nm) < 0.5 %**



Substrate Dimensions	No.	Imperfections	Item #	Price
Ø 25.0 mm   t 0.5 mm	B1	5/ 4 x 0.04	141512	348 €
Ø 25.0 mm   t 1.0 mm	B2	5/ 3 x 0.04	141511	324 €
Ø 25.0 mm   t 3.05 mm	B3	5/ 3 x 0.04	141502	264 €

### Beamsplitter 45°, p-pol.

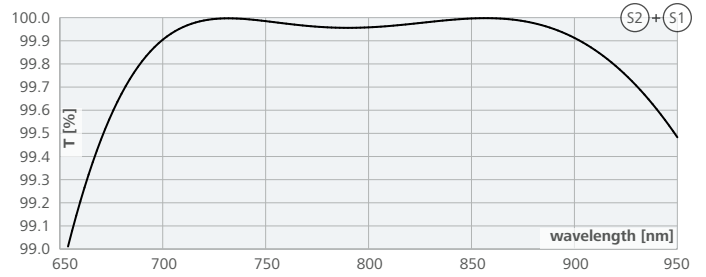
- S2: Coating 141122**  
**PRp (45°, 725–875 nm) = 50 (±2) %**  
**|GDD-Rp (45°, 725–875 nm)| < 20 fs<sup>2</sup>**  
**S1: Coating 141121**  
**ARp (45°, 725–875 nm) < 0.2 %**



Substrate Dimensions	No.	Imperfections	Item #	Price
Ø 25.0 mm   t 0.5 mm	B1	5/ 4 x 0.04	141513	348 €
Ø 25.0 mm   t 1.0 mm	B2	5/ 3 x 0.04	141509	324 €
Ø 25.0 mm   t 3.05 mm	B3	5/ 3 x 0.04	141506	264 €

### Window 0°

- S2+S1: Coating 140890**  
**ARs,p (0–15°, 725–875 nm) < 0.2 %**

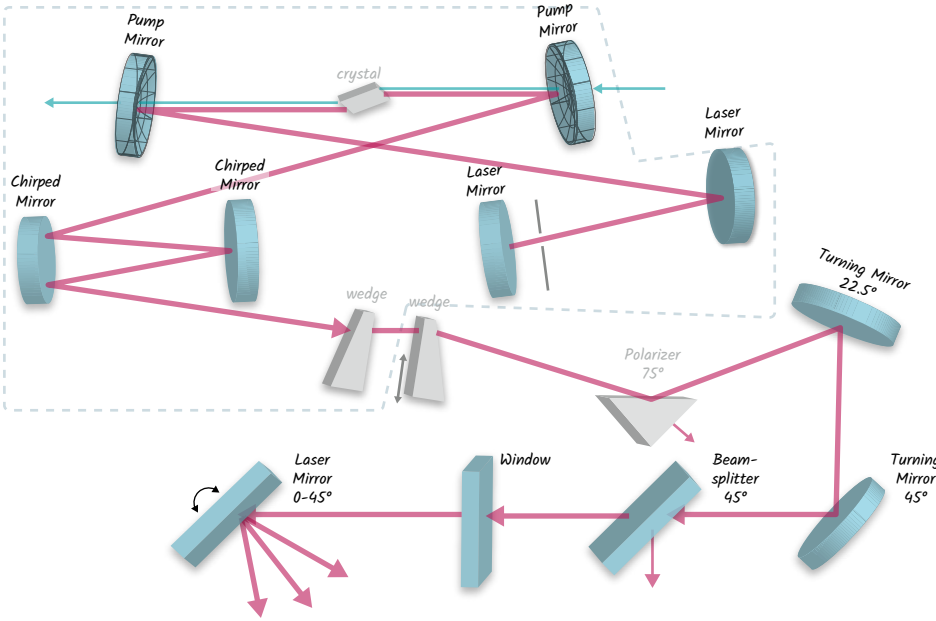


#### LIDT

- 6/ 0.4 J/cm<sup>2</sup>; 800 nm; 40 fs; 1 kHz; Ø 15 µm WRCP Budapest  
 6/ 0.5 J/cm<sup>2</sup>; 800 nm; 128 fs; 1 kHz; Ø 15 µm WRCP Budapest

Substrate Dimensions	No.	Imperfections	Item #	Price
Ø 25.0 mm   t 1.0 mm	B2	5/ 3 x 0.04	141514	216 €
Ø 25.0 mm   t 3.05 mm	B3	5/ 3 x 0.04	141519	156 €

# fs-Laser [TiSa, 300 nm bandwidth]

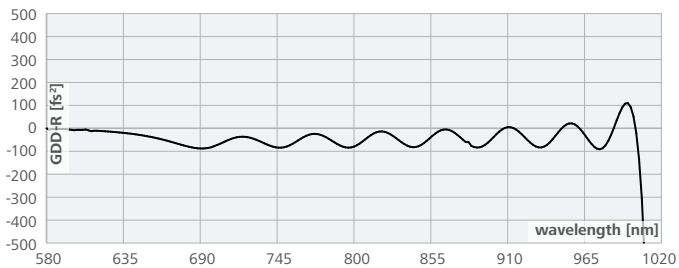
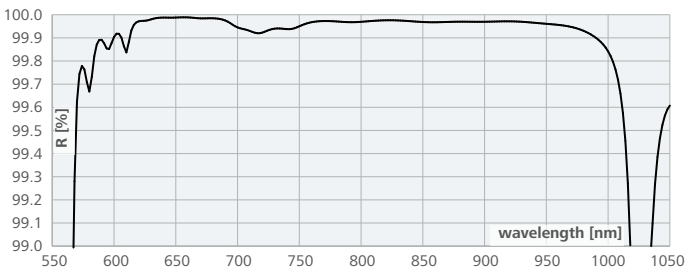


Laser Mirror 0°	109
Pump Mirror Pair 0°	109
Turning Mirror 22.5°	110
Turning Mirror 45°, p-pol.	110
Turning Mirror 45°, s-pol.	110
Turning Mirror 45°	110
Laser Mirror 0–45°	111
Chirped Mirror Pair 5°	111
Beamsplitter 45°, p-pol.	111
Beamsplitter 45°, s-pol.	112
Polarizer 75°	112
Window 0°	112

For optics not specified here, please visit [www.layertec.de](http://www.layertec.de), contact us at [info@layertec.de](mailto:info@layertec.de) or call us at +49 (0)36453 744 0.

## Laser Mirror 0°

**Coating 141318**  
**HRs,p (0–10°, 670–970 nm) > 99.9%**  
**GDD-Rs,p (0–10°, 670–970 nm) = -50 (±75) fs<sup>2</sup>**  
*to compensate 1.4 mm Fused Silica per bounce (average)*



### LIDT

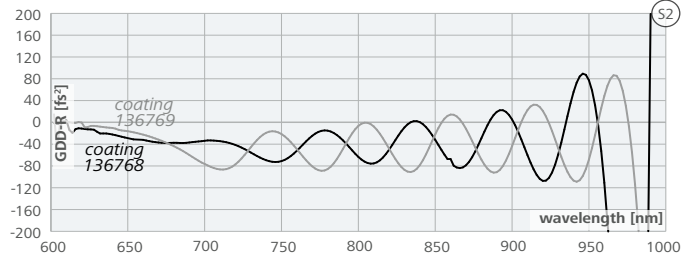
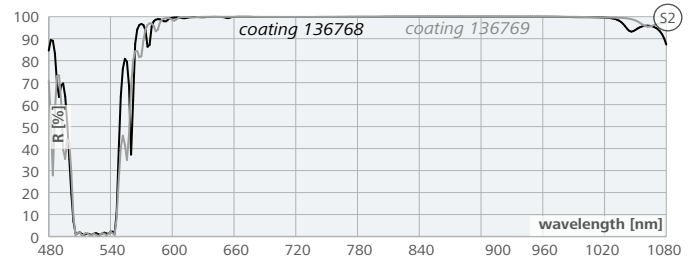
6/ 0.1 J/cm<sup>2</sup>; 800 nm; 40 fs; 1 kHz; Ø 15 µm WRCP Budapest  
 6/ 0.25 J/cm<sup>2</sup>; 800 nm; 128 fs; 1 kHz; Ø 15 µm WRCP Budapest

Substrate Dimensions	No.	Imperfections	Item #	Price
Ø 12.7 mm   t 6.35 mm	A4	5/ 1 x 0.04	142010	348 €
Ø 25.0 mm   t 6.35 mm	B4	5/ 4 x 0.04	142012	552 €

## Pump Mirror Pair 0°

**S2: Coating 136768+136769**  
**HRs,p (0–10°, 670–970 nm) > 99.8%**  
**Rs,p (0–10°, 510–535 nm) < 10%**  
**GDD-Rs,p (0–10°, 680–960 nm) = -50 (±150) fs<sup>2</sup>**  
*to compensate 1.2 mm Fused Silica per bounce (average)*

**S1: Coating 140875**  
**ARs,p (0–10°, 500–545 nm) < 0.2%**



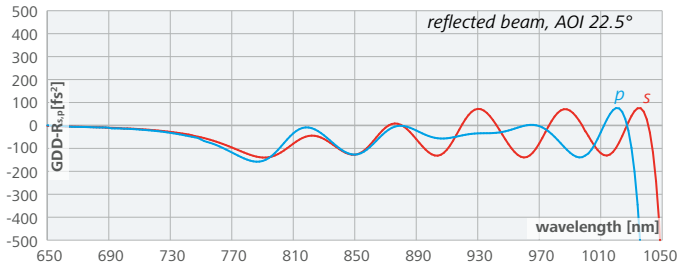
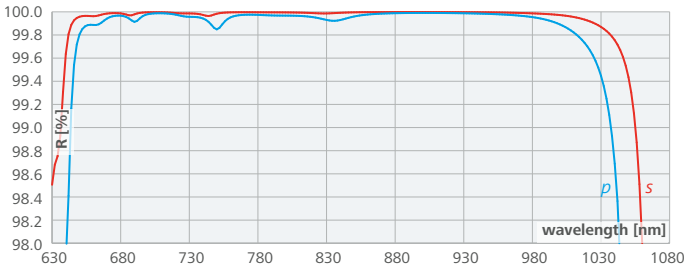
### LIDT

6/ 0.1 J/cm<sup>2</sup>; 800 nm; 40 fs; 1 kHz; Ø 15 µm WRCP Budapest  
 6/ 0.25 J/cm<sup>2</sup>; 800 nm; 128 fs; 1 kHz; Ø 15 µm WRCP Budapest

Substrate Dimensions [mm]	No.	Imperfections	Item #	Price
Ø 12.7   t 6.35   CC38	R2	5/ 1 x 0.04	142351	930 €
Ø 12.7   t 6.35   CC50	R3	5/ 1 x 0.04	142350	890 €
Ø 12.7   t 6.35   CC75	R4	5/ 1 x 0.04	142349	890 €
Ø 12.7   t 6.35   CC100	R5	5/ 1 x 0.04	142348	864 €
Ø 12.7   t 6.35   CC125	R6	5/ 1 x 0.04	142347	864 €

### Turning Mirror 22.5°

**Coating 141503**  
HRs,p (22.5°, 670–970 nm) > 99.8 %  
GDD-Rs,p (22.5°, 670–970 nm) = -200 ... + 200 fs<sup>2</sup>



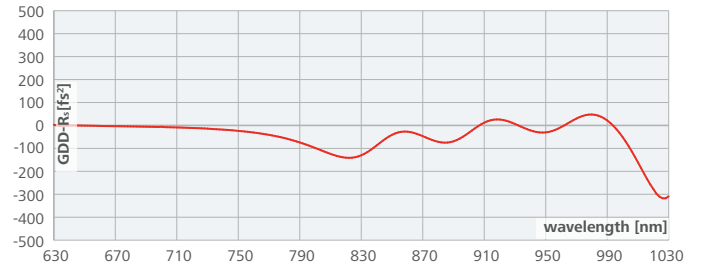
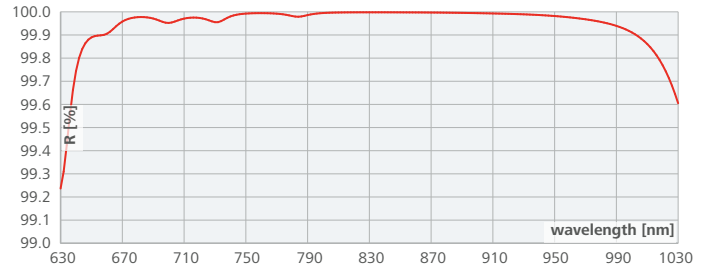
#### LIDT

6/ 0.1 J/cm<sup>2</sup>; 800 nm; 40 fs; 1 kHz; Ø 15 µm WRCP Budapest  
6/ 0.25 J/cm<sup>2</sup>; 800 nm; 128 fs; 1 kHz; Ø 15 µm WRCP Budapest

Substrate Dimensions	No.	Imperfections	Item #	Price
Ø 12.7 mm   t 6.35 mm	A4	5/ 1 x 0.04	141584	150 €
Ø 25.0 mm   t 6.35 mm	B4	5/ 3 x 0.04	141567	276 €
Ø 50.0 mm   t 9.5 mm	C3	5/ 4 x 0.063	141925	792 €

### Turning Mirror 45°, s-pol.

**Coating 141507**  
HRs (45°, 670–970 nm) > 99.9 %  
GDD-Rs (45°, 670–970 nm) = -200 ... + 200 fs<sup>2</sup>



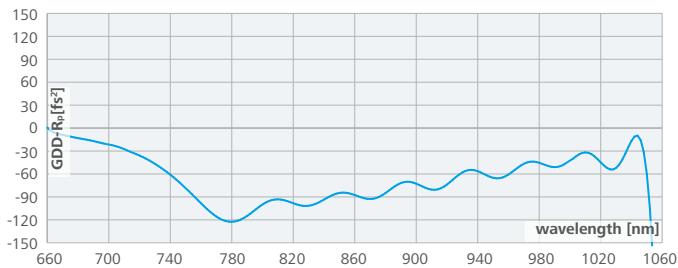
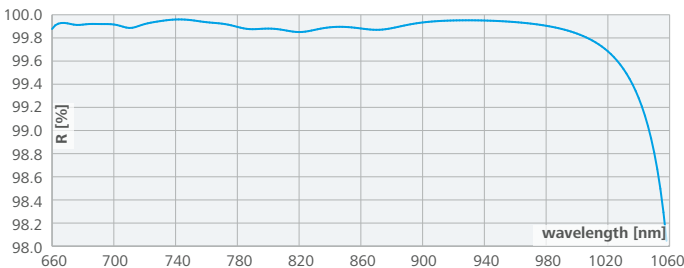
#### LIDT

6/ 0.1 J/cm<sup>2</sup>; 800 nm; 40 fs; 1 kHz; Ø 15 µm WRCP Budapest  
6/ 0.25 J/cm<sup>2</sup>; 800 nm; 128 fs; 1 kHz; Ø 15 µm WRCP Budapest

Substrate Dimensions	No.	Imperfections	Item #	Price
Ø 12.7 mm   t 6.35 mm	A4	5/ 1 x 0.04	141586	144 €
Ø 25.0 mm   t 6.35 mm	B4	5/ 3 x 0.04	141578	264 €
Ø 50.0 mm   t 9.5 mm	C3	5/ 4 x 0.063	141928	768 €
Ø 76.2 mm   t 12.5 mm	D1	5/ 7 x 0.063	146570	1590 €

### Turning Mirror 45°, p-pol.

**Coating 141520**  
HRp (45°, 670–970 nm) > 99.8 %  
GDD-Rp (45°, 670–970 nm) = -200 ... 0 fs<sup>2</sup>



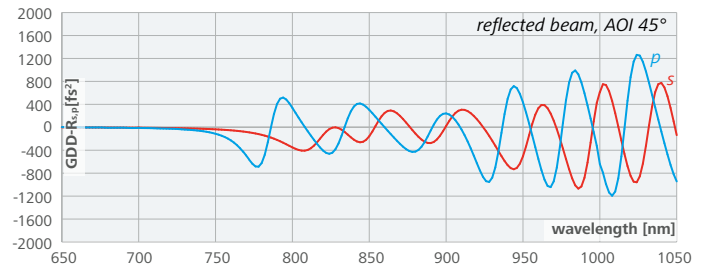
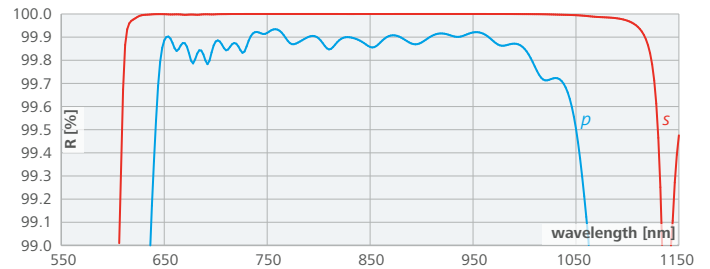
#### LIDT

6/ 0.1 J/cm<sup>2</sup>; 800 nm; 40 fs; 1 kHz; Ø 15 µm WRCP Budapest  
6/ 0.25 J/cm<sup>2</sup>; 800 nm; 128 fs; 1 kHz; Ø 15 µm WRCP Budapest

Substrate Dimensions	No.	Imperfections	Item #	Price
Ø 12.7 mm   t 6.35 mm	A4	5/ 1 x 0.04	141585	150 €
Ø 25.0 mm   t 6.35 mm	B4	5/ 3 x 0.04	141568	276 €
Ø 50.0 mm   t 9.5 mm	C3	5/ 4 x 0.063	141926	792 €
Ø 76.2 mm   t 12.5 mm	D1	5/ 7 x 0.063	146569	1620 €

### Turning Mirror 45°

**Coating 141522**  
HRs,p (45°, 670–970 nm) > 99.7 %  
|GDD-Rs,p (45°, 670–970 nm)| < 1500 fs<sup>2</sup>



#### LIDT

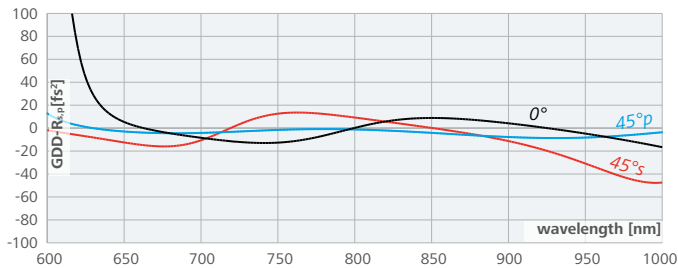
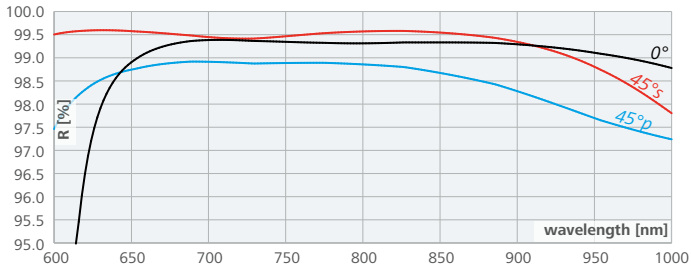
6/ 0.1 J/cm<sup>2</sup>; 800 nm; 40 fs; 1 kHz; Ø 15 µm WRCP Budapest  
6/ 0.25 J/cm<sup>2</sup>; 800 nm; 128 fs; 1 kHz; Ø 15 µm WRCP Budapest

Substrate Dimensions	No.	Imperfections	Item #	Price
Ø 12.7 mm   t 6.35 mm	A4	5/ 1 x 0.04	141587	150 €
Ø 25.0 mm   t 6.35 mm	B4	5/ 3 x 0.04	141579	276 €
Ø 50.0 mm   t 9.5 mm	C3	5/ 4 x 0.063	141930	792 €



### Laser Mirror 0–45°

**Coating 141523**  
**Ag+ Multilayer**  
**HRs,p (0–45°, 670–970 nm) > 97%**  
**|GDD-Rs,p (0–45°, 670–970 nm)| < 50 fs<sup>2</sup>**  
*for application outside the resonator*



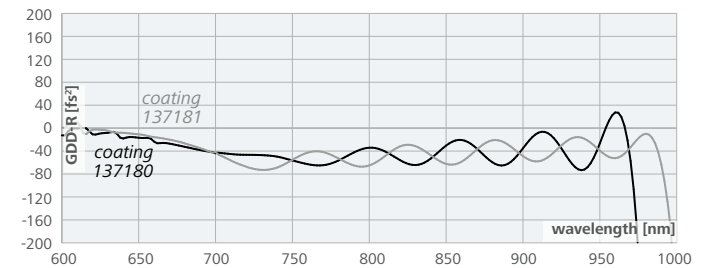
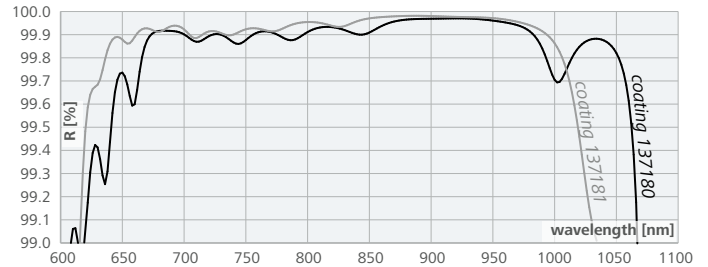
#### LIDT

6/ 0.4 J/cm<sup>2</sup>; 800 nm; 40 fs; 1 kHz; Ø 15 µm WRCP Budapest  
 6/ 1.5 J/cm<sup>2</sup>; 800 nm; 30 fs; 10 kHz; Ø 700 µm HZDR Dresden

Substrate Dimensions	No.	Imperfections	Item #	Price
Ø 12.7 mm   t 6.35 mm	A4	5/ 1 x 0.04	142001	105 €
Ø 25.0 mm   t 6.35 mm	B4	5/ 3 x 0.04	142002	138 €
Ø 50.0 mm   t 9.5 mm	C3	5/ 4 x 0.063	142003	462 €
25 x 25 mm   t 6.35 mm	K2	5/ 3 x 0.04	142005	177 €

### Chirped Mirror Pair 5°

**Coating 137180+ 137181**  
**HRs,p (0–10°, 670–970 nm) > 99.8%**  
**GDD-Rs,p (0–10°, 680–960 nm) = -50 (±150) fs<sup>2</sup>**  
*to compensate 1.4 mm Fused Silica per bounce (average)*



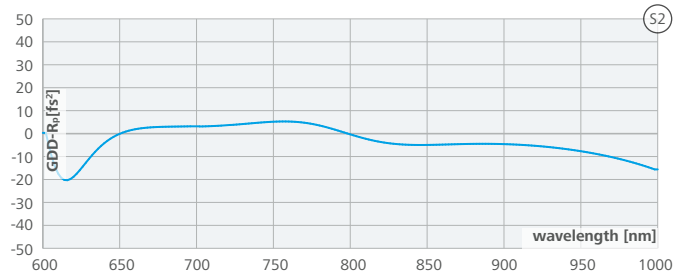
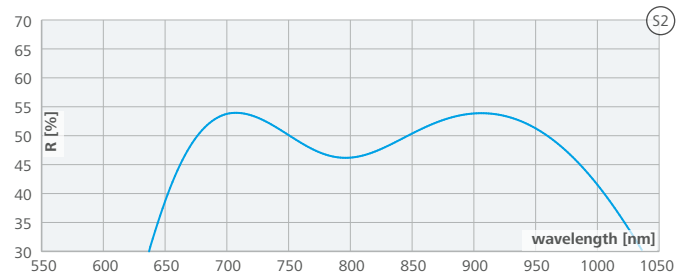
#### LIDT

6/ 0.1 J/cm<sup>2</sup>; 800 nm; 40 fs; 1 kHz; Ø 15 µm WRCP Budapest  
 6/ 0.25 J/cm<sup>2</sup>; 800 nm; 128 fs; 1 kHz; Ø 15 µm WRCP Budapest

Substrate Dimensions	No.	Imperfections	Item #	Price
Ø 12.7 mm   t 6.35 mm	A4	5/ 1 x 0.04	141931	834 €
Ø 25.0 mm   t 6.35 mm	B4	5/ 4 x 0.04	141933	1 220 €
40 x 10 mm <sup>2</sup>   t 12.5 mm	N1	5/ 3 x 0.04	141934	1 730 €

### Beamsplitter 45°, p-pol.

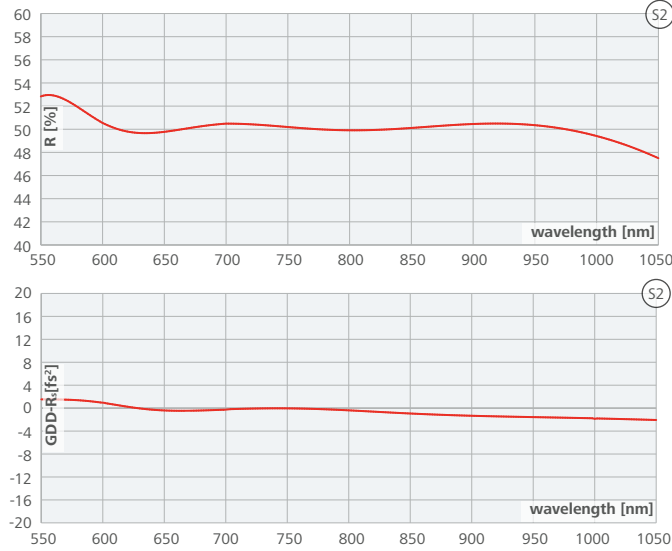
**S2: Coating 141555**  
**PRp (45°, 670–970 nm) = 50 (±5) %**  
**|GDD-Rp (45°, 670–970 nm)| < 10 fs<sup>2</sup>**  
**S1: Coating 141556**  
**ARp (45°, 670–970 nm) < 0.2 %**



Substrate Dimensions	No.	Imperfections	Item #	Price
Ø 25.0 mm   t 1 mm	B2	5/ 3 x 0.04	141975	348 €
Ø 25.0 mm   t 3.05 mm	B3	5/ 3 x 0.04	141978	288 €

### Beamsplitter 45°, s-pol.

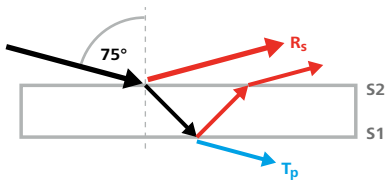
- S2: Coating 141558**  
**PRs (45°, 670–970 nm) = 50 (±5) %**  
**|GDD-Rs (45°, 670–970 nm)| < 5 fs<sup>2</sup>**  
**S1: Coating 141557**  
**ARs (45°, 670–970 nm) < 0.7 %**



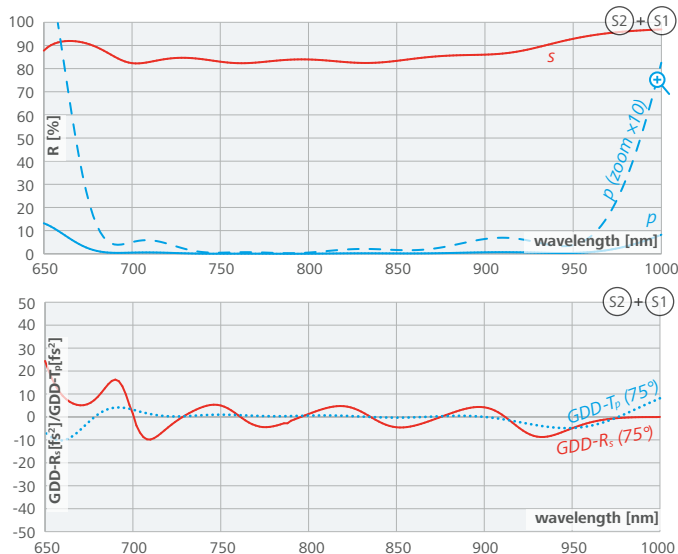
Substrate Dimensions	No.	Imperfections	Item #	Price
Ø 25.0 mm   t 1 mm	B2	5/ 3 x 0.04	141977	348 €
Ø 25.0 mm   t 3.05 mm	B3	5/ 3 x 0.04	141979	288 €

### Polarizer 75°

- S2+S1: Coating 141529**  
**TFP (75°, 670–970 nm) Rs > 80% Rp < 1 %**  
**|GDD-Rs (75°, 670–970 nm)| < 20 fs<sup>2</sup>**  
**|GDD-Tp (75°, 680–960 nm)| < 5 fs<sup>2</sup>**



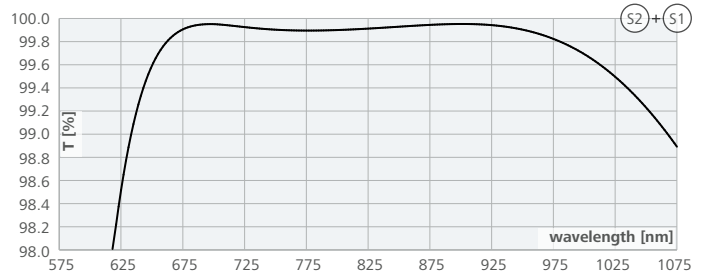
**Polarizer**  
 Special item for  
 clean separation  
 of p-pol. light.



Substrate Dimensions	No.	Imperfections	Item #	Price
Ø 25.0 mm   t 1 mm	B2	5/ 3 x 0.04	142013	438 €
Ø 25.0 mm   t 3.05 mm	B3	5/ 3 x 0.04	142014	378 €

### Window 0°

- S2+S1: Coating 141528**  
**ARs,p (0–15°, 670–970 nm) < 0.25 %**

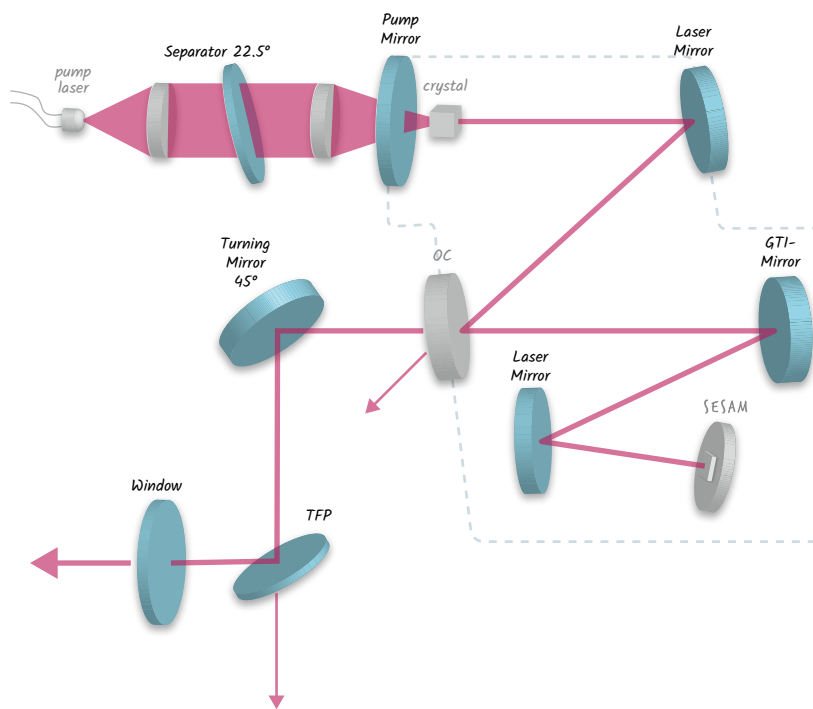


#### LIDT

- 6/ 0.4 J/cm<sup>2</sup>; 800 nm; 40 fs; 1 kHz; Ø 15 µm WRCP Budapest  
 6/ 0.5 J/cm<sup>2</sup>; 800 nm; 128 fs; 1 kHz; Ø 15 µm WRCP Budapest

Substrate Dimensions	No.	Imperfections	Item #	Price
Ø 25.0 mm   t 1 mm	B2	5/ 3 x 0.04	141588	234 €
Ø 25.0 mm   t 3.05 mm	B3	5/ 3 x 0.04	141590	174 €

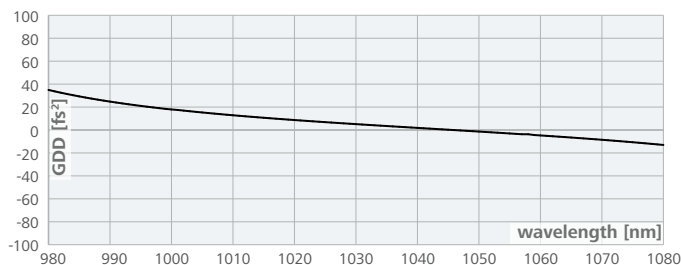
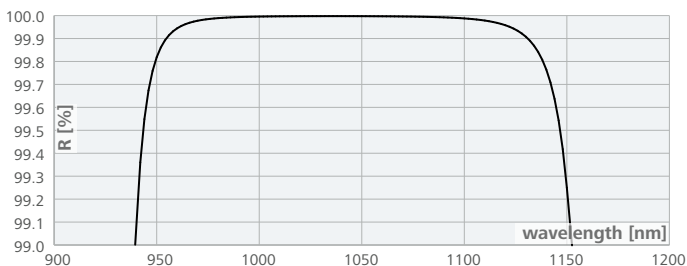
# ps/fs-Laser [1030–1040 nm]



- Laser Mirror 0° . . . . . 113
- Pump Mirror 0°, 800–982 nm . . . . . 113
- Pump Mirror 0°, 960–982 nm . . . . . 114
- Turning Mirror 45° . . . . . 114
- GTI-Mirror 5°, 1 030 nm, -250 fs<sup>2</sup> . . . . . 114
- GTI-Mirror 5°, 1 030 nm, -550 fs<sup>2</sup> . . . . . 114
- GTI-Mirror 5°, 1 030 nm, -1 000 fs<sup>2</sup> . . . . . 115
- GTI-Mirror 5°, 1 040 nm, -250 fs<sup>2</sup> . . . . . 115
- GTI-Mirror 5°, 1 040 nm, -550 fs<sup>2</sup> . . . . . 115
- GTI-Mirror 5°, 1 040 nm, -1 000 fs<sup>2</sup> . . . . . 115
- Separator 22.5° . . . . . 116
- Thin Film Polarizer 45°, 1 030 nm . . . . . 116
- Thin Film Polarizer 45°, 1 042 nm . . . . . 116
- Thin Film Polarizer 56°, 1 030 nm . . . . . 116
- Thin Film Polarizer 56°, 1 042 nm . . . . . 116
- Window 0° . . . . . 116

## Laser Mirror 0°

**Coating 139374**  
**HRs,p (0–10°, 1 030–1 042 nm) > 99.99 %**  
**|GDD-Rs,p (0–10°, 1 030–1 042 nm)| < 20 fs<sup>2</sup>**



### LIDT

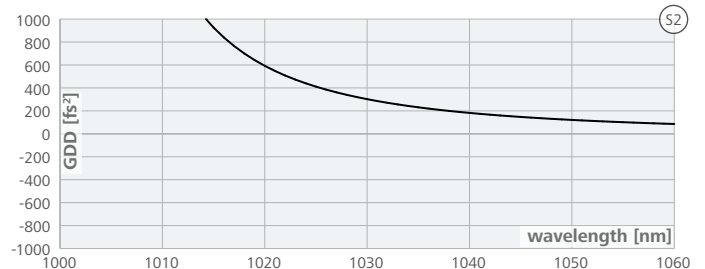
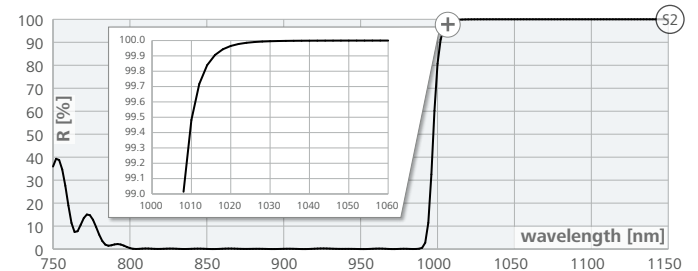
6/ 3 J/cm<sup>2</sup>; 1030 nm; 10 ps; 1 kHz; Ø 50 µm LIDARIS Vilnius

Substrate Dimensions	No.	Imperfections	Item #	Price
Ø 12.7 mm   t 6.35 mm	A4	5/ 1 x 0.04	141246	126 €
Ø 25.0 mm   t 6.35 mm	B4	5/ 3 x 0.04	141248	204 €
Ø 50.0 mm   t 9.5 mm	C3	5/ 4 x 0.063	141249	660 €
25 x 25 mm   t 6.35 mm	K2	5/ 3 x 0.04	139564	270 €

## Pump Mirror 0°, 800–982 nm

**S2: Coating 141171**  
**HR (0°, 1 030–1 040 nm) > 99.9 %**  
**R (0°, 800–982 nm) < 5 %**  
**GDD-R (0°, 1 030–1 040 nm) = 300 (±300) fs<sup>2</sup>**  
*cut on/off R (0°) = T (0°) = 50 % at 995 (±10) nm*  
*AOI 0° → 10°: shift cut on/off-wavelength -5 nm*

**S1: Coating 141174**  
**AR (0°, 800–1 000 nm) < 0.5 %**



Substrate Dimensions	No.	Imperfections	Item #	Price
Ø 12.7 mm   t 6.35 mm	A4	5/ 1 x 0.04	141951	378 €
Ø 25.0 mm   t 6.35 mm	B4	5/ 4 x 0.04	141530	552 €

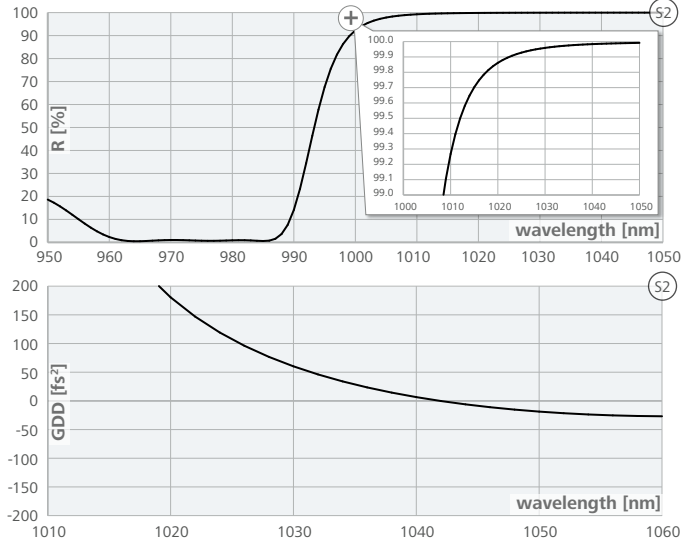
**Pump Mirror 0°, 960–982 nm**

**S2: Coating 141181**

HR (0°, 1030–1040 nm) > 99.9 %  
R (0°, 960–982 nm) < 5 %  
|GDD-R (0°, 1030–1040 nm)| < 100 fs<sup>2</sup>  
cut on/off R (0°) = T (0°) = 50 % at 994 (±5) nm  
AOI 0° → 10°: shift cut/off-wavelength -5 nm

**S1: Coating 141184**

AR (0°, 950–1050 nm) < 0.2 %

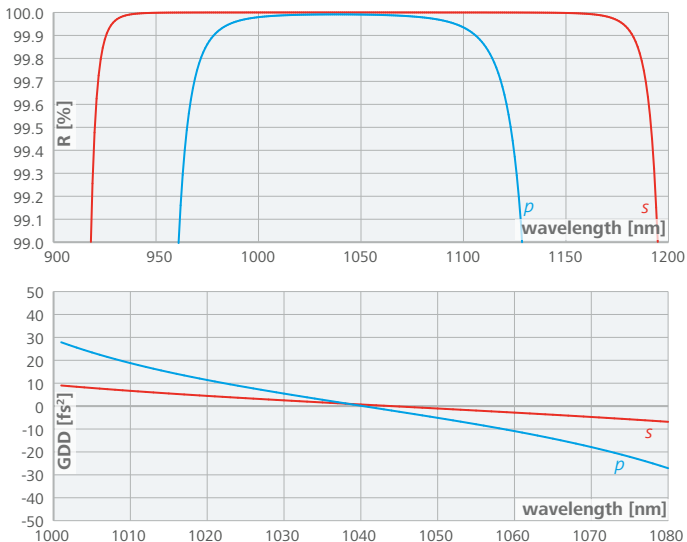


Substrate Dimensions	No.	Imperfections	Item #	Price
Ø 12.7 mm   t 6.35 mm	A4	5/ 1 x 0.04	141952	414 €
Ø 25.0 mm   t 6.35 mm	B4	5/ 4 x 0.04	141525	612 €

**Turning Mirror 45°**

**Coating 141317**

HRs,p (45°, 1030–1040 nm) > 99.9 %  
|GDD-Rs,p (45°, 1030–1040 nm)| < 20 fs<sup>2</sup>

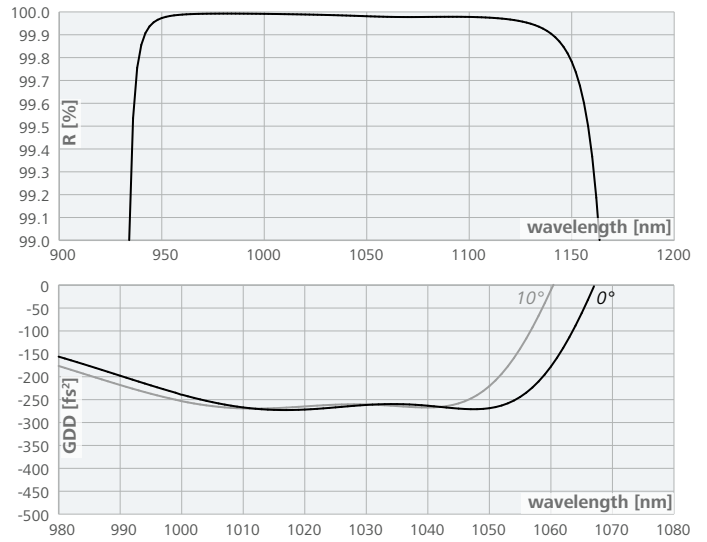


Substrate Dimensions	No.	Imperfections	Item #	Price
Ø 12.7 mm   t 6.35 mm	A4	5/ 1 x 0.04	141569	100 €
Ø 25.0 mm   t 6.35 mm	B4	5/ 3 x 0.04	141501	142 €
Ø 50.0 mm   t 9.5 mm	C3	5/ 4 x 0.063	141572	516 €
25 x 25 mm   t 6.35 mm	K2	5/ 3 x 0.04	141573	180 €

**GTI-Mirror 5°, 1030 nm, -250 fs<sup>2</sup>**

**Coating 141126**

HRs,p (0–10°, 1030 nm) > 99.95 %  
GDD-Rp (0–10°, 1030 nm) = -250 (±50) fs<sup>2</sup>

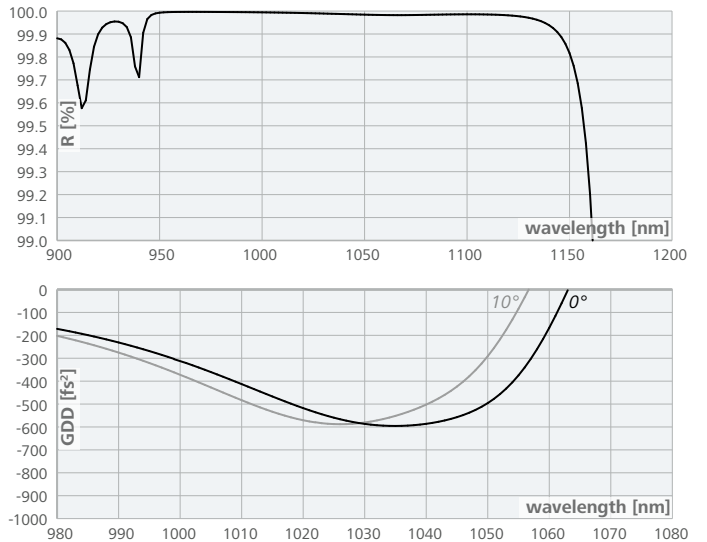


Substrate Dimensions	No.	Imperfections	Item #	Price
Ø 12.7 mm   t 6.35 mm	A4	5/ 1 x 0.04	141250	372 €
Ø 25.0 mm   t 6.35 mm	B4	5/ 4 x 0.04	141251	576 €

**GTI-Mirror 5°, 1030 nm, -550 fs<sup>2</sup>**

**Coating 141149**

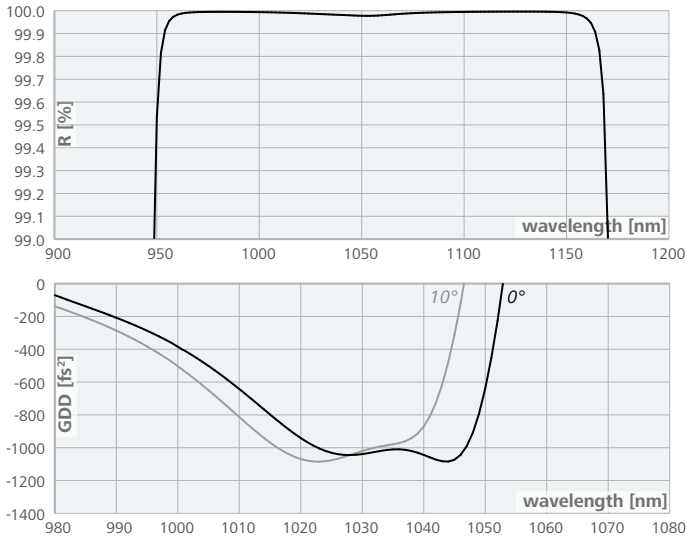
HRs,p (0–10°, 1030 nm) > 99.95 %  
GDD-Rp (0–10°, 1030 nm) = -550 (±100) fs<sup>2</sup>



Substrate Dimensions	No.	Imperfections	Item #	Price
Ø 12.7 mm   t 6.35 mm	A4	5/ 1 x 0.04	141255	390 €
Ø 25.0 mm   t 6.35 mm	B4	5/ 4 x 0.04	141257	600 €

**GTI-Mirror 5°, 1 030 nm, -1 000 fs<sup>2</sup>**

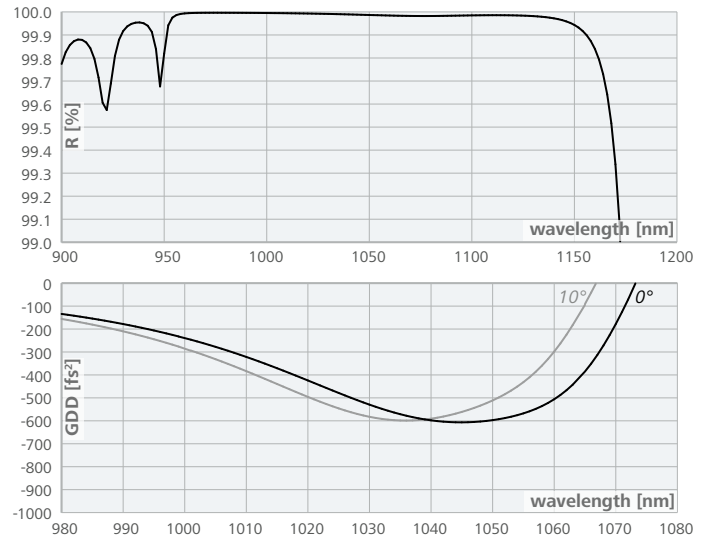
**Coating 141151**  
**HRs,p (0–10°, 1 030 nm) > 99.95 %**  
**GDD-Rp (0–10°, 1 030 nm) = -1 000 (±200) fs<sup>2</sup>**



Substrate Dimensions	No.	Imperfections	Item #	Price
Ø 12.7 mm   t 6.35 mm	A4	5/ 1 x 0.04	141260	408 €
Ø 25.0 mm   t 6.35 mm	B4	5/ 4 x 0.04	141261	624 €

**GTI-Mirror 5°, 1 040 nm, -550 fs<sup>2</sup>**

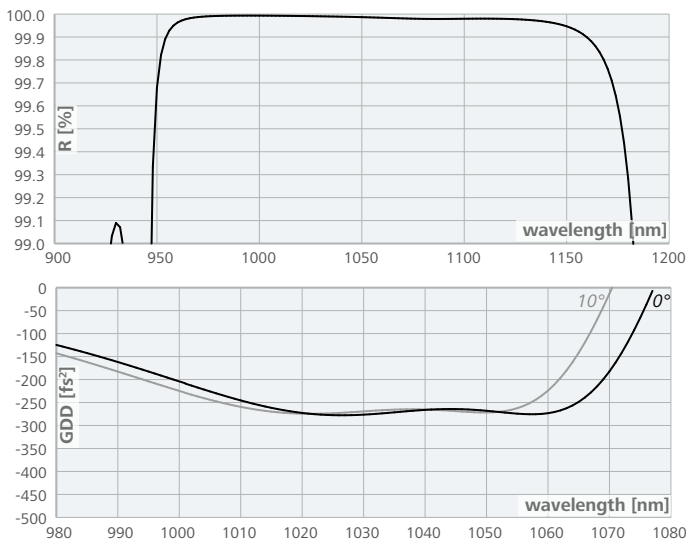
**Coating 141150**  
**HRs,p (0–10°, 1 040 nm) > 99.95 %**  
**GDD-Rp (0–10°, 1 040 nm) = -550 (±100) fs<sup>2</sup>**



Substrate Dimensions	No.	Imperfections	Item #	Price
Ø 12.7 mm   t 6.35 mm	A4	5/ 1 x 0.04	141269	390 €
Ø 25.0 mm   t 6.35 mm	B4	5/ 4 x 0.04	141270	600 €

**GTI-Mirror 5°, 1 040 nm, -250 fs<sup>2</sup>**

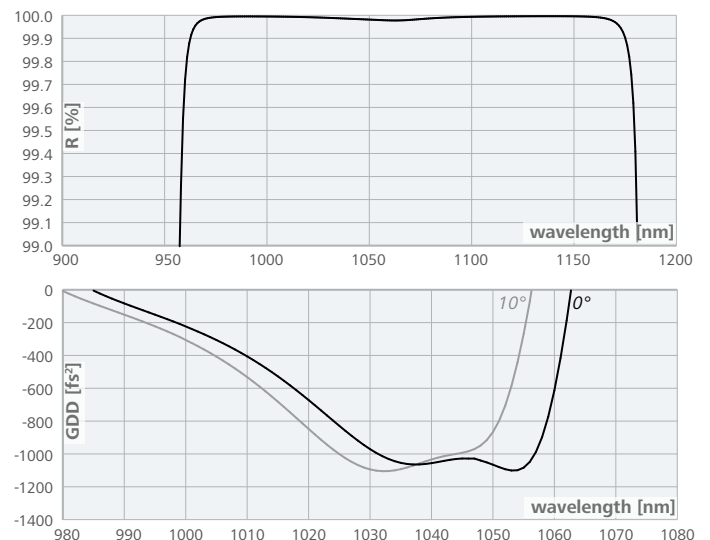
**Coating 141148**  
**HRs,p (0–10°, 1 040 nm) > 99.95 %**  
**GDD-Rp (0–10°, 1 040 nm) = -250 (±50) fs<sup>2</sup>**



Substrate Dimensions	No.	Imperfections	Item #	Price
Ø 12.7 mm   t 6.35 mm	A4	5/ 1 x 0.04	141263	372 €
Ø 25.0 mm   t 6.35 mm	B4	5/ 4 x 0.04	141266	576 €

**GTI-Mirror 5°, 1 040 nm, -1 000 fs<sup>2</sup>**

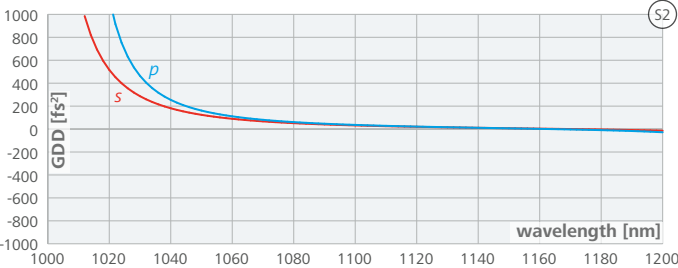
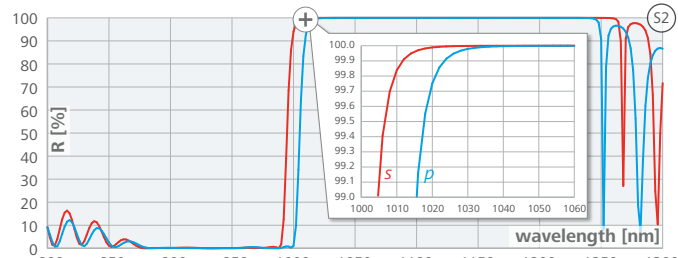
**Coating 141152**  
**HRs,p (0–10°, 1 040 nm) > 99.95 %**  
**GDD-Rp (0–10°, 1 040 nm) = -1 000 (±200) fs<sup>2</sup>**



Substrate Dimensions	No.	Imperfections	Item #	Price
Ø 12.7 mm   t 6.35 mm	A4	5/ 1 x 0.04	141273	408 €
Ø 25.0 mm   t 6.35 mm	B4	5/ 4 x 0.04	141274	624 €

### Separator 22.5°

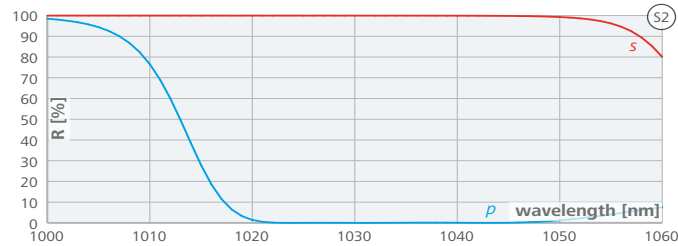
- S2: Coating 141303**  
 HRs,p (22.5°, 1030–1050 nm) > 99.8 %  
 Rs,p (22.5°, 900–980 nm) < 5 %  
**S1: Coating 141306**  
 ARs,p (22.5°, 900–1000 nm) < 0.2 %



Substrate Dimensions	No.	Imperfections	Item #	Price
Ø 12.7 mm   t 3.05 mm	A3	5/ 1 x 0.04	142321	258 €
Ø 25.0 mm   t 3.05 mm	B3	5/ 3 x 0.04	142320	582 €

### Thin Film Polarizer 45°, 1030 nm

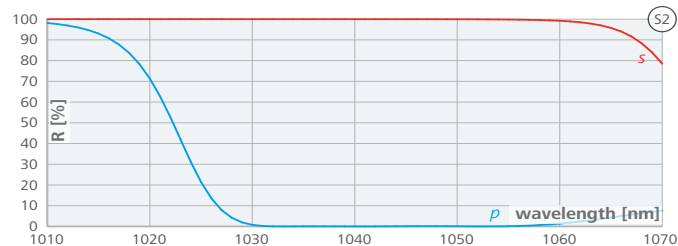
- S2: Coating 141254**  
 TFP (45°\*, 1030 nm) Rs > 99.9 % Rp < 2 %  
 \*specifications will be achieved by ±2° angle adjustment  
**S1: Coating 141268**  
 ARp (45°, 1020–1050 nm) < 0.1 %



Substrate Dimensions	No.	Imperfections	Item #	Price
Ø 25.0 mm   t 3.05 mm	B3	5/ 3 x 0.04	141531	407 €

### Thin Film Polarizer 45°, 1042 nm

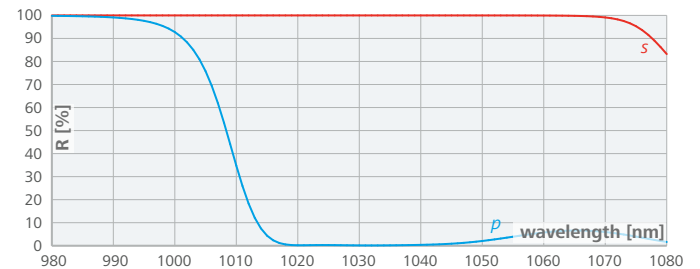
- S2: Coating 141259**  
 TFP (45°\*, 1042 nm) Rs > 99.9 % Rp < 2 %  
 \*specifications will be achieved by ±2° angle adjustment  
**S1: Coating 141268**  
 ARp (45°, 1020–1050 nm) < 0.1 %



Substrate Dimensions	No.	Imperfections	Item #	Price
Ø 25.0 mm   t 3.05 mm	B3	5/ 3 x 0.04	141532	407 €

### Thin Film Polarizer 56°, 1030 nm

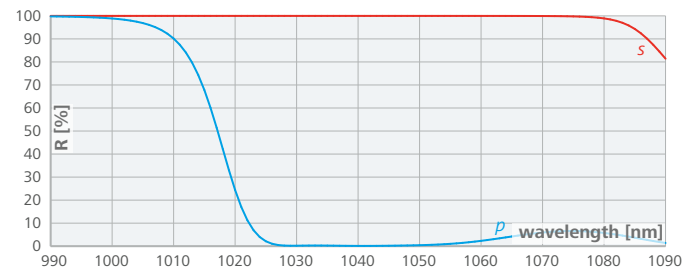
- S2: Coating 141262**  
 TFP (56°\*, 1030 nm) Rs > 99.9 % Rp < 2 %  
 \*specifications will be achieved by ±2° angle adjustment  
**S1: Uncoated; Brewster angle → Rp (56°) ~ 0 %**



Substrate Dimensions	No.	Imperfections	Item #	Price
Ø 25.0 mm   t 3.05 mm	B3	5/ 3 x 0.04	141533	345 €

### Thin Film Polarizer 56°, 1042 nm

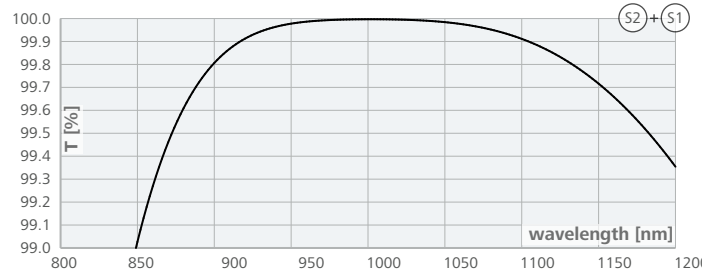
- S2: Coating 141264**  
 TFP (56°\*, 1042 nm) Rs > 99.9 % Rp < 2 %  
 \*specifications will be achieved by ±2° angle adjustment  
**S1: Uncoated; Brewster angle → Rp (56°) ~ 0 %**



Substrate Dimensions	No.	Imperfections	Item #	Price
Ø 25.0 mm   t 3.05 mm	B3	5/ 3 x 0.04	141534	345 €

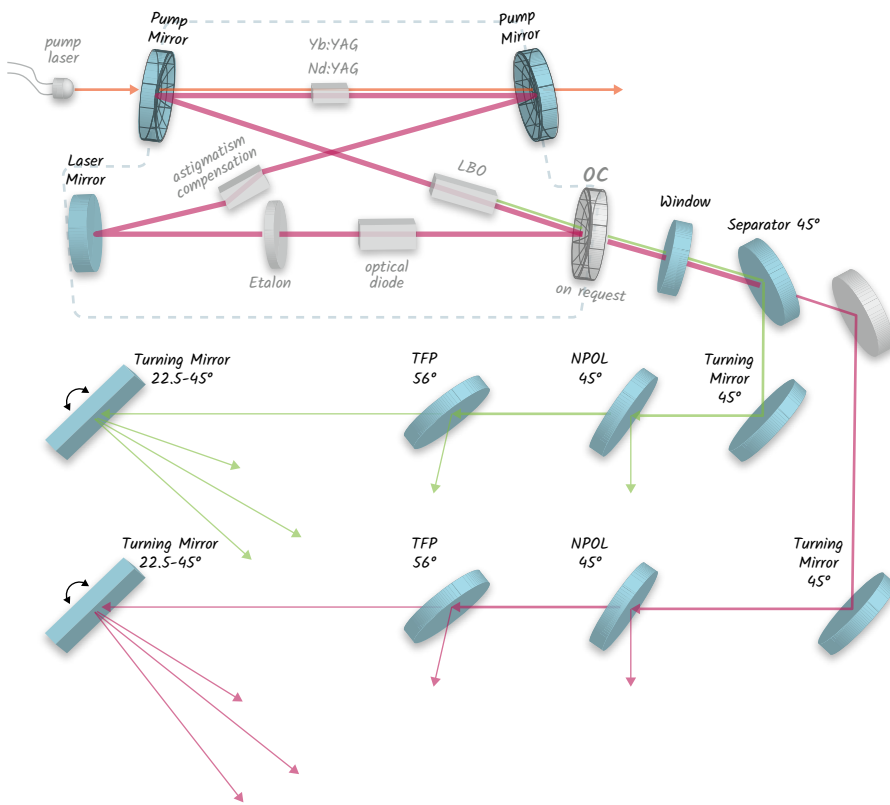
### Window 0°

- S2+S1: Coating 141184**  
 AR (0°, 950–1050 nm) < 0.2 %



Substrate Dimensions	No.	Imperfections	Item #	Price
Ø 12.7 mm   t 1 mm	A2	5/ 1 x 0.04	141932	124 €
Ø 25.0 mm   t 1 mm	B2	5/ 3 x 0.04	141935	230 €

# cw/ns-Laser [1030–1064 nm]

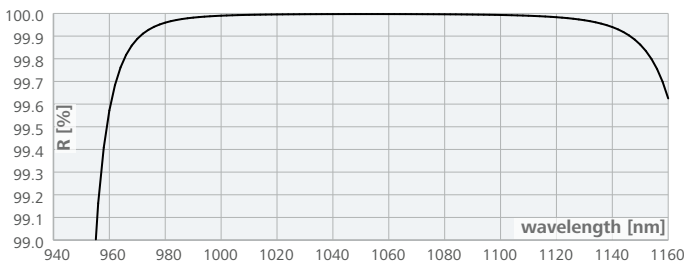
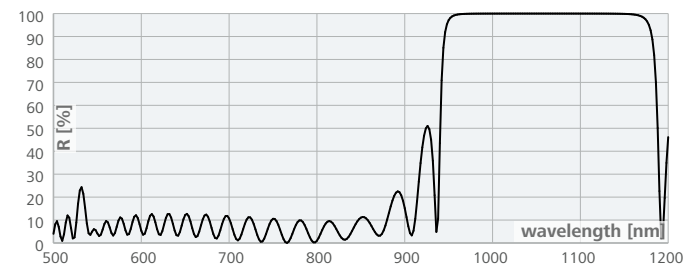


- Laser Mirror 0° ..... 117
- Pump Mirror 0° ..... 117
- Turning Mirror 22.5–45°, 1030–1064 nm ..... 118
- Turning Mirror 22.5–45°, 515–532 nm ..... 118
- Turning Mirror 45°, 1030–1064 nm ..... 118
- Turning Mirror 45°, 515–532 nm ..... 118
- Turning Mirror 45°, 343+515+1030 nm ..... 118
- Turning Mirror 45°, 355+532+1064 nm ..... 119
- Non-Polarizing Beamsplitter 45°, 1030 nm ..... 119
- Non-Polarizing Beamsplitter 45°, 515 nm ..... 119
- Non-Polarizing Beamsplitter 45°, 532 nm ..... 120
- Separator 45°, 515–532/1030–1064 nm ..... 120
- Separator 45°, 1030/515 nm ..... 120
- Separator 45°, 1064/532 nm ..... 120
- Separator 45°, p-pol. 343/515/1030 nm ..... 121
- Separator 45°, p-pol. 355/532/1064 nm ..... 121
- Separator 45°, s-pol. 343–355/515–532/  
1030–1064 nm ..... 121
- Thin Film Polarizer 56°, 1030 nm ..... 122
- Thin Film Polarizer 56°, 1064 nm ..... 122
- Thin Film Polarizer 56°, 515 nm ..... 122
- Thin Film Polarizer 56°, 532 nm ..... 122
- Window 0° ..... 122

For optics not specified here, please visit [www.layertec.de](http://www.layertec.de), contact us at [info@layertec.de](mailto:info@layertec.de) or call us at +49 (0)36453 744 0.

## Laser Mirror 0°

**Coating 141321**  
HRs,p (0–10°, 1030–1064 nm) > 99.95 %



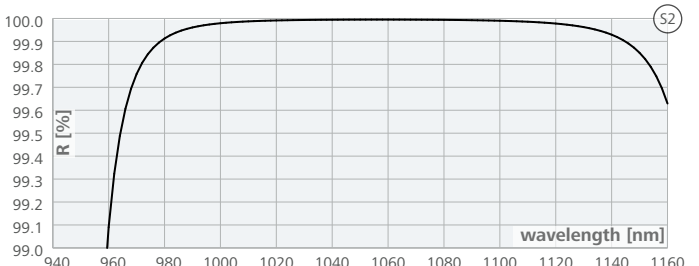
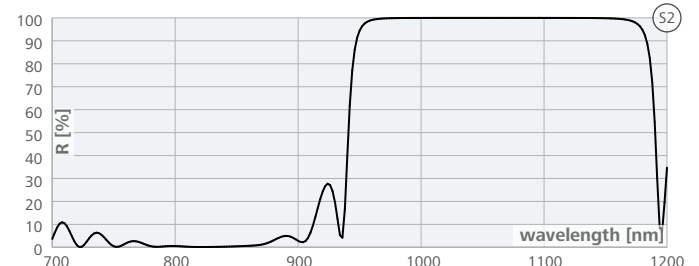
**LIDT**  
6/ 50J/cm<sup>2</sup>; 1064 nm; 7 ns; Ø270 µm LAYERTEC

Substrate Dimensions	No.	Imperfections	Item #	Price
Ø 12.7 mm   t6.35 mm	A4	5/ 1x0.04	141864	105 €
Ø 25.0 mm   t6.35 mm	B4	5/ 3x0.04	141868	143 €
Ø 50.0 mm   t9.5 mm	C3	5/ 4x0.063	141866	522 €

## Pump Mirror 0°

**S2: Coating 141325**  
HRs,p (0–10°, 1030–1064 nm) > 99.95 %  
Rs,p (0–10°, 808 nm) < 2 %

**S1: Coating 141355**  
ARs,p (0–10°, 808 nm) < 0.2 %

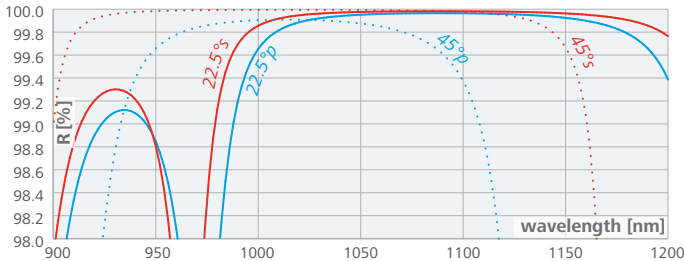


**LIDT**  
6/ 30J/cm<sup>2</sup>; 1064 nm; 7 ns; Ø270 µm LAYERTEC

Substrate Dimensions	No.	Imperfections	Item #	Price
Ø 12.7 mm   t6.35 mm	A4	5/ 1x0.04	141877	146 €
Ø 25.0 mm   t6.35 mm	B4	5/ 3x0.04	141881	222 €

**Turning Mirror 22.5–45°, 1 030 – 1 064 nm**

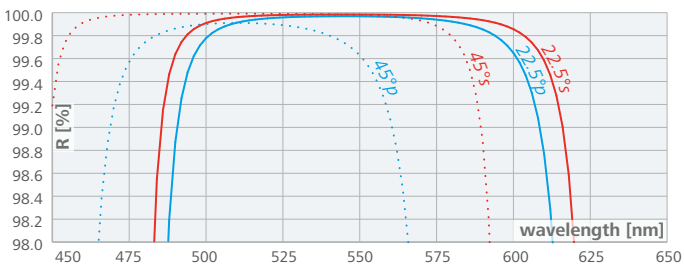
**Coating 141496**  
Ag+ multilayer  
HRs,p (22.5–45°, 1 030 – 1 064 nm) > 99.7 %  
for application outside the resonator  
no transmission @ VIS/NIR



Substrate Dimensions	No.	Imperfections	Item #	Price
Ø 25.0 mm   t 6.35 mm	B4	5/ 3 x 0.04	141942	138 €
Ø 50.0 mm   t 9.5 mm	C3	5/ 4 x 0.063	141945	504 €
25 x 25 mm   t 6.35 mm	K2	5/ 3 x 0.04	141954	174 €

**Turning Mirror 22.5–45°, 515 – 532 nm**

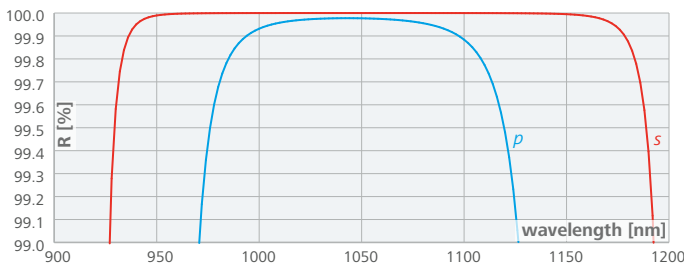
**Coating 141497**  
Ag+ multilayer  
HRs,p (22.5–45°, 515 – 532 nm) > 99.7 %  
for application outside the resonator  
no transmission @ VIS/NIR



Substrate Dimensions	No.	Imperfections	Item #	Price
Ø 25.0 mm   t 6.35 mm	B4	5/ 3 x 0.04	141949	138 €
25 x 25 mm   t 6.35 mm	K2	5/ 3 x 0.04	141956	174 €

**Turning Mirror 45°, 1 030 – 1 064 nm**

**Coating 141327**  
HRs,p (45°, 1 030 – 1 064 nm) > 99.95 %

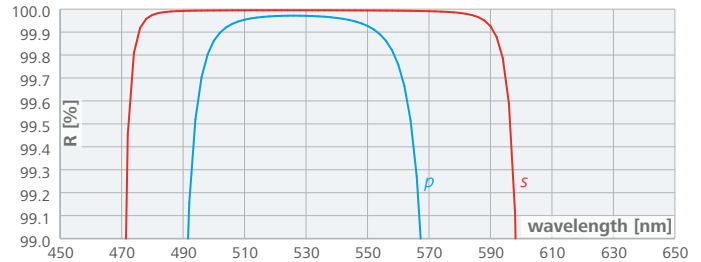


**LIDT**  
6/ 50 J/cm<sup>2</sup>; 1064 nm; 7 ns; Ø 270 µm LAYERTEC

Substrate Dimensions	No.	Imperfections	Item #	Price
Ø 12.7 mm   t 6.35 mm	A4	5/ 1 x 0.04	141896	105 €
Ø 25.0 mm   t 6.35 mm	B4	5/ 3 x 0.04	141500	143 €
Ø 50.0 mm   t 9.5 mm	C3	5/ 4 x 0.063	141904	522 €
25 x 25 mm   t 6.35 mm	K2	5/ 3 x 0.04	141953	183 €

**Turning Mirror 45°, 515 – 532 nm**

**Coating 141329**  
HRs,p (45°, 515 – 532 nm) > 99.9 %

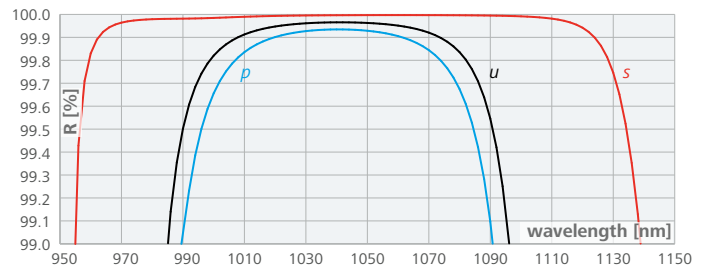
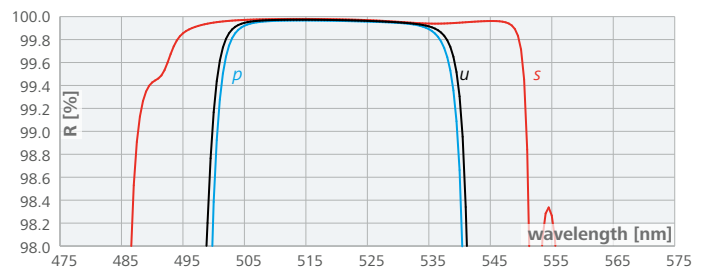
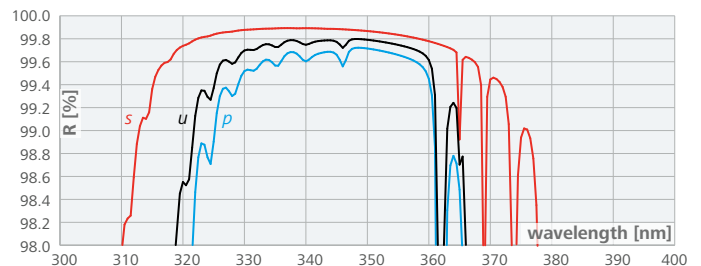


**LIDT**  
6/ 10 J/cm<sup>2</sup>; 532 nm; 7 ns; 10 Hz; Ø 270 µm LAYERTEC

Substrate Dimensions	No.	Imperfections	Item #	Price
Ø 25.0 mm   t 6.35 mm	B4	5/ 3 x 0.04	141946	138 €
25 x 25 mm   t 6.35 mm	K2	5/ 3 x 0.04	141955	174 €

**Turning Mirror 45°, 343+515+1 030 nm**

**Coating 128809**  
HRu (45°, 343 nm) > 99.4 %  
HRu (45°, 515 nm) > 99.8 %  
HRu (45°, 1030 nm) > 99.9 %

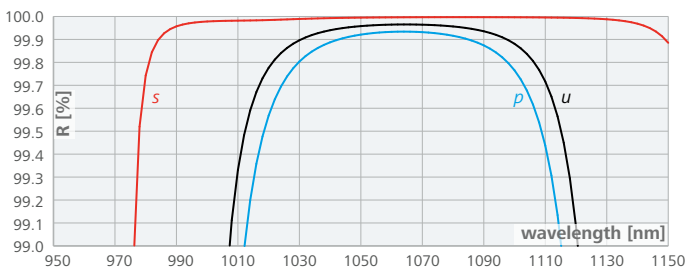
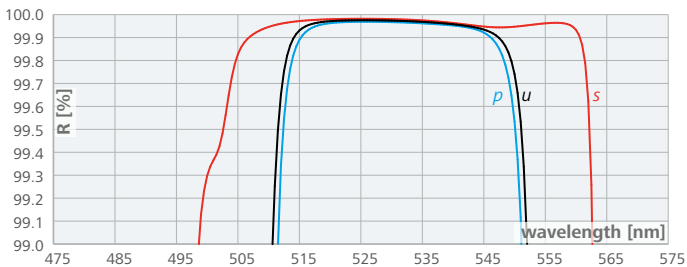
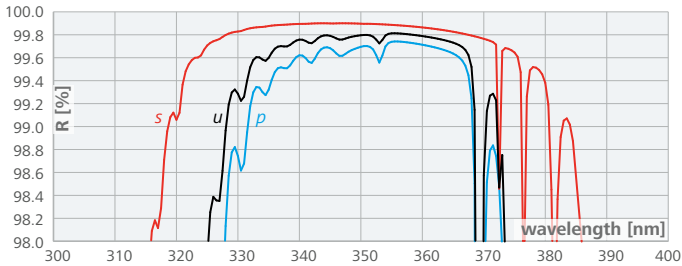


Substrate Dimensions	No.	Imperfections	Item #	Price
Ø 25.0 mm   t 6.35 mm	B4	5/ 2 x 0.04	128931	467 €



### Turning Mirror 45°, 355+532+1 064 nm

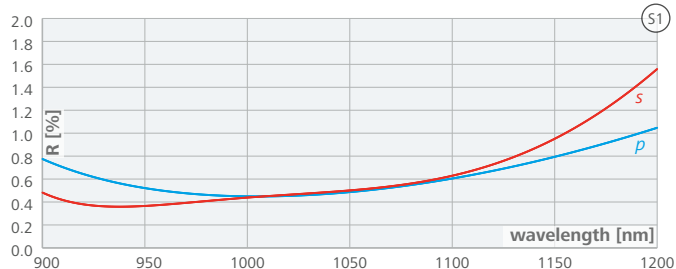
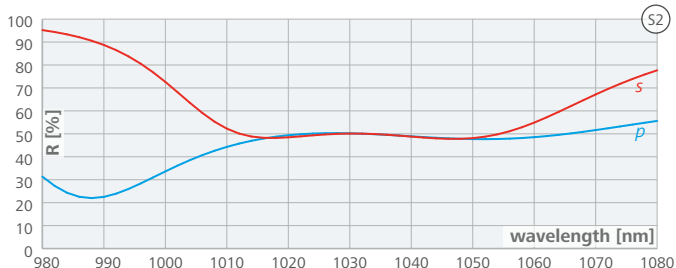
**Coating 115420**  
**HRu (45°, 355 nm) > 99.4 %**  
**HRu (45°, 532 nm) > 99.8 %**  
**HRu (45°, 1 064 nm) > 99.8 %**



Substrate Dimensions	No.	Imperfections	Item #	Price
Ø 25.0 mm   t 6.35 mm	B4	5/ 2 x 0.04	110837	467 €

### Non-Polarizing Beamsplitter 45°, 1 030 nm

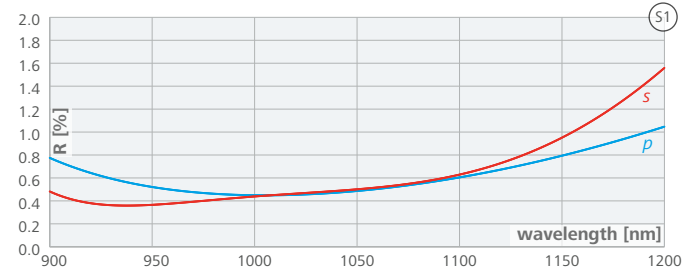
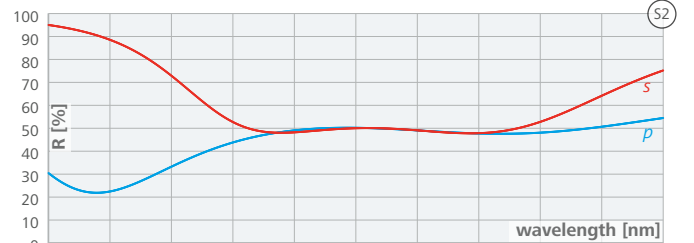
**S2: Coating 141335**  
**PRs,p (45°, 1 030 nm) = 50 (± 3) %**  
**|Rs - Rp| < 4 %**  
**S1: Coating 141331**  
**ARs,p (45°, 1 030–1 064 nm) < 0.7 %**  
**|Rs - Rp| < 0.2 %**



Substrate Dimensions	No.	Imperfections	Item #	Price
Ø 25.0 mm   t 3.05 mm	B3	5/ 3 x 0.04	141604	270 €

### Non-Polarizing Beamsplitter 45°, 1 064 nm

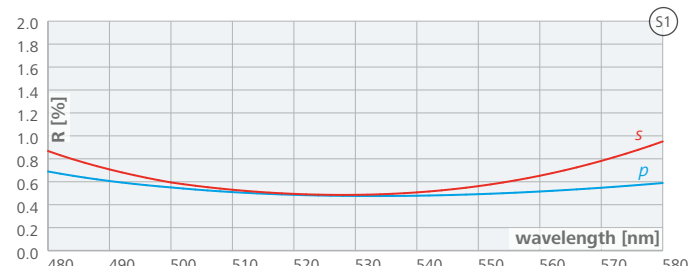
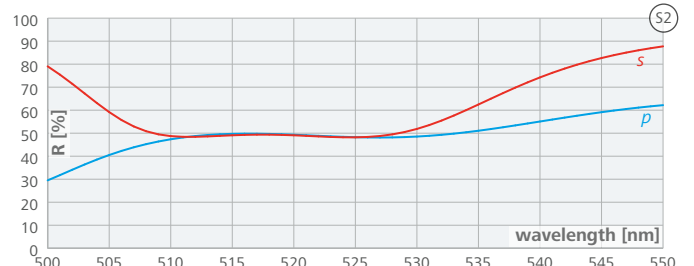
**S2: Coating 141338**  
**PRs,p (45°, 1 064 nm) = 50 (± 3) %**  
**|Rs - Rp| < 4 %**  
**S1: Coating 141331**  
**ARs,p (45°, 1 030–1 064 nm) < 0.7 %**  
**|Rs - Rp| < 0.2 %**



Substrate Dimensions	No.	Imperfections	Item #	Price
Ø 25.0 mm   t 3.05 mm	B3	5/ 3 x 0.04	141607	270 €

### Non-Polarizing Beamsplitter 45°, 515 nm

**S2: Coating 141344**  
**PRs,p (45°, 515 nm) = 50 (± 3) %**  
**|Rs - Rp| < 4 %**  
**S1: Coating 141341**  
**ARs,p (45°, 515–532 nm) < 0.7 %**  
**|Rs - Rp| < 0.2 %**



Substrate Dimensions	No.	Imperfections	Item #	Price
Ø 25.0 mm   t 3.05 mm	B3	5/ 3 x 0.04	141608	270 €

### Non-Polarizing Beamsplitter 45°, 532 nm

S2: Coating 141346

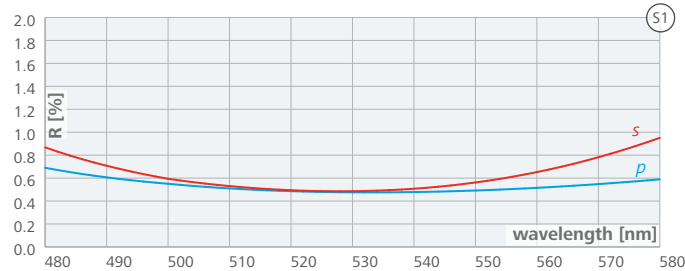
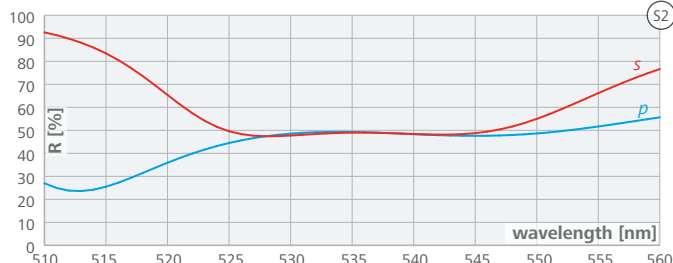
PRs,p (45°, 532 nm) = 50 (±3)%

|Rs - Rp| < 4%

S1: Coating 141341

ARs,p (45°, 515–532 nm) < 0.7%

|Rs - Rp| < 0.2%



Substrate Dimensions	No.	Imperfections	Item #	Price
Ø 25.0 mm   t 3.05 mm	B3	5/ 3 x 0.04	141609	270 €

### Separator 45°, 1 030/515 nm

S2: Coating 159375

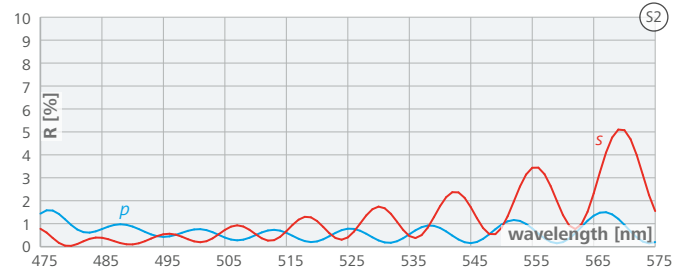
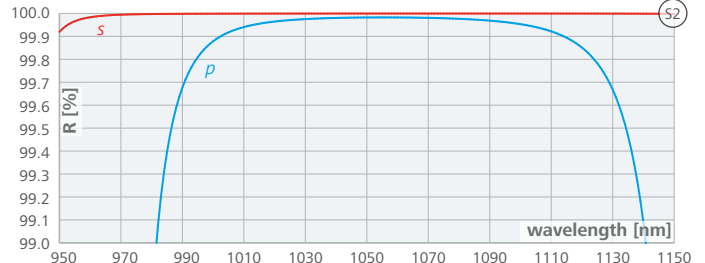
HRs,p (45°, 1 030 nm) > 99.9%

Rs,p (45°, 515 nm) < 3%

S1: Coating 141341

ARs,p (45°, 515 nm) < 0.7%

|Rs - Rp| < 0.2%



Substrate Dimensions	No.	Imperfections	Item #	Price
Ø 25.0 mm   t 6.35 mm	B4	5/ 2 x 0.04	160937	390 €

### Separator 45°, 515–532/1 030–1 064 nm

S2: Coating 141359

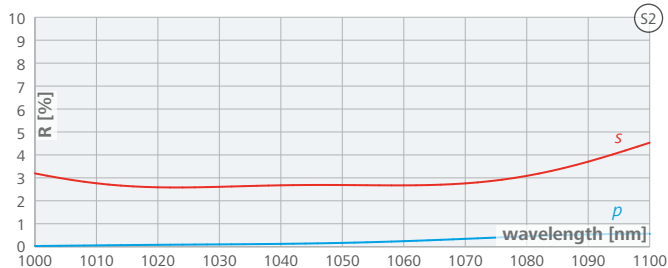
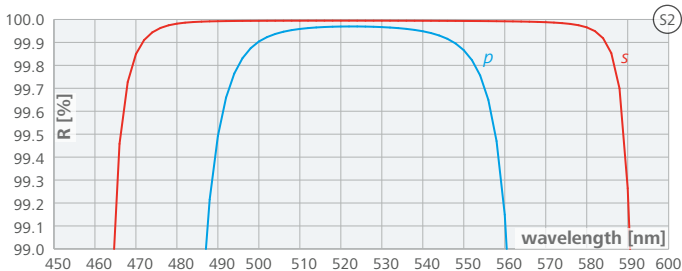
HRs,p (45°, 515–532 nm) > 99.8%

Rs (45°, 1 030–1 064 nm) < 5%

Rp (45°, 1 030–1 064 nm) < 2%

S1: Coating 141377

ARs,p (45°, 1 030–1 064 nm) < 0.7%



Substrate Dimensions	No.	Imperfections	Item #	Price
Ø 25.0 mm   t 3.05 mm	B3	5/ 3 x 0.04	141892	216 €
Ø 25.0 mm   t 6.35 mm	B4	5/ 3 x 0.04	141895	200 €

### Separator 45°, 1 064/532 nm

S2: Coating 159374

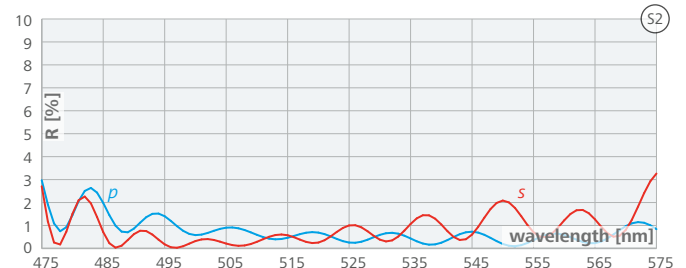
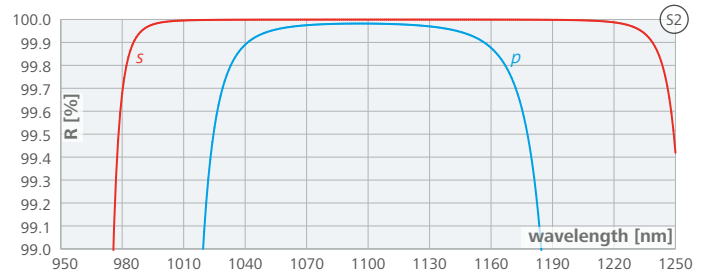
HRs,p (45°, 1 064 nm) > 99.9%

Rs,p (45°, 532 nm) < 3%

S1: Coating 141341

ARs,p (45°, 532 nm) < 0.7%

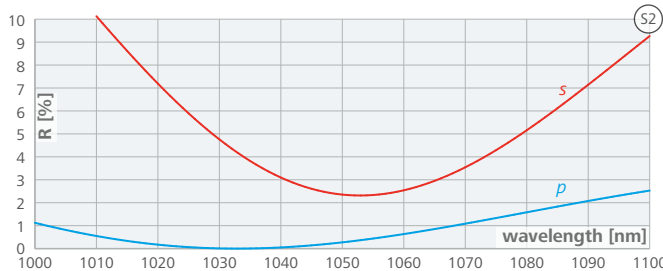
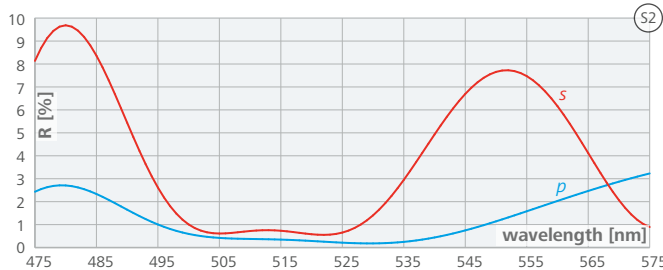
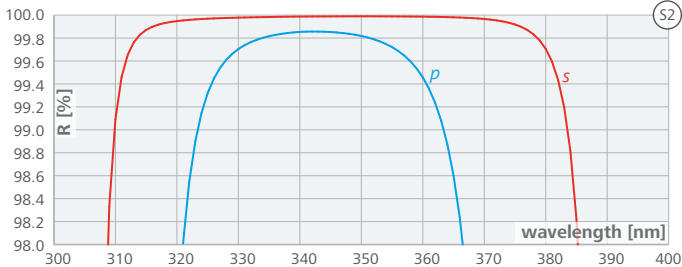
|Rs - Rp| < 0.2%



Substrate Dimensions	No.	Imperfections	Item #	Price
Ø 25.0 mm   t 6.35 mm	B4	5/ 2 x 0.04	160936	390 €

**Separator 45°, p-pol. 343/515/1030 nm**

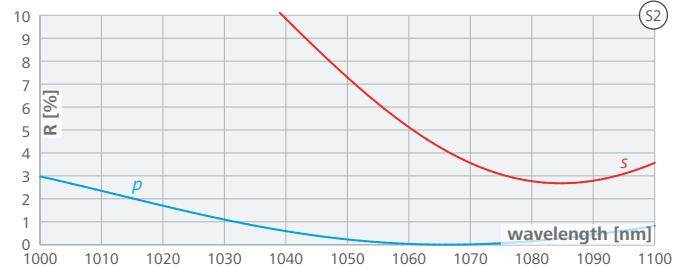
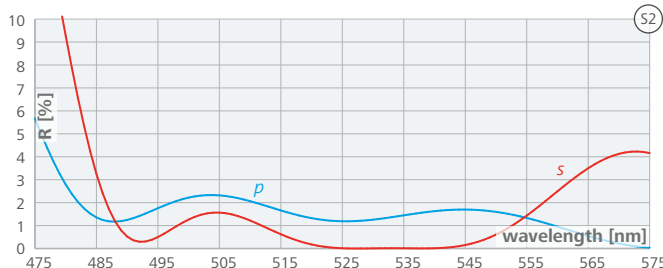
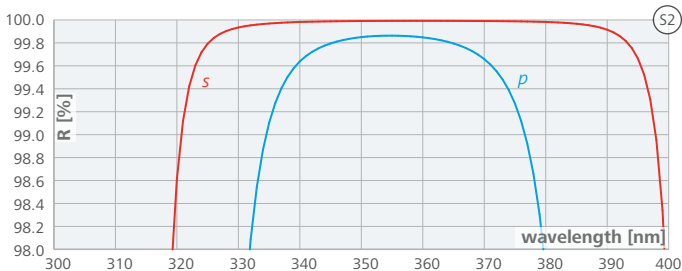
- S2: Coating 122334**  
 HRp (45°, 343 nm) > 99.0 %  
 Rs (45°, 515 nm) < 3 %  
 Rp (45°, 1030 nm) < 2 %
- S1: Coating 122335**  
 ARs (45°, 515 nm) < 0.5 %  
 ARp (45°, 1030 nm) < 0.5 %



Substrate Dimensions	No.	Imperfections	Item #	Price
Ø 25.0 mm   t 3.05 mm	B3	5/ 2x0.04	160935	370 €

**Separator 45°, p-pol. 355/532/1064 nm**

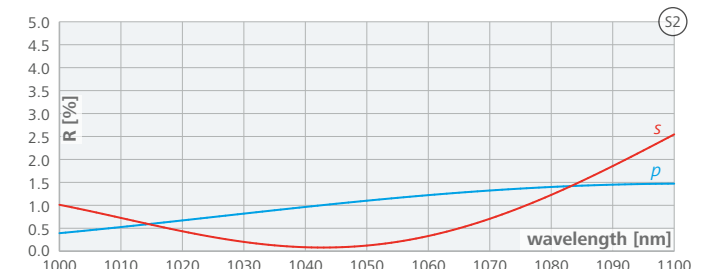
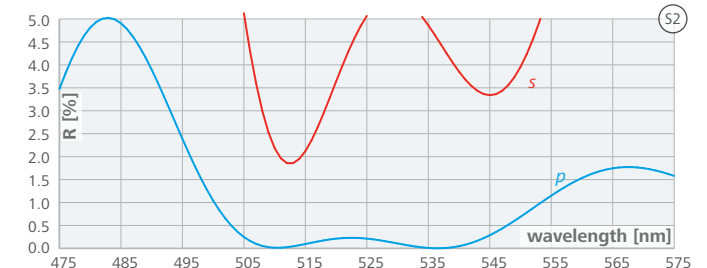
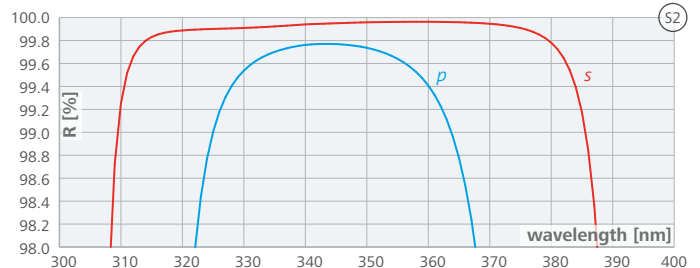
- S2: Coating 115203**  
 HRp (45°, 355 nm) > 99.5 %  
 Rs (45°, 532 nm) < 5 %  
 Rp (45°, 1064 nm) < 5 %
- S1: Coating 128506**  
 ARs (45°, 535 nm) < 0.5 %  
 ARp (45°, 1064 nm) < 0.5 %



Substrate Dimensions	No.	Imperfections	Item #	Price
Ø 25.0 mm   t 3.05 mm	B3	5/ 2x0.04	109816	370 €

**Separator 45°, s-pol. 343-355/515-532/1030-1064 nm**

- S2: Coating 115258**  
 HRs (45°, 343-358 nm) > 99.9 %  
 Rp (45°, 515-532 nm) < 1 %  
 Rs (45°, 1030-1064 nm) < 1 %
- S1: Coating 116338**  
 ARp (45°, 515-535 nm) < 0.3 %  
 ARs (45°, 1030-1064 nm) < 0.2 %



Substrate Dimensions	No.	Imperfections	Item #	Price
Ø 25.0 mm   t 3.65 mm	B4	5/ 2x0.04	116540	442 €

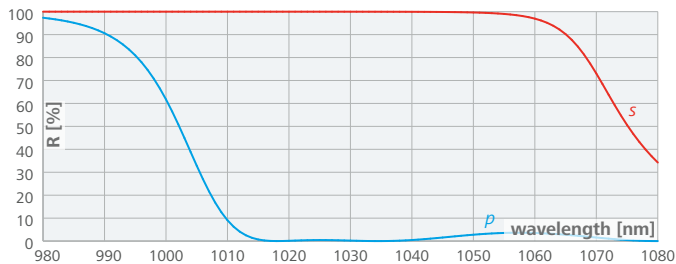
### Thin Film Polarizer 56°, 1030 nm

**S2: Coating 141352**

TFP (56°\*, 1030 nm)  $R_s > 99.9\%$   $R_p < 2\%$

\*specifications will be achieved by  $\pm 2^\circ$  angle adjustment

**S1: Uncoated; Brewster angle  $\rightarrow R_p(56^\circ) \sim 0\%$**



Substrate Dimensions	No.	Imperfections	Item #	Price
Ø 25.0 mm   t 3.05 mm	B3	5/ 3 x 0.04	141535	345 €

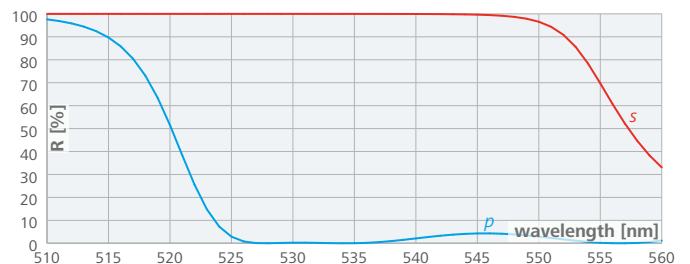
### Thin Film Polarizer 56°, 532 nm

**S2: Coating 141351**

TFP (56°\*, 532 nm)  $R_s > 99.9\%$   $R_p < 2\%$

\*specifications will be achieved by  $\pm 2^\circ$  angle adjustment

**S1: Uncoated; Brewster angle  $\rightarrow R_p(56^\circ) \sim 0\%$**



Substrate Dimensions	No.	Imperfections	Item #	Price
Ø 25.0 mm   t 3.05 mm	B3	5/ 3 x 0.04	141539	345 €

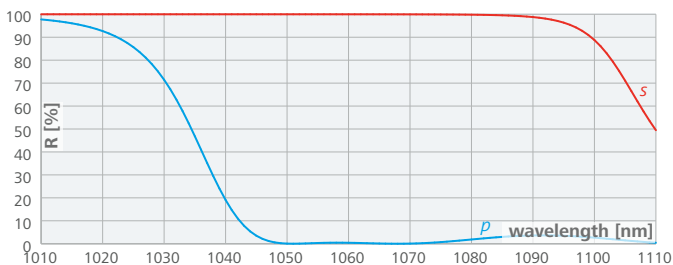
### Thin Film Polarizer 56°, 1064 nm

**S2: Coating 141353**

TFP (56°\*, 1064 nm)  $R_s > 99.9\%$   $R_p < 2\%$

\*specifications will be achieved by  $\pm 2^\circ$  angle adjustment

**S1: Uncoated; Brewster angle  $\rightarrow R_p(56^\circ) \sim 0\%$**



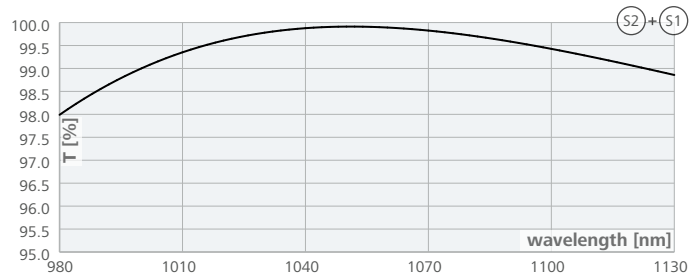
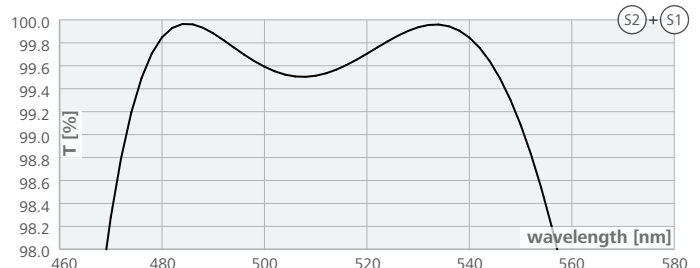
Substrate Dimensions	No.	Imperfections	Item #	Price
Ø 25.0 mm   t 3.05 mm	B3	5/ 3 x 0.04	141536	345 €

### Window 0°

**S2+S1: Coating 141348**

AR (0°, 515–532 nm)  $< 0.5\%$

AR (0°, 1030–1064 nm)  $< 0.3\%$



Substrate Dimensions	No.	Imperfections	Item #	Price
Ø 12.7 mm   t 1 mm	A2	5/ 1 x 0.04	141890	126 €
Ø 25.0 mm   t 3.05 mm	B3	5/ 3 x 0.04	141885	156 €

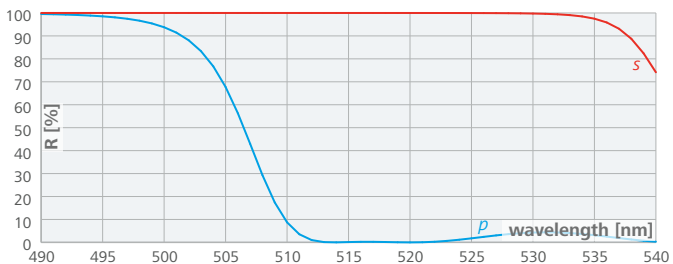
### Thin Film Polarizer 56°, 515 nm

**S2: Coating 141350**

TFP (56°\*, 515 nm)  $R_s > 99.9\%$   $R_p < 2\%$

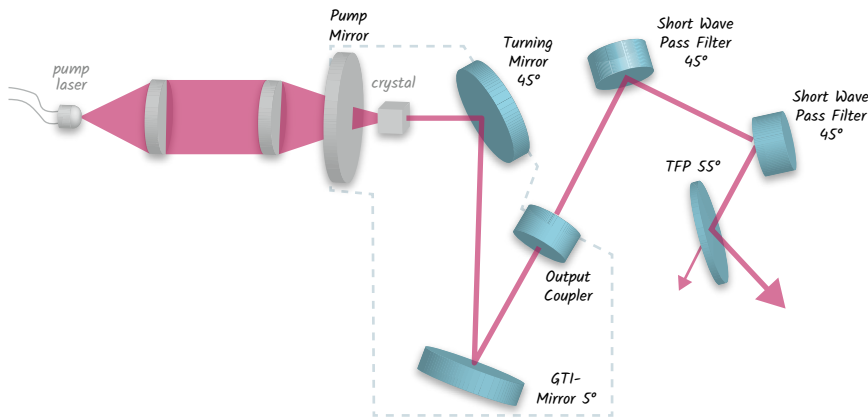
\*specifications will be achieved by  $\pm 2^\circ$  angle adjustment

**S1: Uncoated; Brewster angle  $\rightarrow R_p(56^\circ) \sim 0\%$**



Substrate Dimensions	No.	Imperfections	Item #	Price
Ø 25.0 mm   t 3.05 mm	B3	5/ 3 x 0.04	141537	345 €

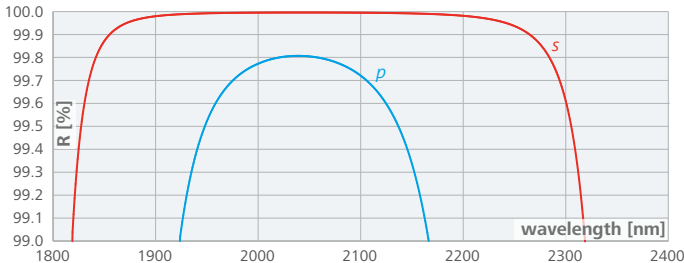
# 2 μm [Ho:YAG|Tm:YAG]



- Turning Mirror 45° ..... 123
- Output Coupler 70 % ..... 123
- Output Coupler 80 % ..... 123
- Output Coupler 95 % ..... 124
- GTI-Mirror 5°, -500 fs<sup>2</sup> ..... 124
- Short Wave Pass Filter 45° ..... 124
- Thin Film Polarizer 55° ..... 124

## Turning Mirror 45°

Coating 160406 on Fused Silica IR grade  
HRs (45°, 2090 nm) > 99.9 %

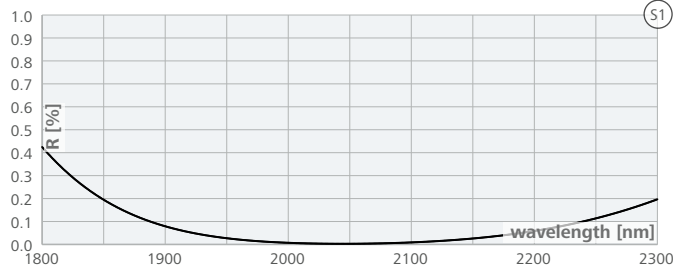
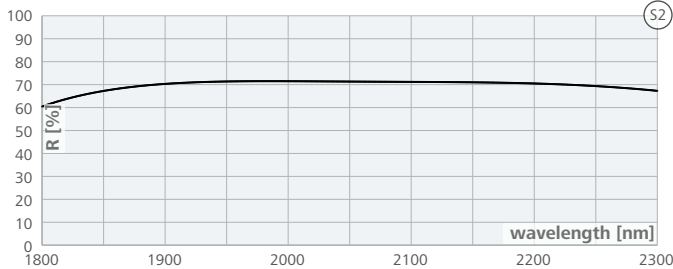


Substrate Dimensions	No.	Imperfections	Item #	Price
Ø 12.7 mm   t 6.35 mm	A4b	5/ 2 x 0.025	103180	168 €
Ø 25.0 mm   t 6.35 mm	B4b	5/ 2 x 0.04	160659	360 €

## Output Coupler 70 %

S2: Coating 113886 on Fused Silica IR grade  
PR (0°, 2010 – 2 100 nm) = 70(±2) %

S1: Coating 116213  
AR (0°, 2010 – 2 100 nm) < 0.25 %

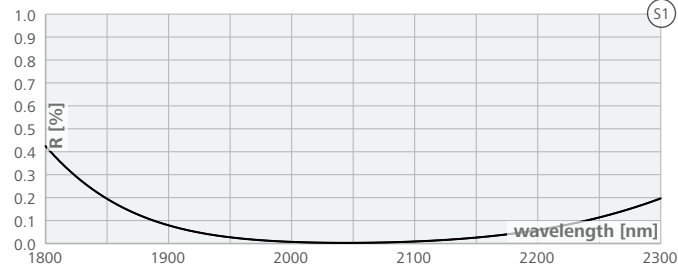
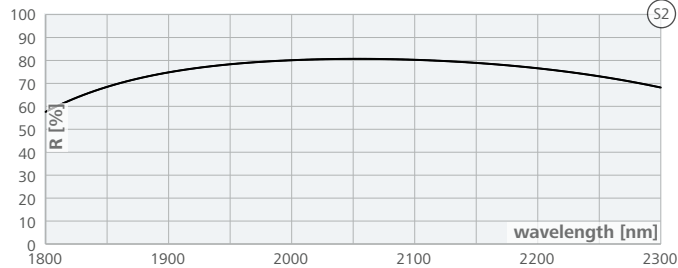


Substrate Dimensions	No.	Imperfections	Item #	Price
Ø 12.7 mm   t 6.35 mm	A4b	5/ 2 x 0.025	102671	147 €

## Output Coupler 80 %

S2: Coating 160390 on Fused Silica IR grade  
PR (0°, 2010 – 2 100 nm) = 80(±2) %

S1: Coating 116213  
AR (0°, 2010 – 2 100 nm) < 0.25 %



Substrate Dimensions	No.	Imperfections	Item #	Price
Ø 12.7 mm   t 6.35 mm	A4b	5/ 2 x 0.025	100415	147 €

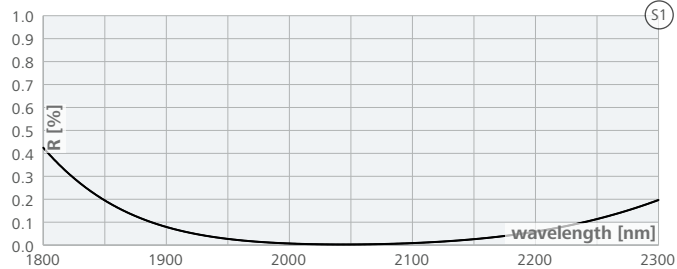
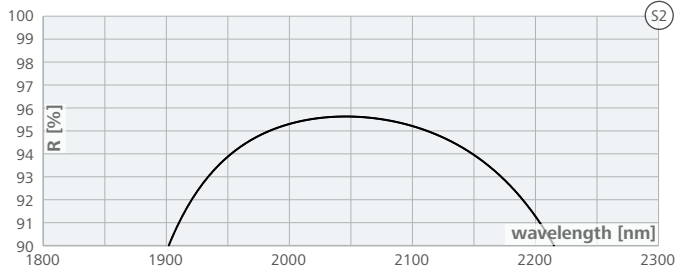
### Output Coupler 95 %

**S2: Coating 160391 on Fused Silica IR grade**

**PR (0°, 2010 – 2100 nm) = 95 (±1) %**

**S1: Coating 116213**

**AR (0°, 2010 – 2100 nm) < 0.25 %**



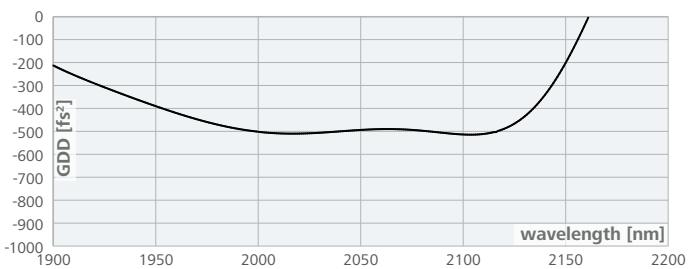
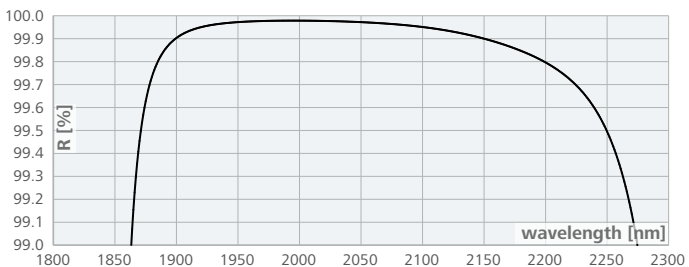
Substrate Dimensions	No.	Imperfections	Item #	Price
Ø 12.7 mm   t 6.35 mm	A4b	5/ 2 x 0.025	107781	147 €

### GTI-Mirror 5°, -500 fs<sup>2</sup>

**Coating 159365**

**HR (0–5°, 2010 – 2100 nm) > 99.9 %**

**GDD-R (0–5°, 2010 – 2100 nm) = -500 (±150) fs<sup>2</sup>**  
without GDD measurement



Substrate Dimensions	No.	Imperfections	Item #	Price
Ø 25.0 mm   t 6.35 mm	B4	5/ 2 x 0.04	160660	720 €

### Short Wave Pass Filter 45°

**S2: Coating 115311 on Fused Silica IR grade**

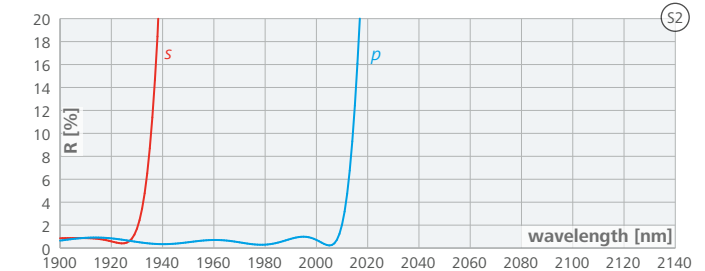
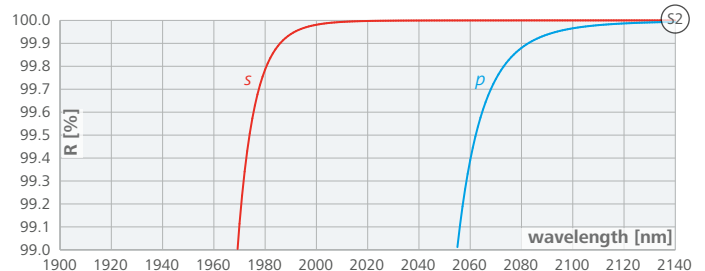
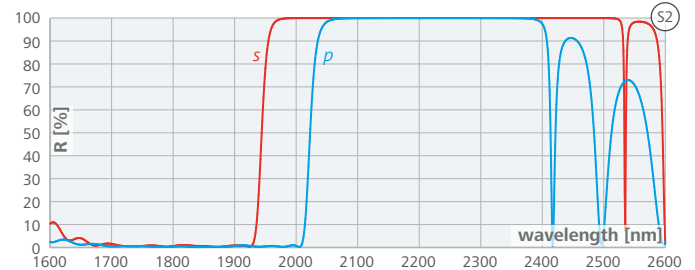
**HR<sub>s,p</sub> (45°\*, 2090 nm) > 99.8 %**

**Rs,p (45°\*, 1908 nm) < 3 %**

\*specifications will be achieved by ± 3° angle adjustment

**S1: Coating 123893**

**AR<sub>s,p</sub> (45°, 1908 nm) < 0.6 %**



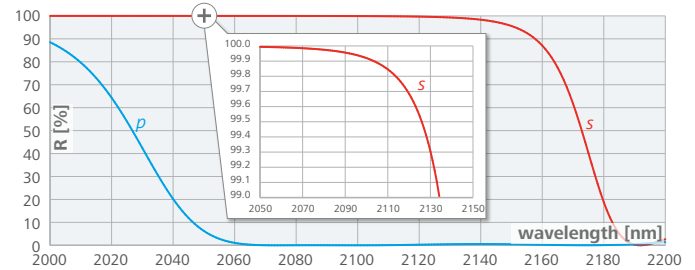
Substrate Dimensions	No.	Imperfections	Item #	Price
Ø 12.7 mm   t 6.35 mm	A4b	5/ 2 x 0.025	110072	420 €
Ø 25.0 mm   t 6.35 mm	B4b	5/ 3 x 0.04	112699	870 €

### Thin Film Polarizer 55°

**Coating 113900 on Fused Silica IR grade**

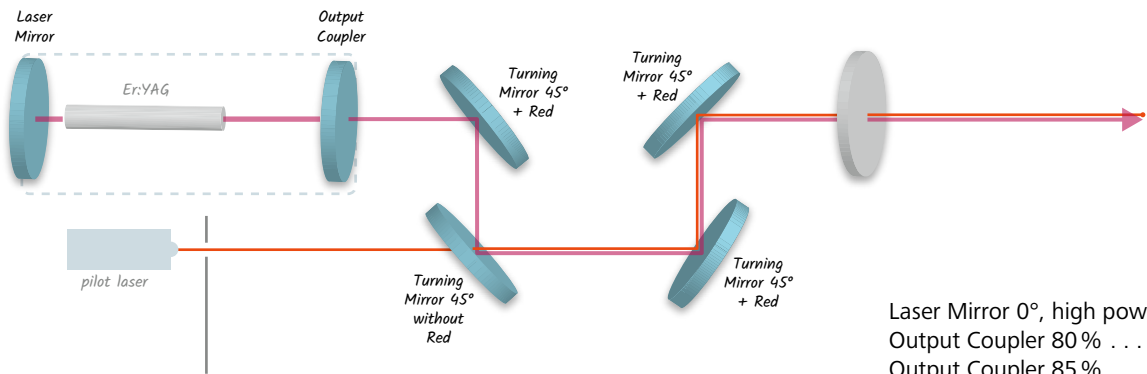
**TFP (55°\*, 2090 nm) R<sub>s</sub> > 99.9 % R<sub>p</sub> < 1 %**

\*specifications will be achieved by ± 3° angle adjustment



Substrate Dimensions	No.	Imperfections	Item #	Price
Ø 25.0 mm   t 3.0 mm	B3b	5/ 2 x 0.04	102787	557 €

# 3 μm [Er:YAG]

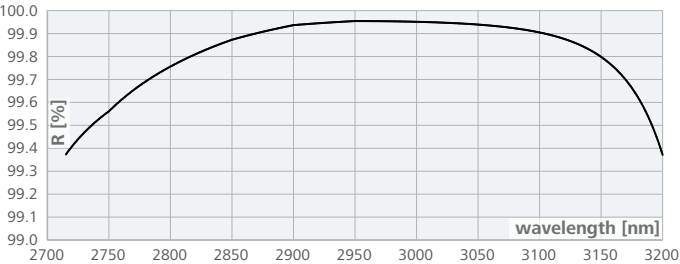


- Laser Mirror 0°, high power . . . . . 125
- Output Coupler 80 % . . . . . 125
- Output Coupler 85 % . . . . . 125
- Output Coupler 90 % . . . . . 126
- Turning Mirror 45°, Red R > 95% . . . . . 126
- Turning Mirror 45°, Red R < 20% . . . . . 126

For optics not specified here, please visit [www.layertec.de](http://www.layertec.de), contact us at [info@layertec.de](mailto:info@layertec.de) or call us at +49 (0)36453 744 0.

## Laser Mirror 0°, high power

Coating 160428 on Sapphire  
HR (0°, 2940 nm) > 99.8 %

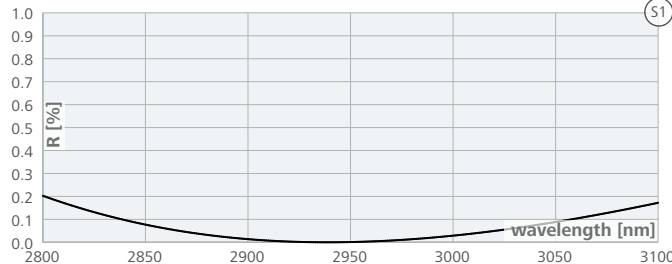
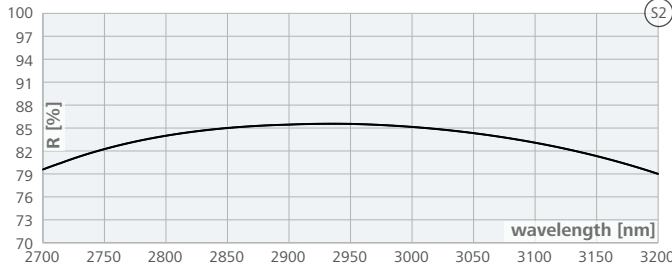


Substrate Dimensions	No.	Imperfections	Item #	Price
Ø 12.7 mm   t 3.0 mm	A3e	5/ 2 x 0.04	100417	177 €
Ø 25.4 mm   t 3.0 mm	B3e	5/ 2 x 0.063	100418	320 €

## Output Coupler 85 %

S2: Coating 160425 on Sapphire  
PR (0°, 2940 nm) = 85 (±2) %

S1: Coating 120759  
AR (0°, 2940 nm) < 0.25 %

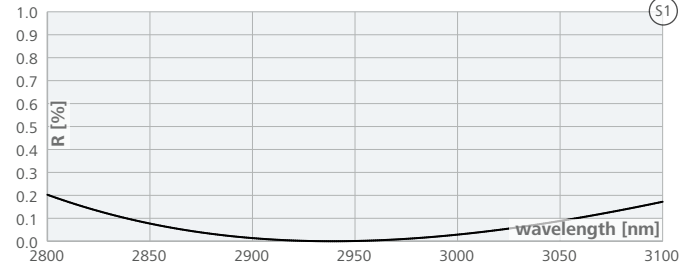
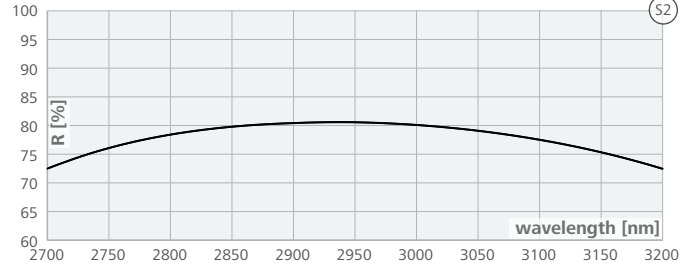


Substrate Dimensions	No.	Imperfections	Item #	Price
Ø 12.7 mm   t 3.0 mm	A3e	5/ 2 x 0.04	109581	177 €

## Output Coupler 80 %

S2: Coating 160426 on Sapphire  
PR (0°, 2940 nm) = 80 (±2) %

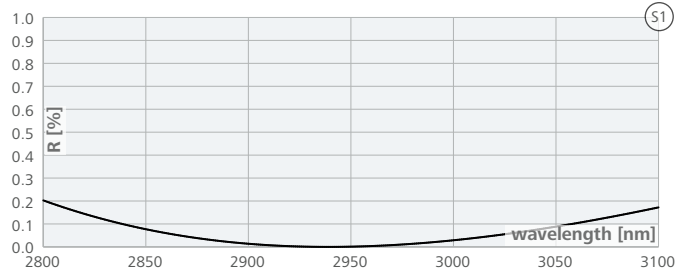
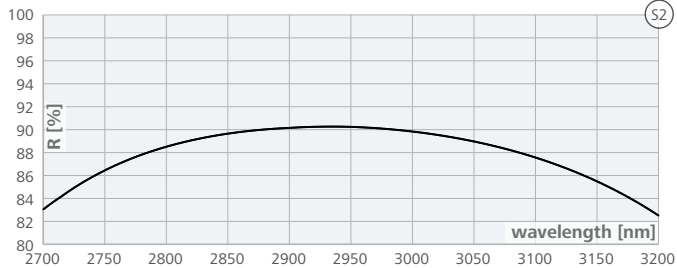
S1: Coating 120759  
AR (0°, 2940 nm) < 0.25 %



Substrate Dimensions	No.	Imperfections	Item #	Price
Ø 12.7 mm   t 3.0 mm	A3e	5/ 2 x 0.04	109753	177 €

**Output Coupler 90 %**

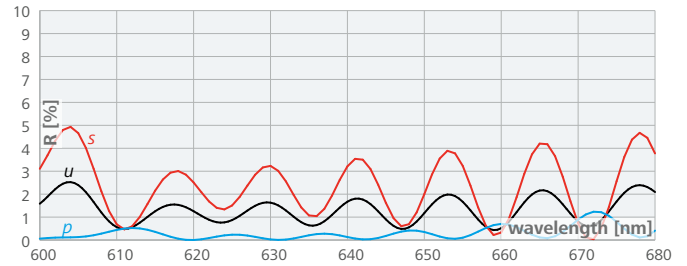
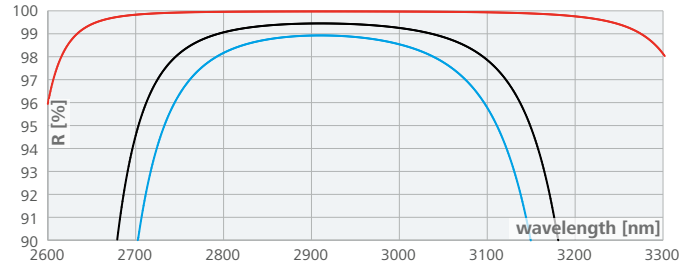
**S2: Coating 135719 on Sapphire**  
**PR (0°, 2940 nm) = 90 (±1) %**  
**S1: Coating 120759**  
**AR (0°, 2940 nm) < 0.25 %**



Substrate Dimensions	No.	Imperfections	Item #	Price
Ø 12.7 mm   t 3.0 mm	A3e	5/ 2 x 0.04	100419	177 €

**Turning Mirror 45°, Red R < 20%**

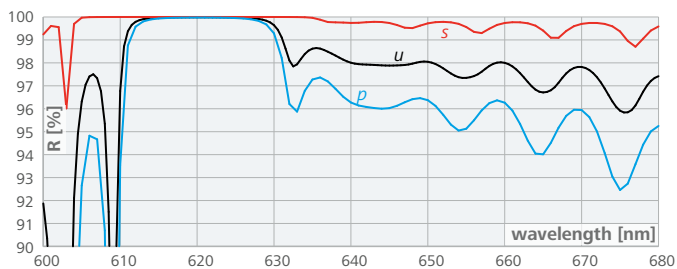
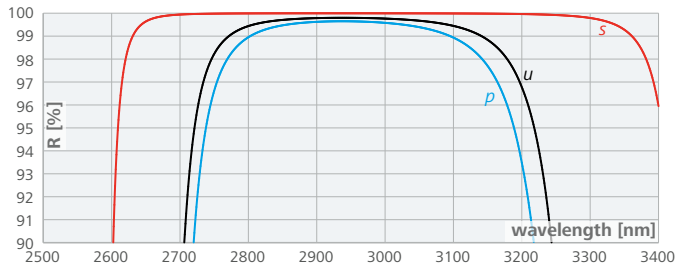
**Coating 115132 on Sapphire**  
**HRu (45°, 2940 nm) > 99 %**  
**Ru (45°, 635–655 nm) < 20 %**



Substrate Dimensions	No.	Imperfections	Item #	Price
Ø 25.4 mm   t 3.0 mm	B3e	5/ 2 x 0.063	109093	320 €

**Turning Mirror 45°, Red R > 95%**

**Coating 113862**  
**HRu (45°, 2940 nm) > 99.5 %**  
**Ru (45°, 635–655 nm) > 95 %**



Substrate Dimensions	No.	Imperfections	Item #	Price
Ø 25.4 mm   t 3.05 mm	B3	5/ 2 x 0.063	160977	287 €

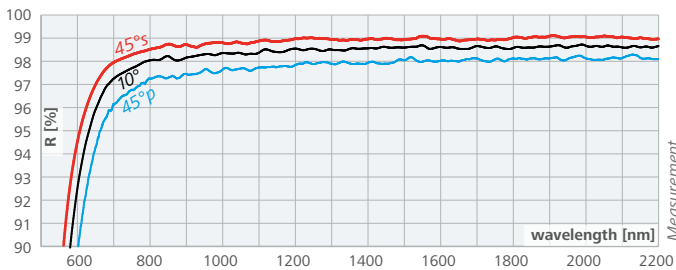


# Metallic Mirrors

- Unprotected Gold Mirror . . . . . 127
- Protected Gold Mirror . . . . . 127
- Protected Silver Mirror, 600–1000 nm . . . . . 127
- Protected Silver Mirror, 800–2000 nm . . . . . 128
- Protected Aluminum Mirror, UV-range . . . . . 128
- Protected Aluminum Mirror, UV-VIS-range . . . . . 128

## Unprotected Gold Mirror

**Coating 140770**  
**Au unprotected**  
**HR (0°, 800–20 000 nm) > 98 %**  
**HRs (45°, 800–20 000 nm) > 98 %**  
**HRp (45°, 800–20 000 nm) > 97 %**

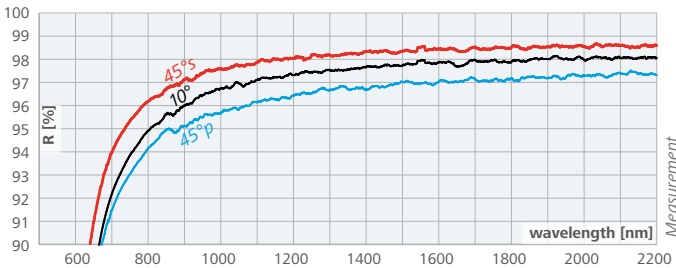


**LIDT**  
 6/ 0.5 J/cm<sup>2</sup>; 795 nm; 42 fs; 1 kHz; Ø80 µm WRCP Budapest

Substrate Dimensions	No.	Imperfections	Item #	Price
Ø 12.7 mm   t 6.35 mm	A4	5/ 2 x 0.025	142064	78 €
Ø 25.0 mm   t 6.35 mm	B4	5/ 2 x 0.04	142065	114 €
Ø 50.0 mm   t 9.5 mm	C3	5/ 6 x 0.04	142066	414 €
25 x 25 mm   t 6.35 mm	K2	5/ 2 x 0.04	142067	138 €

## Protected Gold Mirror

**Coating 140777**  
**Au + protection layer**  
**HR (0°, 800–4 000 nm) > 95 %**  
**HRs (45°, 800–4 000 nm) > 95 %**  
**HRp (45°, 800–4 000 nm) > 94 %**

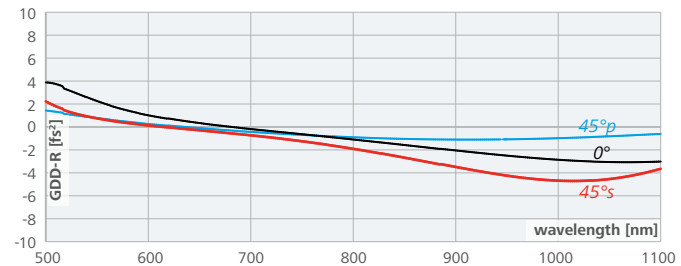
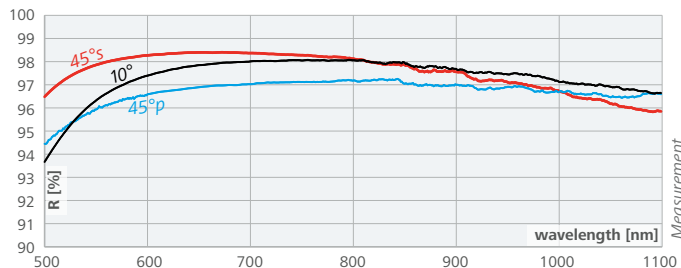


**LIDT**  
 6/ 0.2 J/cm<sup>2</sup>; 795 nm; 42 fs; 1 kHz; Ø80 µm WRCP Budapest

Substrate Dimensions	No.	Imperfections	Item #	Price
Ø 12.7 mm   t 6.35 mm	A4	5/ 2 x 0.025	142074	84 €
Ø 25.0 mm   t 6.35 mm	B4	5/ 2 x 0.04	142075	118 €
Ø 50.0 mm   t 9.5 mm	C3	5/ 6 x 0.04	142076	432 €
25 x 25 mm   t 6.35 mm	K2	5/ 2 x 0.04	142077	148 €

## Protected Silver Mirror, 600–1000 nm

**Coating 140780**  
**Ag + protection layer, fs-opt. 600–1 000 nm**  
**HR (0°, 600–1 000 nm) > 97 %**  
**HRs (45°, 600–1 000 nm) > 96 %**  
**HRp (45°, 600–1 000 nm) > 96 %**  
**|GDD-Rs,p (0–45°, 600–1 000 nm)| < 10 fs<sup>2</sup>**

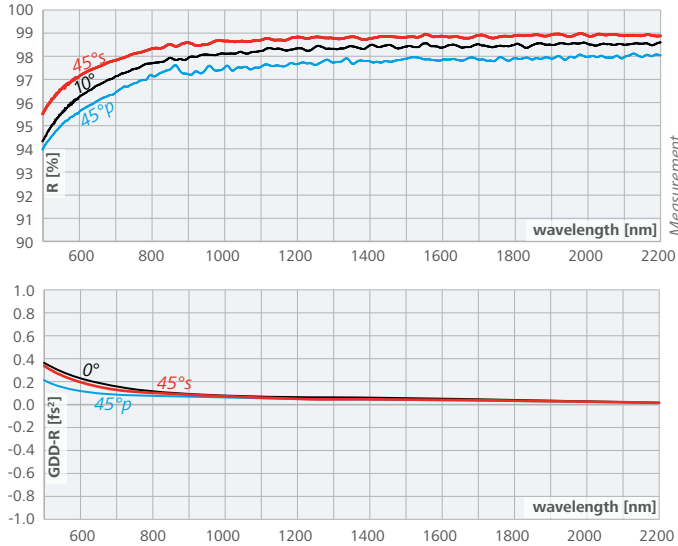


**LIDT**  
 6/ 5 J/cm<sup>2</sup>; 1 064 nm; 7 ns; 10 Hz; Ø480 µm LAYERTEC  
 6/ 0.7 J/cm<sup>2</sup>; 795 nm; 42 fs; 1 kHz; Ø80 µm WRCP Budapest

Substrate Dimensions	No.	Imperfections	Item #	Price
Ø 12.7 mm   t 6.35 mm	A4	5/ 2 x 0.025	142089	75 €
Ø 25.0 mm   t 6.35 mm	B4	5/ 2 x 0.04	142088	100 €
Ø 50.0 mm   t 9.5 mm	C3	5/ 6 x 0.04	142086	336 €
25 x 25 mm   t 6.35 mm	K2	5/ 2 x 0.04	142083	130 €

### Protected Silver Mirror, 800–2 000 nm

**Coating 140831**  
**Ag+protection layer, fs-opt. 800–2 000 nm**  
**HR (0°, 800–2 000 nm) > 97 %**  
**HRs (45°, 800–2 000 nm) > 98 %**  
**HRp (45°, 800–2 000 nm) > 97 %**  
**|GDD-Rs,p (0–45°, 800–2 000 nm)| < 5 fs<sup>2</sup>**



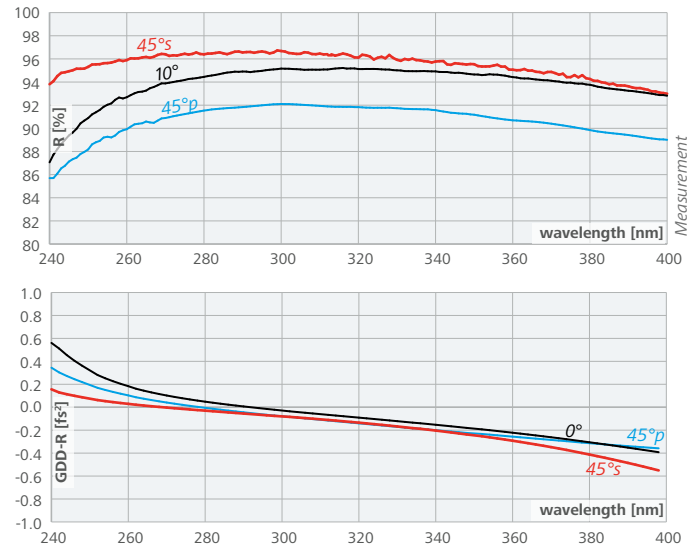
**LIDT**

6/ 5 J/cm<sup>2</sup>; 1 064 nm; 7 ns; 10 Hz; Ø480 µm      LAYERTEC  
 6/ 0.7 J/cm<sup>2</sup>; 795 nm; 42 fs; 1 kHz; Ø80 µm      WRCP Budapest

Substrate Dimensions	No.	Imperfections	Item #	Price
Ø 12.7 mm   t 6.35 mm	A4	5/ 2 x 0.025	142093	83 €
Ø 25.0 mm   t 6.35 mm	B4	5/ 2 x 0.04	142094	108 €
Ø 50.0 mm   t 9.5 mm	C3	5/ 6 x 0.04	142096	357 €
25 x 25 mm   t 6.35 mm	K2	5/ 2 x 0.04	142099	143 €

### Protected Aluminum Mirror, UV-range

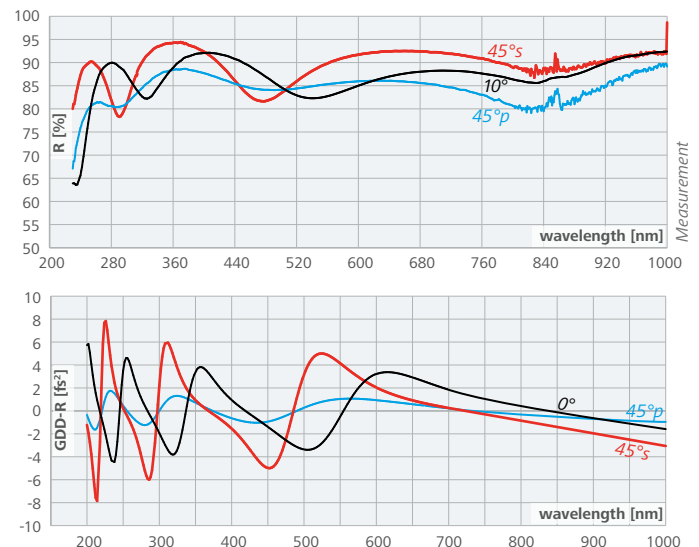
**Coating 142407**  
**Al enhanced, 260–360 nm opt.**  
**HRs,p (0–45°, 260–360 nm) ≥ 90 %**  
**|GDD-Rs,p (0–45°, 260–360 nm)| < 1 fs<sup>2</sup>**



Substrate Dimensions	No.	Imperfections	Item #	Price
Ø 12.7 mm   t 6.35 mm	A4	5/ 2 x 0.025	142415	88 €
Ø 25.0 mm   t 6.35 mm	B4	5/ 2 x 0.04	142416	126 €
Ø 50.0 mm   t 9.5 mm	C3	5/ 6 x 0.04	142417	465 €
25 x 25 mm   t 6.35 mm	K2	5/ 2 x 0.04	142418	170 €

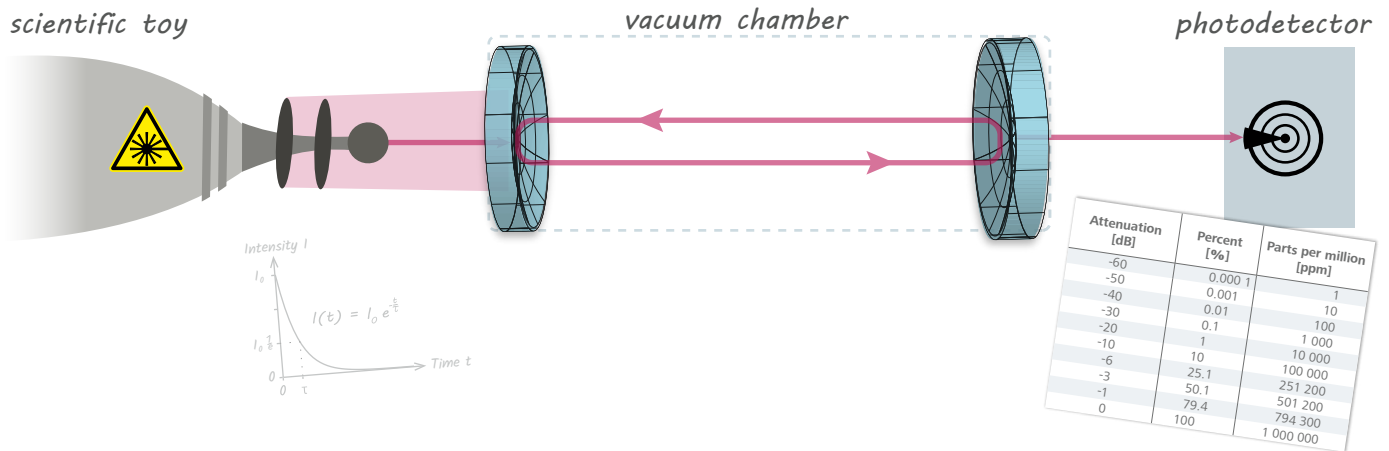
### Protected Aluminum Mirror, UV-VIS-range

**Coating 140842**  
**Al+protection layer**  
**HRs,p (0–45°, 266+400+800 nm) > 80 %**  
**|GDD-Rs,p (0–45°, 266+400+800 nm)| < 10 fs<sup>2</sup>**  
*for polarization-sensitive and low-power ultrafast applications*



Substrate Dimensions	No.	Imperfections	Item #	Price
Ø 12.7 mm   t 6.35 mm	A4	5/ 2 x 0.025	142069	54 €
Ø 25.0 mm   t 6.35 mm	B4	5/ 2 x 0.04	142071	90 €
Ø 50.0 mm   t 9.5 mm	C3	5/ 6 x 0.04	142091	330 €
25 x 25 mm   t 6.35 mm	K2	5/ 2 x 0.04	142092	120 €

# Low Loss Mirrors for CRD-Measurements



For optics not specified here, please visit [www.layertec.de](http://www.layertec.de), contact us at [info@layertec.de](mailto:info@layertec.de) or call us at +49 (0)36453 744 0.

## Principal Curves of Reflectance and Transmittance

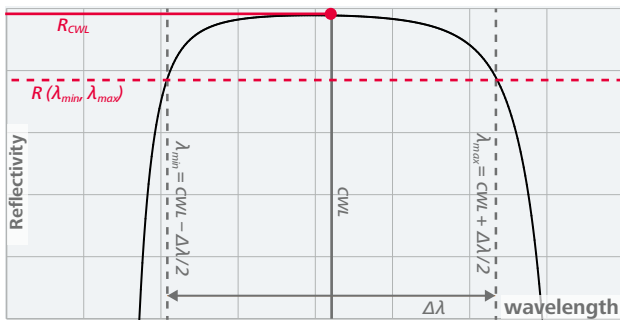


Figure 1: Principal curve of reflectivity of a low loss mirror and definition of central wavelength (CWL) and bandwidth ( $\Delta\lambda$ )

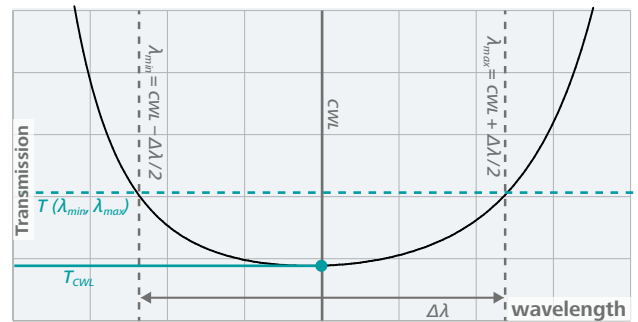


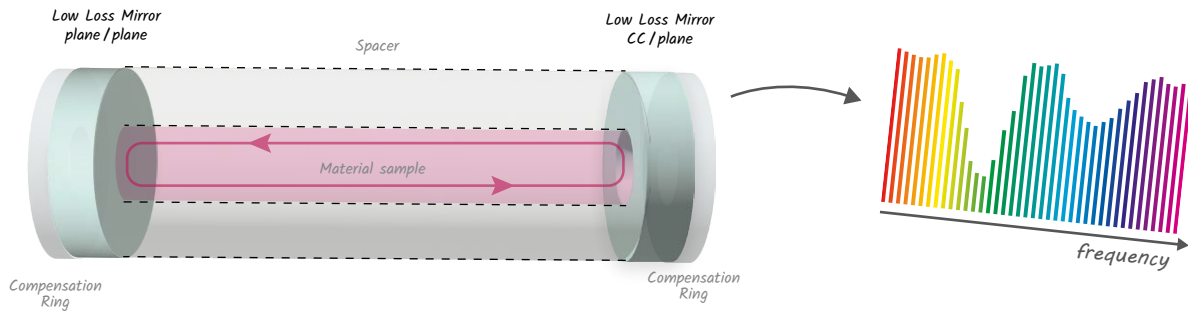
Figure 2: Principal curve of transmission of a low loss mirror and definition of central wavelength (CWL) and bandwidth ( $\Delta\lambda$ )

CWL	R <sub>CWL</sub> [%]	T <sub>CWL</sub> [ppm]	Δλ	R [%]	T [ppm]	Substrate Dimensions [mm]	No.	Imperfections	Item #	Price
350 (±7)nm	>99.95	30	35 nm	99.93	50	Ø 12.7   t 6.35   CC 1000	R13	Ø <sub>e</sub> 8 5/ 2 x 0.016	140970	234 €
						Ø 25.0   t 6.35   CC 1000	S13	Ø <sub>e</sub> 20 5/ 2 x 0.04   Ø <sub>e</sub> 10 5/ 2 x 0.016	140949	474 €
520 (±10)nm	>99.99	20	60 nm	99.98	100	Ø 12.7   t 6.35   CC 1000	R13	Ø <sub>e</sub> 8 5/ 2 x 0.016	140969	234 €
						Ø 25.0   t 6.35   CC 1000	S13	Ø <sub>e</sub> 20 5/ 2 x 0.04   Ø <sub>e</sub> 10 5/ 2 x 0.016	140964	474 €
640 (±15)nm	>99.99	20	80 nm	99.98	100	Ø 12.7   t 6.35   CC 1000	R13	Ø <sub>e</sub> 8 5/ 2 x 0.016	140968	234 €
						Ø 25.0   t 6.35   CC 1000	S13	Ø <sub>e</sub> 20 5/ 2 x 0.04   Ø <sub>e</sub> 10 5/ 2 x 0.016	140965	474 €
760 (±15)nm	>99.995	15	110 nm	99.99	100	Ø 12.7   t 6.35   CC 1000	R13	Ø <sub>e</sub> 8 5/ 2 x 0.016	140967	234 €
						Ø 25.0   t 6.35   CC 1000	S13	Ø <sub>e</sub> 20 5/ 2 x 0.04   Ø <sub>e</sub> 10 5/ 2 x 0.016	140966	474 €
960 (±20)nm	>99.995	20	110 nm	99.99	100	Ø 12.7   t 6.35   CC 1000	R13	Ø <sub>e</sub> 8 5/ 2 x 0.016	140992	234 €
						Ø 25.0   t 6.35   CC 1000	S13	Ø <sub>e</sub> 20 5/ 2 x 0.04   Ø <sub>e</sub> 10 5/ 2 x 0.016	140974	474 €
1045 (±20)nm	>99.995	20	120 nm	99.99	100	Ø 12.7   t 6.35   CC 1000	R13	Ø <sub>e</sub> 8 5/ 2 x 0.016	140973	234 €
						Ø 25.0   t 6.35   CC 1000	S13	Ø <sub>e</sub> 20 5/ 2 x 0.04   Ø <sub>e</sub> 10 5/ 2 x 0.016	140971	474 €
1260 (±20)nm	>99.995	15	190 nm	99.99	100	Ø 12.7   t 6.35   CC 1000	R13	Ø <sub>e</sub> 8 5/ 2 x 0.016	140991	234 €
						Ø 25.0   t 6.35   CC 1000	S13	Ø <sub>e</sub> 20 5/ 2 x 0.04   Ø <sub>e</sub> 10 5/ 2 x 0.016	140975	474 €
1392 (±20)nm	>99.995	15	200 nm	99.99	100	Ø 12.7   t 6.35   CC 1000	R13	Ø <sub>e</sub> 8 5/ 2 x 0.016	140989	234 €
						Ø 25.0   t 6.35   CC 1000	S13	Ø <sub>e</sub> 20 5/ 2 x 0.04   Ø <sub>e</sub> 10 5/ 2 x 0.016	140976	474 €
1550 (±20)nm	>99.99	50	130 nm	99.99	100	Ø 12.7   t 6.35   CC 1000	R13	Ø <sub>e</sub> 8 5/ 2 x 0.016	140987	234 €
						Ø 25.0   t 6.35   CC 1000	S13	Ø <sub>e</sub> 20 5/ 2 x 0.04   Ø <sub>e</sub> 10 5/ 2 x 0.016	140977	474 €
1670 (±20)nm	>99.99	25	180 nm	99.99	100	Ø 12.7   t 6.35   CC 1000	R13	Ø <sub>e</sub> 8 5/ 2 x 0.016	140986	234 €
						Ø 25.0   t 6.35   CC 1000	S13	Ø <sub>e</sub> 20 5/ 2 x 0.04   Ø <sub>e</sub> 10 5/ 2 x 0.016	140980	474 €
1980 (±20)nm	>99.99	25	180 nm	99.99	100	Ø 12.7   t 6.35   CC 1000	R13	Ø <sub>e</sub> 8 5/ 2 x 0.016	140984	234 €
						Ø 25.0   t 6.35   CC 1000	S13	Ø <sub>e</sub> 20 5/ 2 x 0.04   Ø <sub>e</sub> 10 5/ 2 x 0.016	140981	474 €
2300 (±30)nm	>99.99	25	220 nm	99.99	100	Ø 12.7   t 6.35   CC 1000	R13	Ø <sub>e</sub> 8 5/ 2 x 0.016	140983	234 €
						Ø 25.0   t 6.35   CC 1000	S13	Ø <sub>e</sub> 20 5/ 2 x 0.04   Ø <sub>e</sub> 10 5/ 2 x 0.016	140982	474 €

Low Loss Mirrors are shipped with individual CRD measurement reports (reflectance and transmittance). CRD measurement reports can also be requested individually for all Low Loss Mirrors in stock.

# Low Loss Mirror Set for High Finesse Cavities

Please contact us regarding your coating specifications.



## Plane / Plane Substrate

Customized Coating on ULE or Fused Silica

Dimensions:  $\varnothing$  25.0mm, t 6.35mm

(No. B4 g/h)

S2: plane,  $\lambda/10$ ,

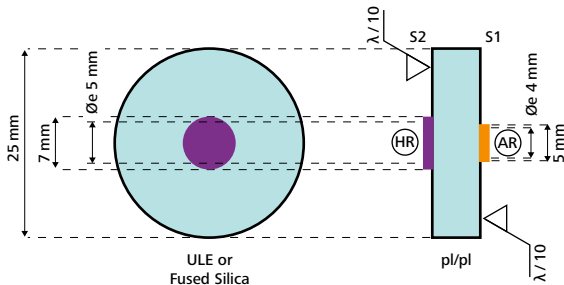
HR-coating  $\varnothing$  7 mm (with  $\varnothing_e$  5 mm)

edge area: polished for optical contacting to spacers

S1: plane,  $\lambda/10$ ,

AR-coating  $\varnothing$  5 mm (with  $\varnothing_e$  4 mm)

edge area: polished for optical contacting to compensation ring



Principal sketch

## CC 1 000 / Plane Substrate

Customized Coating on ULE or Fused Silica

Dimensions:  $\varnothing$  25.0mm, t 6.35 mm, CC 1 000 mm

(No. T1 a/b)

S2: CC 1 000 mm,  $\lambda/10$ ,

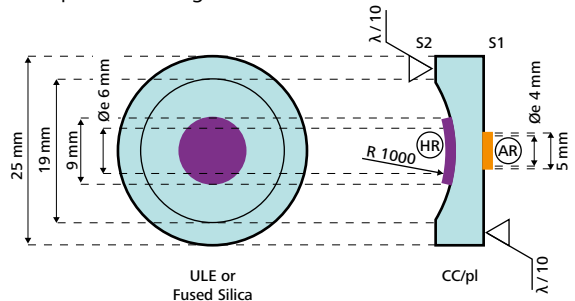
HR-coating  $\varnothing$  9 mm (with  $\varnothing_e$  6 mm)

edge area: polished for optical contacting to spacers

S1: plane,  $\lambda/10$ ,

AR-coating  $\varnothing$  5 mm (with  $\varnothing_e$  4 mm)

edge area: polished for optical contacting to compensation ring



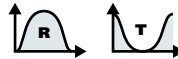
Principal sketch



## Bundle



1 coating batch up to 8 substrates (free choice)  
Typical yield and cleanliness: see tables page 35



Spectral CRD measurement of reflectance & transmittance in vacuum with ppm accuracy



Customized coatings for HR- and AR side



Measurement report and clean-room packaging (single item packaging)



Laser engraving

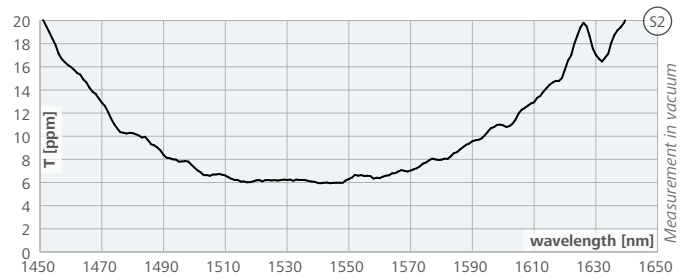
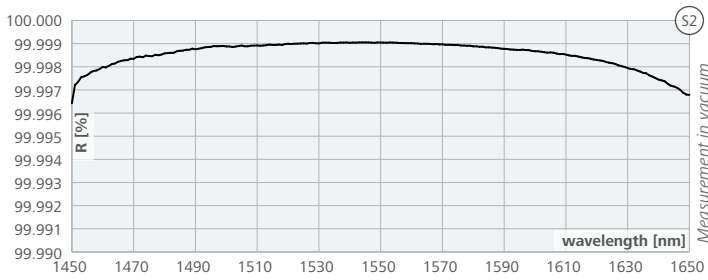
**Bundle price**

**5 000 – 7 000 €**

Please contact us regarding your coating specifications (wavelength, finesse range, required transmittance). Depending on wavelengths and coating complexity, the achievable reflectance may differ. Therefore, it is validated before shipping by in-house CRD measurements.

### Example Coating 1

**Low Loss Mirror for 1 Wavelength**  
**HR (0°, 1 542 nm) > 99.998 %**  
**T (0°, 1 542 nm) ~5–7 ppm**



Substrate Dimensions	No.	Batch	Price
Ø 25.0   t 6.35	B4g/h	1*	5 800 €
Ø 25.0   t 6.35   CC 1000	T1 a/b		

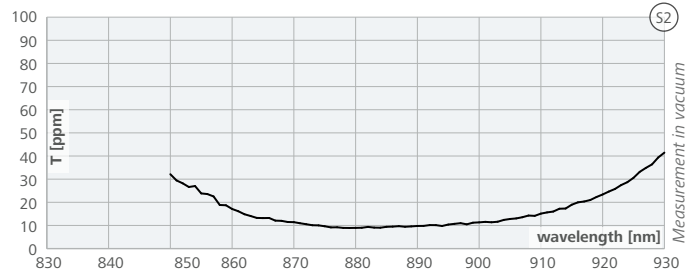
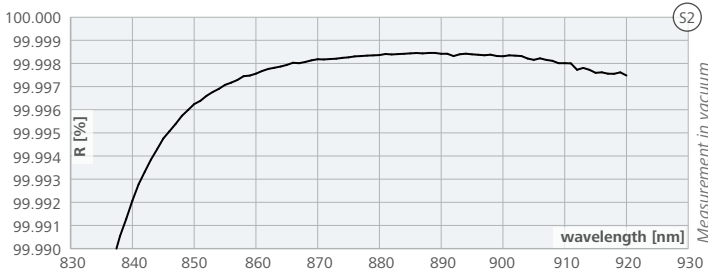
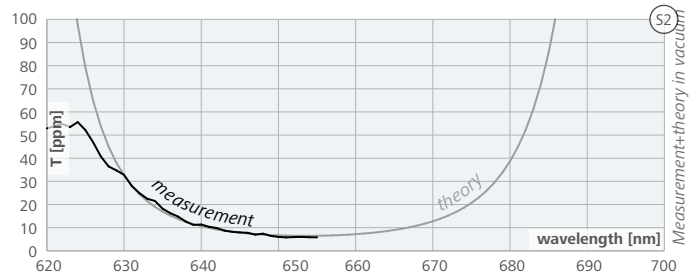
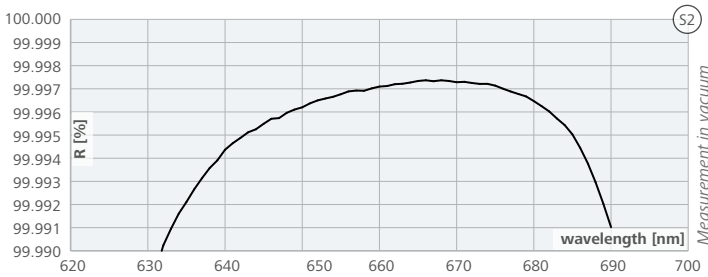
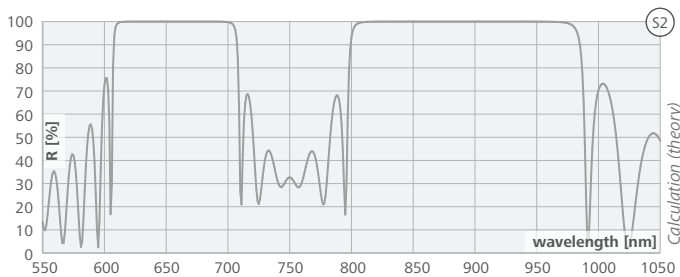
\*1 batch up to 8 pieces

Pieces	Imperfections
4	5 / 1 x 0.006
2	5 / 1 x 0.01
2	5 / 1 x 0.025

Defect distribution within 1 batch (up to 8 pieces)

### Example Coating 2

**Low Loss Mirror for 3 Wavelengths**  
**HR (0°, 647 nm) > 99.996 % | HR (0°, 871+920 nm) > 99.99 %**  
**T (0°, 647 nm) ~5–10 ppm | T (0°, 871 nm) ~5–15 ppm | T (0°, 920 nm) ~20–30 ppm**



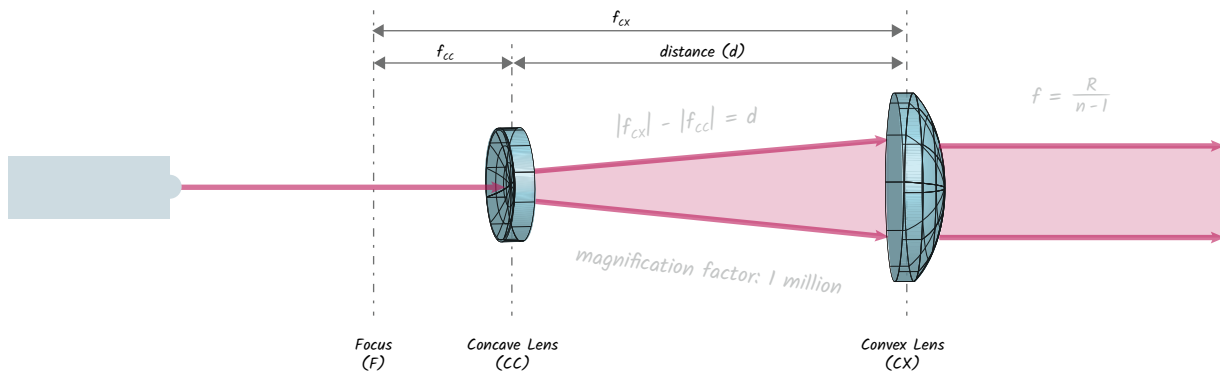
Substrate Dimensions	No.	Batch	Price
Ø 25.0   t 6.35	B4g/h	1*	6 500 €
Ø 25.0   t 6.35   CC 1000	T1 a/b		

\*1 batch up to 8 pieces

Pieces	Imperfections
4	5 / 1 x 0.006
2	5 / 1 x 0.01
2	5 / 1 x 0.025

Defect distribution within 1 batch (up to 8 pieces)

# Beam Expanders



## Lens Matrix

### Magnification / reduction factor with distance d

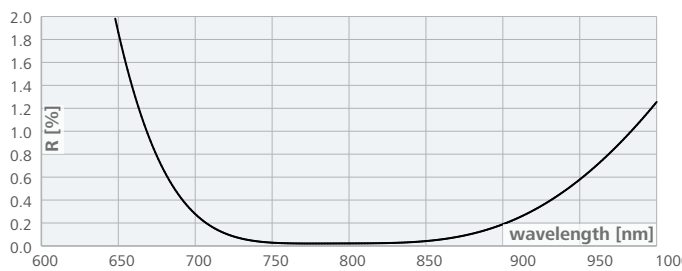
☒ ROC of CC Lens	☐ ROC of CX Lens			
	CX 125	CX 150	CX 175	CX 200
CC 100	1.25 (d ≈ 55 mm)	1.5 (d ≈ 110 mm)	1.75 (d ≈ 165 mm)	2 (d ≈ 220 mm)
CC 75	1 2/3 (d ≈ 110 mm)	2 (d ≈ 165 mm)	2 1/3 (d ≈ 220 mm)	2 2/3 (d ≈ 275 mm)
CC 50	2.5 (d ≈ 165 mm)	3 (d ≈ 220 mm)	3.5 (d ≈ 275 mm)	4 (d ≈ 330 mm)
CC 25	5 (d ≈ 220 mm)	6 (d ≈ 275 mm)	7 (d ≈ 330 mm)	8 (d ≈ 390 mm)

Magnification and reduction factor depending on the ratios of the radii of curvature of concave (CC) and convex (CX) lens, distance d is calculated for Fused Silica @920 nm (with n = 1.4515)

1. Select an magnification or reduction factor from the table on the left. For your convenience the lens distance is also given in the table.
2. Find the corresponding ROC (radius of curvature) for both lenses. The concave lens (CC) is indicated on the left, the convex lens (CX) on the top.
3. Select the two lenses for your preferred spectral range from the tables below.

## Lenses 0°, 800 nm

Coating 160878  
AR (0°, 725–875 nm) < 0.5 %

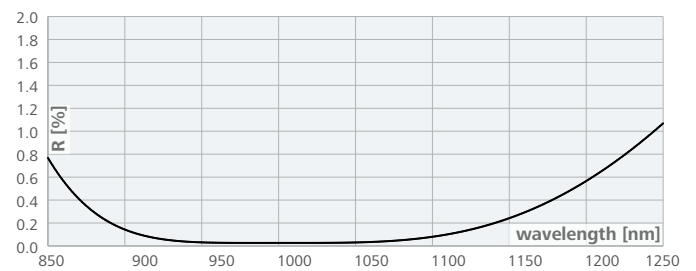


Calculated reflection for each side

Substrate Dimensions [mm]	No.	Imperfections	Item #	Price
Ø 25.0   t <sub>c</sub> 6.35   CC 25	L1a	Ø <sub>e</sub> 15   5/ 1x0.04	160716	438€
Ø 25.0   t <sub>c</sub> 6.35   CC 50	L1b	Ø <sub>e</sub> 15   5/ 1x0.04	160717	390€
Ø 25.0   t <sub>c</sub> 6.35   CC 75	L1c	Ø <sub>e</sub> 20   5/ 1x0.04	160718	360€
Ø 25.0   t <sub>c</sub> 6.35   CC 100	L1d	Ø <sub>e</sub> 20   5/ 1x0.04	160719	348€
Ø 50.0   t <sub>c</sub> 6.35   CX 125	L2a	Ø <sub>e</sub> 30   5/ 2x0.04	160720	864€
Ø 50.0   t <sub>c</sub> 6.35   CX 150	L2b	Ø <sub>e</sub> 30   5/ 2x0.04	160721	852€
Ø 50.0   t <sub>c</sub> 6.35   CX 175	L2c	Ø <sub>e</sub> 30   5/ 2x0.04	160722	840€
Ø 50.0   t <sub>c</sub> 6.35   CX 200	L2d	Ø <sub>e</sub> 30   5/ 2x0.04	160723	828€

## Lenses 0°, 1000 nm

Coating 160881  
AR (0°, 900–1100 nm) < 0.5 %



Calculated reflection for each side

Substrate Dimensions [mm]	No.	Imperfections	Item #	Price
Ø 25.0   t <sub>c</sub> 6.35   CC 25	L1a	Ø <sub>e</sub> 15   5/ 1x0.04	160704	438€
Ø 25.0   t <sub>c</sub> 6.35   CC 50	L1b	Ø <sub>e</sub> 15   5/ 1x0.04	160707	282€
Ø 25.0   t <sub>c</sub> 6.35   CC 75	L1c	Ø <sub>e</sub> 20   5/ 1x0.04	160710	360€
Ø 25.0   t <sub>c</sub> 6.35   CC 100	L1d	Ø <sub>e</sub> 20   5/ 1x0.04	160711	348€
Ø 50.0   t <sub>c</sub> 6.35   CX 125	L2a	Ø <sub>e</sub> 30   5/ 2x0.04	160712	864€
Ø 50.0   t <sub>c</sub> 6.35   CX 150	L2b	Ø <sub>e</sub> 30   5/ 2x0.04	160713	852€
Ø 50.0   t <sub>c</sub> 6.35   CX 175	L2c	Ø <sub>e</sub> 30   5/ 2x0.04	160714	840€
Ø 50.0   t <sub>c</sub> 6.35   CX 200	L2d	Ø <sub>e</sub> 30   5/ 2x0.04	160715	828€

Note: The AR coatings shown here are options. On request, LAYERTEC offers the anti-reflective quartz glass lens set for any wavelength in the range of 190–2200 nm (except 1370–1420 nm).

# Precision Optics

## Chapter Index

<b>How to Specify Substrates .....</b>	<b>134</b>
Material .....	134
Shape.....	134
Size .....	134
Tolerances .....	134
Surface Form Tolerances.....	135
Coating Stress .....	135
Defects.....	135
<b>Standard Quality Substrates .....</b>	<b>136</b>
Standard Specifications .....	136
<b>Substrate Materials .....</b>	<b>138</b>
Fused Silica.....	138
Calcium Fluoride.....	139
Sapphire.....	139
Yttrium Aluminum Garnet .....	140
Various Substrate Materials for UV, VIS and NIR/IR Optics.....	141
<b>Optical Fabrication Methods .....</b>	<b>142</b>
Manufacturing Technologies .....	142
Plane Optics .....	143
Spherical Optics.....	143
Cylinder Optics .....	144
Aspheres & Free Forms.....	145
Special Surfaces.....	148
Large Scale Optics .....	149
Scanning Mirrors & Lightweight Structures.....	150
Etalons & Waveplates.....	151
<b>Measurement Tools for Testing Substrates.....</b>	<b>152</b>
Surface Form Deviations.....	152
Surface Form Measurement.....	152
Surface Roughness Measurement.....	153
Measurement Systems for Testing Substrates.....	154

# How to Specify Substrates

Price and quality of substrates are determined by material, shape, size, tolerances and polishing quality.

## Material

The first decision is the choice of the substrate material. It should be free of absorption for all wavelengths of high transmittance. If no transmittance occurs, a low-cost material can be used, e.g. Borofloat® (SCHOTT AG), for metallic mirrors. With respect to the surface form tolerance, a low thermal expansion is beneficial.

## Shape

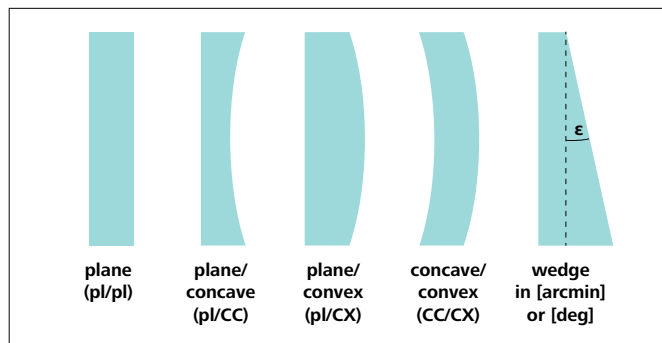


Figure 1: Conventions for the specifications of the shape of different types of substrates (schematic drawing)

The shape must be specified for both sides separately. All combinations of plane, convex and concave surfaces are possible. This is also the case for wedges, e.g. 30 arcmin, which can be applied to any kind of surface, plane as well as convex or concave. For curved substrates there are different conventions for the sign of the radius of curvature. Sometimes "+" means convex and "-" means concave. Other users refer to the direction of light propagation. In this case, "+" means "curvature in the direction of propagation" and "-" means "curvature against the direction of propagation". Please specify concave or convex in words or using the acronyms CC or CX to avoid confusion.

## Size

The main decision should be about the size of the substrate, i.e. edge length or diameter. Small diameters are more favorable for production. The sagitta heights become lower, so it is easier to achieve a good form tolerance. Although often denoted otherwise in optical designs, LAYERTEC specifies the thickness as the maximum thickness of the substrate, i.e. the center thickness for plano-convex substrates and the edge thickness for plano-concave substrates. Consequently, the thickness of a wedged plate is measured on the thicker side.

In order to achieve a good form tolerance, the ratio of diameter and thickness should be considered. As a rule of thumb the thickness should be at least one fifth of the diameter. Of course, other ratios are possible but production costs and therefore prices increase as well.

## Tolerances

Besides size and material, the tolerances are most important for manufacturing costs and thus pricing. Of course, the optics must fit into the mount, so the diameter should not be larger than specified. Thus, the most common specification is  $\varnothing = X \text{ mm } (+0 \text{ mm}/-0.1 \text{ mm})$ . In contrast, the thickness is generally free in both directions. LAYERTEC usually specifies it with a tolerance of  $\pm 0.1 \text{ mm}$ . There is a lot of confusion about the specification of wedge, parallelism and centering. Please note that wedge and parallelism describe the angle between the optical surfaces while centering describes the angle between the optical surfaces and the side surfaces. LAYERTEC standard substrates have a parallelism better than 5 arcmin. Specially made parallels may have a parallelism lower than 10 arcsec. Standard wedged substrates have wedges of  $0.5^\circ$  or  $1^\circ$ . Larger wedge angles are possible depending on the substrate size. In general, the  $90^\circ$  angle between optical and side surface has a precision of 20 arcmin. Centering is an additional optics processing step which improves this accuracy to a few arcmin.

Curved substrates can be described using the same nomenclature. It should be distinguished between mirrors and lenses. The side surfaces of mirror substrates are parallel. Nevertheless, the direction of the optical axis can be inclined with respect to the side surfaces. After centering, the side surfaces are parallel to the optical axis.



## Surface Form Tolerances

The surface form tolerance is usually measured by interferometers and is specified in terms of the reference wavelength ( $\lambda = 546 \text{ nm}$  if not otherwise stated). In order to avoid confusion, it is necessary to clearly distinguish between flatness, power and irregularity. In the following, flatness and irregularity shall be explained for a plane surface. Generally speaking, every real surface is more or less curved. Imagine that the "peaks" and "valleys" of a real surface are covered by parallel planes (see figure 2). The distance between these planes is called the flatness. This flatness consists of two contributions. The first contribution is a spherical bend of the surface, which may be described by a best fitted sphere to the surface. With respect to an ideal plane, the sagitta of this curvature is denoted as power. This spherical bend does not affect the quality of the reflected beam. It just causes a finite focal length. The second contribution is the deviation from the best fitted sphere, which is named irregularity. This is the most important value for the quality of the beam.

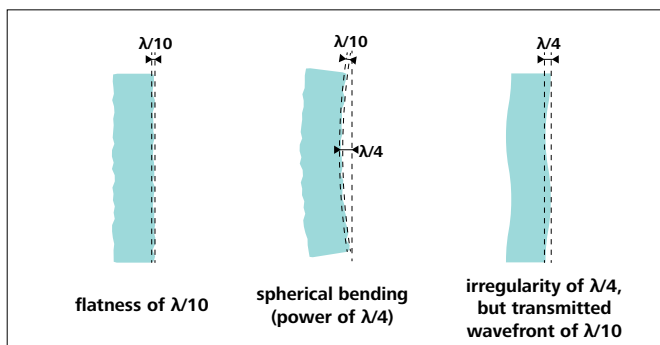


Figure 2: Schematic drawing for the explanation of substrate properties

Using the optics only for transmittance (e.g. laser windows), power as well as irregularity do not matter. A transmitted beam is not affected if the optics has the same thickness all over the free aperture. The influence of thickness deviations on the transmitted beam is defined in a similar way as the flatness. It is also measured in parts of the reference wavelength and called "transmitted wave front" (13/). For instance, the window in figure 2 has a flatness of  $\lambda/4$  but a transmitted wave front of  $\lambda/10$ .

## Coating Stress

Thin substrates cannot withstand the coating stress. The coating will cause a spherical deformation (for rotationally symmetric coatings). This means that a finite sagitta or power occurs. In case of circular substrates, the irregularity is not affected by this issue. Even if power deviation is considered, the quality of a beam under normal incidence is not affected.

## Defects

ISO 10110 is an international standard for the description of optical elements. According to ISO 10110, maximum permissible surface imperfections can be specified as item number 5/ in technical drawings. It allows for dimensional as well as visibility specification of surface imperfections, the latter being based on the MIL-O-13830 standard.

In the visibility specification, scratches and digs have to be distinguished. The scratch number refers to the visibility of the biggest scratch compared to the corresponding one on a norm template. "10" is the smallest scratch on this template. Thus, better qualities cannot be specified legitimately. Moreover, the visibility specification does not specify a directly measured but an apparent scratch width. The number is interpreted as tenths of a micron or as microns. In contrast, the dig number can be determined easily. The numerical value is equal to the maximum apparent dig diameter in hundredths of a millimeter. One maximum-size dig per 20 mm clear aperture is allowed.

In the numerical specification, the grade number is the side length in millimeters of a square area which is equivalent to the total defect area. So,  $1 \times 0.025$  describes a surface defect area of  $625 \mu\text{m}^2$ . Additionally, scratches of any length are denoted with a leading L. A long scratch, i.e. exceeding 2 mm of length, with a width of 4 microns would be specified as  $L 1 \times 0.004$ .

All these explanations are very simplified. For a detailed specification please read the complete text of the relevant standard.

## Please Note

There is no direct conversion between visibility and dimensional specification. All specifications in this catalog are dimensional. The mentioned scratch/dig values are rough approximations.

The standard ISO 10110 provides a sufficient method for specifying the surface form tolerance. Having the best comparability with the measurement results, all values are specified as numbers of interference fringes, with 1 fringe =  $\lambda/2$ . In technical drawings according to ISO 10110, the surface form tolerance is allocated as item number 3/: **3/ power (irregularity)**

Example: A slightly bent ( $\lambda/4$ ) optics which is regular ( $\lambda/10$ ) would be specified as follows:

**3/ 0.5 (0.2)**

## Standard Quality Substrates

The precision optics facility of LAYERTEC produces plane and spherically curved mirror substrates, lenses and prisms of Fused Silica, optical glasses like N-BK7<sup>®</sup> and some crystalline materials, e.g. calcium fluoride and YAG. In the following you can find information on the specifications of our standard substrates. Please do not hesitate to contact us also for other sizes, shapes, radii and materials or for special components. For cylindrical, aspherical and free form optics see page 144 and 145.

### Standard Specifications

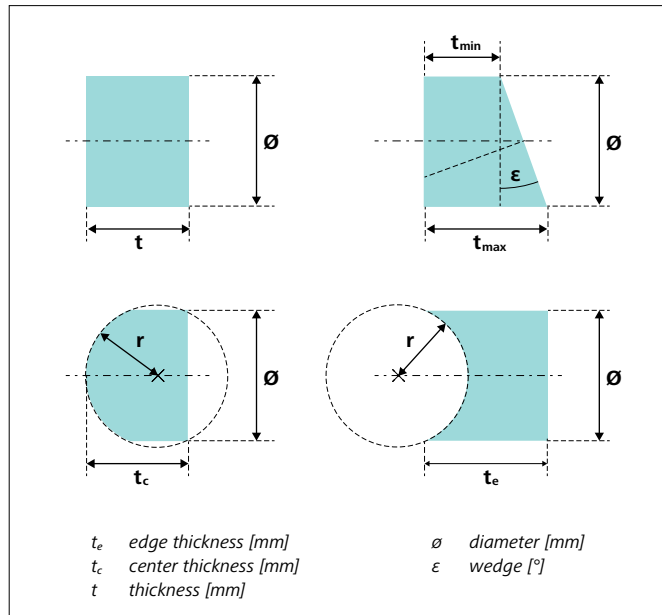


Figure 1: Standard specifications of optics

#### Materials

- Fused Silica: Corning 7980<sup>®</sup> or equivalent
- Fused Silica for high power applications in the NIR: Suprasil<sup>®</sup> 300/3001/3002 / Corning 7979<sup>®</sup> or equivalent
- UV Fused Silica (excimer grade): SQ1 E-193<sup>®</sup> and SQ1 E-248<sup>®</sup>
- IR Fused Silica: Infrasil 302<sup>®</sup> or equivalent
- ULE<sup>®</sup>
- Zerodur<sup>®</sup>
- N-BK7<sup>®</sup> or equivalent
- CaF<sub>2</sub>: single crystal, randomly oriented, special orientations on request, excimer grade (248 nm and 193 nm) on request
- Saphir: single crystal, C-cut
- YAG: undoped, single crystal, randomly oriented
- Further information on the substrate materials most frequently used can be found on page 138 ff.

#### Plane substrates, parallels and wedges

- Standard plane substrates: wedge < 5 arcmin
- Standard parallels: wedge < 1 arcmin or wedge < 10 arcsec
- Standard wedges: wedge = 30 arcmin or wedge = 1 deg

#### Plano-concave and plano-convex substrates

- Standard radii: 25, 30, 38, 50, 75, 100, 150, 200, 250, 300, 400, 500, 600, 750, 1000, 2000, 3000, 4000, 5000 mm
- Other radii on request

#### Dimensions

- Fused Silica, ULE<sup>®</sup>, Zerodur<sup>®</sup>: diameter 3 ... 600 mm
- Calcium fluoride, sapphire: diameter 3 ... 50.8 mm
- YAG: diameter 3 ... 38.1 mm
- Rectangular substrates and other diameters available on request

#### Tolerances

- Diameter: +0 mm, -0.1 mm
- Thickness: ±0.1 mm
- Clear aperture: central 85 % of dimension
- Chamfer: 0.2 ... 0.4 mm at 45°

**Table 1:** Surface form tolerances (reference wavelength: 546 nm)

Material	Shape	Standard Specification	On Request
Fused Silica	plane spherical	$\lambda/10$ $\lambda/10$ reg.	$\lambda/30$ $\lambda/30$ reg. ( $\varnothing < 51$ mm)
ULE® und Zerodur®	plane spherical	$\lambda/10$ $\lambda/10$ reg.	$\lambda/30$ $\lambda/30$ reg. ( $\varnothing < 51$ mm)
N-BK7®	plane spherical	$\lambda/10$ $\lambda/10$ reg.	$\lambda/30$ $\lambda/30$ reg. ( $\varnothing < 51$ mm)
CaF <sub>2</sub>	plane $\varnothing < 26$ mm plane $\varnothing < 51$ mm spherical	$\lambda/10$ $\lambda/4$ $\lambda/4$ reg.	$\lambda/20$ $\lambda/20$ $\lambda/20$ reg. ( $\varnothing < 51$ mm)
Saphir		$\lambda/10$	$\lambda/30$
YAG	plane spherical	$\lambda/10$ $\lambda/8$ reg. (typically $\lambda/10$ reg.)	$\lambda/30$ $\lambda/30$ reg. ( $\varnothing < 51$ mm)
Si	plane spherical	$\lambda/10$ $\lambda/8$ reg. (typically $\lambda/10$ reg.)	$\lambda/20$ $\lambda/20$ reg. ( $\varnothing < 51$ mm)

**Table 2:** Surface imperfection tolerances

Material	Standard Roughness*	Standard Specifications	On Request*	
Fused Silica	< 0.2 nm	5/ 1 × 0.025 L1 × 0.004 Scratch-Dig 10-3	< 0.15 nm	5/ 1 × 0.016 L × 0.0005 Scratch-Dig 5-1
ULE®	< 0.2 nm	5/ 3 × 0.025 L1 × 0.004 Scratch-Dig 10-5	< 0.2 nm	5/ 1 × 0.016 L1 × 0.0005 Scratch-Dig 5-1
Zerodur®	< 0.4 nm	5/ 2 × 0.040 L1 × 0.004 Scratch-Dig 10-5	< 0.3 nm	5/ 2 × 0.025 L1 × 0.0010 Scratch-Dig 10-3
N-BK7®	< 0.3 nm	5/ 1 × 0.040 L1 × 0.004 Scratch-Dig 10-5	< 0.2 nm	5/ 2 × 0.025 L1 × 0.0010 Scratch-Dig 10-3
CaF <sub>2</sub>	< 0.3 nm	5/ 1 × 0.04 L5 × 0.006 Scratch-Dig 20-5	< 0.2 nm	5/ 2 × 0.025 L5 × 0.004 Scratch-Dig 10-2
Saphir	< 0.3 nm	5/ 1 × 0.025 L10 × 0.004 Scratch-Dig 20-3	< 0.2 nm	5/ 1 × 0.016 L1 × 0.0010 Scratch-Dig 10-2
YAG	< 0.2 nm	5/ 1 × 0.025 L2 × 0.004 Scratch-Dig 20-3	< 0.2 nm	5/ 1 × 0.016 L1 × 0.0005 Scratch-Dig 5-1
Si	< 0.3 nm	5/ 3 × 0.025 L10 × 0.004 Scratch-Dig 10-5	< 0.2 nm	5/ 3 × 0.016 L3 × 0.0005 Scratch-Dig 5-1

*All specifications according to ISO 10110 ( $\varnothing 25$  mm). The mentioned Scratch-Dig values are approximately equivalent to MIL-O-13830 which was incorporated into ISO-10110.*

\* Valid for measurements with optical profilometer taking into account spatial structures in the 1 – 70  $\mu$ m.

Please note: Scratches wider than 1  $\mu$ m are guaranteed not to occur. Specifications according to ISO 10110 are not possible because scratch widths down to 0.3  $\mu$ m can not be measured as would be required.

# Substrate Materials

## Fused Silica

### General Information

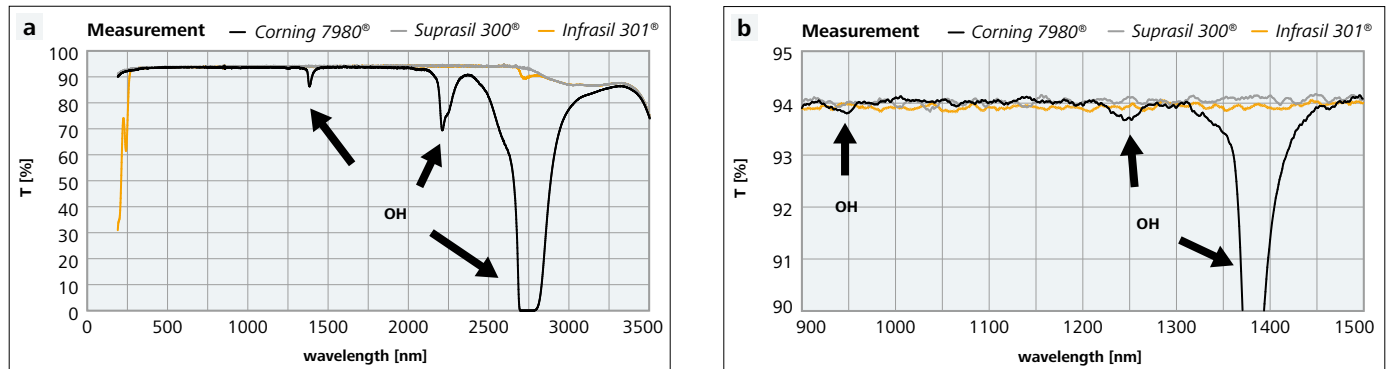


Figure 1: Transmittance spectrum of various types of Fused Silica, 6.35 mm thick (a) with close up of Fused Silica absorption band (b)

Fused Silica ( $\text{SiO}_2$ ) is one of the most important materials in the optical industry. For the production of high-performance optics, Fused Silica of particularly high quality is required. The purity of naturally occurring quartz is often insufficient for this purpose, so that synthetic quartz glass is used.  $\text{SiO}_2$  corresponds in its chemical composition to the simplest form of glass and is its most stable modification. Fused Silica has a refractive index of 1.46 (for  $\lambda = 500$  nm) and an Abbe number of 67.70. It transmits light from 180 nm to about 3  $\mu\text{m}$ . Absorption bands also occur within this transmission range due to the hydroxyl groups it contains. Fused Silica with high OH content has to be used for UV application whereas “low-OH” Fused Silica should be used for transmissive components in the 940 nm, 1390 nm and 2  $\mu\text{m}$  – 3  $\mu\text{m}$  wavelength range.

### Production

For the production of an amorphous (bubble- and streak-free) Fused Silica without impurities, there are different approaches that influence the final product in terms of optical specifications (see table).

Table 1: Optical specifications of Fused Silica depending on production technology

Separation/Source material	OH	Cl	Cations	UV- Edge 50 % transmission	Examples for trade marks
Electrofusion of quartz sand or rock crystal	< 20 ppm	0 ppm	50 – 300 ppm	220 nm	Infrasil <sup>®</sup> Vitresil-IR <sup>®</sup>
Flame melt mostly from rock crystal	200 – 500 ppm	0 ppm	10 – 50 ppm	210 nm	Homosil <sup>®</sup> Optosil <sup>®</sup>
Flame hydrolysis of silane or with silicon tetrachloride	600 – 1200 ppm	50 – 100 ppm	< 1 ppm	170 nm	Corning 7980 <sup>®</sup> Suprasil 1 <sup>®</sup> J-Plasma SQ <sup>®</sup>
Silicon tetrachloride in hydrogen/oxygen flame	< 20 ppm	< 200 ppm	1 – 2 ppm	170 nm	Suprasil 3001 <sup>®</sup>

### Properties and Applications

The most important properties of Fused Silica, which are essential for LAYERTEC’s products:

- High chemical purity
- Durability
- Heat resistance
- Low coefficient of thermal expansion at high temperatures
- High softening temperature
- High transparency over a wide spectral range (UV-IR)
- High radiation resistance

In the short wavelength and visual range Fused Silica (with higher OH content, e.g. Corning 7980<sup>®</sup>) is used. Excimergrade materials are used for transmissive optics for UV high power lasers. Standard Fused Silica is of limited use for transmissive optics in the infrared range. Naturally occurring Fused Silica (e.g. Infrasil<sup>®</sup>) and specially manufactured Fused Silica (e.g. SUPRASIL 3001/3002/300<sup>®</sup>, ...) have an extremely low OH content (< 20 ppm) and can therefore also be used for the infrared wavelength range to approximately 3  $\mu\text{m}$ .

## Calcium Fluoride

### General Information

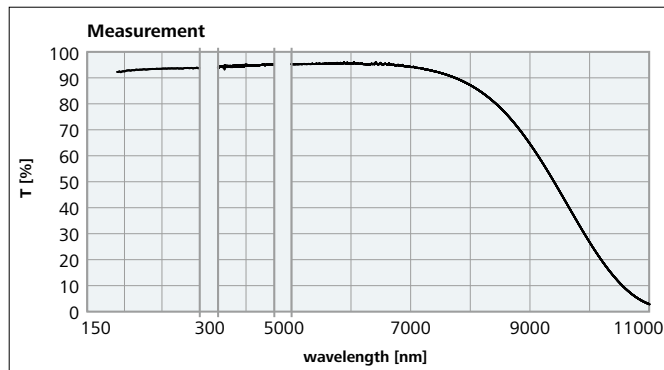


Figure 2: Transmittance spectrum calcium fluoride (3 mm thick)

Calcium fluoride ( $\text{CaF}_2$ ) is an optically homogeneous crystal material with a cubic structure. It is also called fluorspar and occurs naturally, but does not reach the purity required for UV applications in lithography or medicine. Crystal growth of  $\text{CaF}_2$  from synthetically produced raw materials can eliminate the inclusion of impurities. In addition, the refractive index of 1.43 (for  $\lambda = 500$  nm) can always be precisely adjusted and the homogeneity achieved exceeds that of glass. The Abbe number is 94.996 in all crystal directions. Calcium fluoride has a wide transmission range from 0.125  $\mu\text{m}$  to 8  $\mu\text{m}$ . The optical properties enable better correction of chromatic aberration than glass materials in the spectral range from VIS to NIR.

### Production

Fluorspar is extracted by open pit and deep mining. Due to the impurities it contains, it must first be processed. In this process, the starting material is crushed and purified by a multi-stage floatation process. Pure calcium fluoride is obtained by the reaction of hydrogen fluoride or hexafluorosilicic acid with calcium carbonate.

### Properties and Applications

The mechanical properties of  $\text{CaF}_2$  make machining optics a challenge. The material is very soft (Mohs hardness 4) and is therefore scratched easily. It can be easily cleaved (cleavage level 5 in plane). Due to its high coefficient of thermal expansion, there is a risk of cracking if machined quickly or if the temperature changes unevenly. In addition, it cannot be cemented to other materials. Uncoated polished surfaces react with atmospheric moisture and become hazy after prolonged exposure as micro-roughness increases. This creates stray light and reduces contrast.

Because of the high coefficient of thermal expansion, fluoride substrates should also be coated with fluoride layers if possible. Furthermore, heating and cooling rates must be observed to prevent cracking of the substrates.

Calcium fluoride is used at LAYERTEC for special applications in the ultraviolet range. It is processed into laser mirrors, output couplers, beam splitters, lenses, windows for excimer lasers and frequency-multiplied solid-state lasers, among others. In fluorine environment, the lifetime of  $\text{CaF}_2$  optics is significantly longer than that of other materials.

Due to the mechanical properties, it should be ensured in the application that the products are not subject to temperature fluctuations and temperature gradients. The optics should be stored with desiccant and under constant conditions. Therefore, the packaging should be opened only shortly before use.

## Sapphire

### General Information

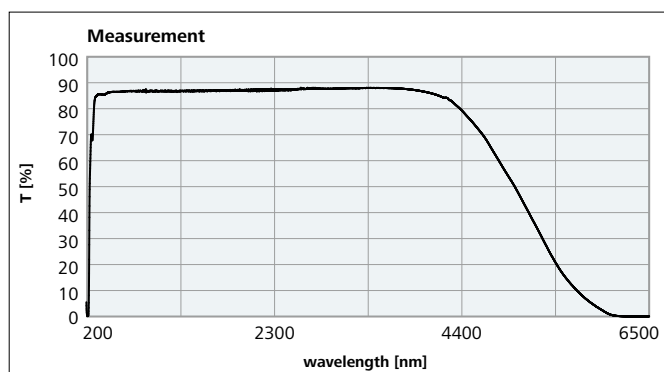


Figure 3: Transmittance spectrum of sapphire (3 mm thick)

The sapphire ( $\text{Al}_2\text{O}_3$ ) is a variation of the mineral corundum. For the optical industry, the synthesized form is used. Sapphire is an anisotropic material with a rhombic-hexagonal structure and shows different optical properties depending on the crystal axis and angle of incidence. These must be taken into account for the calculation of the final products. Sapphire is transparent in the range from 180 nm to about 4  $\mu\text{m}$ . The refractive index of the material is 1.77 – 1.78 (for  $\lambda = 500$  nm).

## Production

For the production of very high quality sapphires the Heat Exchanger Method (HEM) is used. This enables the production of large crystals. A heat exchanger takes care of the heat dissipation. In the process, the crystal growth region forms a temperature gradient. By controlling the gas volume in the heat exchanger and changing the heating power, this gradient is maintained. The crystal can now grow slowly from the bottom to the top.

The Verneuil method is applied to produce sapphire boules. These are also called stalagmites. Flame fusion is used in this process. Pure aluminum oxide is melted at nearly 2000°C. Due to gravity, liquid  $\text{Al}_2\text{O}_3$  falls onto a seedling and gradually forms a boule. The growth of a sapphire sphere sometimes takes several days.

## Properties and Applications

The most important properties of sapphire for use as a substrate material:

- Extreme hardness (Mohs hardness 9), can only be further processed with a few materials (e.g. diamond)
- Scratch resistance
- High chemical resistance
- Very good thermal conductivity
- Wide transmission range

Due to its optimum thermal conductivity and particularly good transmission properties in the mid-infrared range, sapphire is used at LAYERTEC primarily for high-performance components in the spectral range of 2 – 3  $\mu\text{m}$ .

## Yttrium Aluminum Garnet

### General Information

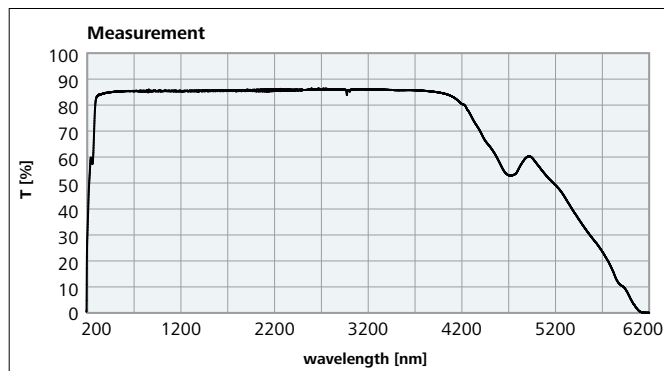


Figure 4: Transmittance spectrum of YAG undoped (3 mm thick)

Yttrium aluminum garnet ( $\text{Y}_3\text{Al}_5\text{O}_{12}$  or YAG) is a crystal material with cubic structure, which is produced synthetically. The refractive index is 1.84 (for  $\lambda = 500 \text{ nm}$ ). It indicates good transmission behavior in the range from 0.25  $\mu\text{m}$  to 4  $\mu\text{m}$ . Undoped YAG is free of absorption in the range of 2 – 3  $\mu\text{m}$ , whereas Fused Silica shows high absorption bands exactly here due to the higher proportion of OH groups.

## Production

The YAG crystal is produced mainly by the Czochralsky method. In this process, the already purified starting material is heated to a few degrees above the melting point without spontaneous nucleation. If a small single crystal is now immersed and moved upwards by slowly rotating and pulling it without breaking contact with the melt, single crystals of more than 300 mm in length and up to 100 mm in diameter are produced.

## Properties and Applications

YAG has several properties which are advantageous for the manufacturing of high performance optics. Its chemical and mechanical resistance are similar to sapphire. However, due to its lower Mohs hardness of 8.5, YAG is easier to machine. The crystal's high thermal conductivity and low absorption losses allow it to withstand high laser energies. The YAG crystal in doped form is also well suited for use as an active medium for lasers (Yb:YAG 1030 nm, Nd:YAG 1064 nm, Tm:YAG 2.01  $\mu\text{m}$ , Ho:YAG 2.1  $\mu\text{m}$ , Er:YAG 2.94  $\mu\text{m}$ ).

At LAYERTEC undoped YAG is used especially in the mid-infrared range (MIR) up to  $\approx 4 \mu\text{m}$ . It has the advantage over sapphire that it lacks birefringence and therefore no attention has to be paid to crystal cut and angle of incidence. In the in-house optics production YAG substrates are manufactured in different sizes both as flat parts and as curved substrates or lenses.

Various Substrate Materials for UV, VIS and NIR/IR Optics

Table 2: Specifications of various substrate materials

	Fused Silica (UV)	Infrasil <sup>®1)</sup>	YAG (undoped)	Sapphire (C-cut)	CaF <sub>2</sub>	N-BK7 <sup>®2)</sup>	Si
Wavelength range free of absorption	190 nm – 2.0 μm <sup>3)</sup>	300 nm – 3 μm	400 nm – 4 μm	400 nm – 4 μm	130 nm – 7 μm	400 nm – 1.8 μm	1.4 – 6 μm
Refractive Index at							
200 nm	1.55051				1.49516		
300 nm	1.48779				1.45403		
500 nm	1.46243	1.48799	1.8450	1.775	1.43648	1.5214	
1 μm	1.45051	1.45042	1.8197	1.756	1.42888	1.5075	
3 μm		1.41941	1.7855	1.71	1.41785		3.4381
5 μm				1.624	1.39896		3.4273
9 μm					1.32677		
Absorbing in the 3 μm region	yes	yes	no	no	no	yes	no
Absorbing in the 940 nm region	For high power applications at 940 nm the Fused Silica types SUPRASIL 300 <sup>®1)</sup> and SUPRASIL 3001/3002 <sup>®1)</sup> are recommended.						
Birefringence	no	no	no	yes	no <sup>4)</sup>	no	no
Thermal expansion coefficient [10 <sup>-6</sup> K <sup>-1</sup> ] <sup>5)</sup> (0 – 20°C)	0.5	0.5	7	5	18	7	2.6
Resistance against temperature gradients and thermal shock	high	high	high	high	low	medium	low
GDD fs <sup>2</sup> per mm							
400 nm	98	98	240	150	68	120	
800 nm	36	36	97	58	28	45	
1064 nm	16	16	61	29	17	22	
1500 nm	-22	-22	13	-25	1.9	-19	
2000 nm	-100	-100	-59	-120	-21	-99	
TOD fs <sup>3</sup> per mm							
400 nm	30	30	75	47	19	41	
800 nm	27	27	57	42	16	32	
1064 nm	44	44	71	65	21	49	
1500 nm	130	130	140	180	46	140	
2000 nm	450	450	360	530	120	460	

1) Registered trademark of Heraeus Quarzglas GmbH & Co. KG

2) Registered trademark of SCHOTT AG

3) Absorption band within this wavelength range, please see transmittance curve

4) Measurable effects only in the VUV wavelength range

5) Please note that different authors in the literature are inconsistent. Moreover, the thermal expansion coefficient of crystals may depend also on crystal orientation. Thus, the value given here are approximated.

All values are for informational purposes only. LAYERTEC cannot guarantee the correctness of the values given.

# Optical Fabrication Methods

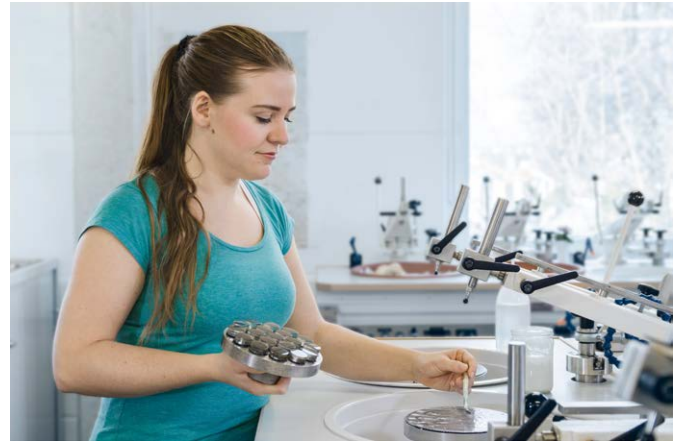
## Manufacturing Technologies

LAYERTEC has its own in-house precision optics facility where substrates with almost all geometries are manufactured. The optics are finished in our coating department according to individual customer requirements.

### Traditional and Alternative Fabrication Methods



*Figure 1: Conventional polishing of plane surfaces*



*Figure 2: Conventional polishing of spherical optics*

For the shaping of LAYERTEC optics, the production technologies grinding, lapping and polishing are mainly applied. Grinding is machining with geometrically undefined cutting edge. The cutting edges are irregularly arranged. The tool movement is rotary. The grain is bound in the tool. Lapping and polishing also belong to the machining processes with a geometrically undefined cutting edge. However, these are referred to as material removal by loose grains. The material is removed by a rolling movement of the lapping or polishing grains over the workpiece surface. From grinding to lapping to polishing, the grain sizes of the tools decrease. Each grain leaves surface imperfections in the order of the grain diameter during machining. The material removal of the next finer tool must be at least large enough to eliminate the surface defects of the previous one.

Besides the polishing of standard materials, LAYERTEC supports the polishing of various types of crystals such as YAG, KTP, LBO or BBO. This polishing technology also enables the careful handling and processing of small crystal sizes or extraordinary forms.

### Ultrasonic Cleaning



*Figure 3: Ultrasonic cleaning*

Ultrasonic cleaning represents the link between optics processing and coating in the production process. All substrates manufactured, purchased by LAYERTEC or provided by the customer must be absolutely clean before coating. Machining residues from optics production must be removed and the coating requirements for clean substrates must be met. LAYERTEC currently has 6 different ultrasonic cleaning systems for different requirements (e.g. crystal cleaning, pre-cleaning, fine cleaning, geometry dependent). The type of contamination determines the arrangement of the cleaning baths. Due to many years of experience in the field of ultrasonic cleaning, LAYERTEC has a broad knowledge base.

Material properties of individual cleaners, temperatures as well as drying processes are always taken into account. Tailor-made solvents and the appropriate arrangement of cleaning baths can be used to deal specifically with a wide range of contaminants (emulsions, polishing agents, particles, fingerprints, salts, oils, greases, wax, water, paints, polymers, inks, etc.).

### Ultrasonic Drilling

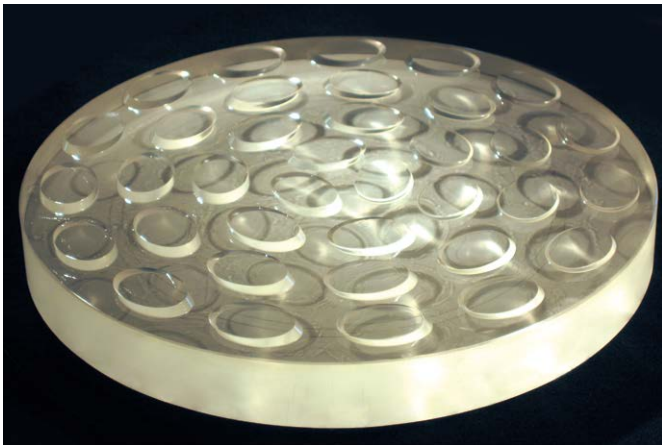


*Figure 4: Substrate with conical hole, produced by ultrasonic drilling*

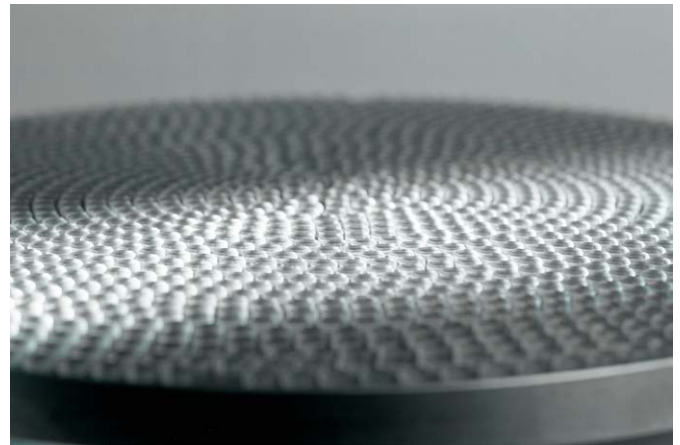
Using ultrasonic drilling, LAYERTEC is able to manufacture holes and other structures in a variety of forms and sizes in glass, ceramics or crystals in a low-tension way. Coated as well as uncoated optics may be processed.



## Plane Optics



**Figure 5:** Substrates for 45°-mirrors on multiple block



**Figure 6:** Lapped plane substrates on multiple block

Plane optics can be manufactured efficiently by using proven techniques of surface grinding, lapping and polishing.

Planar substrates are manufactured with diameters from 1.5 mm to 600 mm (round) or with edge lengths from 1 mm to 1200 mm (rectangular). Substrates down to a minimum thickness of 0.08 mm and any wedge can be produced. Special external geometries according to customer requirements are also possible.

Surface roughness of < 0.2 nm (usually measured for spatial structures in the range of 1  $\mu\text{m}$  – 70  $\mu\text{m}$ ) is possible. Depending on the application wavelength, both defined and optimized surface roughnesses can be manufactured.

Plane optics are made from the following materials:

- Fused Silica
- Crystalline Quartz
- YAG/LuAG
- $\text{CaF}_2$
- ULE<sup>®</sup>
- Zerodur<sup>®</sup>
- Silicon
- BBO/LBO/KTP
- All commercially available optical glasses
- Toxic substrate materials, like ZnSe are not processed

## Spherical Optics



**Figure 7:** Grinding process on CNC machine



**Figure 8:** Spherical optics on multiple block

At LAYERTEC, single and double-sided curved substrates with convex or concave shapes are manufactured. The processing of a variety of optical glasses (e.g. Fused Silica, N-BK7<sup>®</sup>, ULE<sup>®</sup>) and crystals (e.g. Si, YAG,  $\text{CaF}_2$ ) is possible. Available radii of curvature vary from 5 mm to 100 000 mm. Manufacturing of substrate diameters from  $\varnothing = 3$  mm to  $\varnothing = 600$  mm (see also Large Optics on 148) is possible.

For Fused Silica, the following specifications can be achieved:

- Surface form deviations:
  - Clear aperture up to 85 % of substrate diameter
  - Further test areas on request
  - 3/ -(0.2) ( $\lambda/10$ )
  - 3/ -(0.1) ( $\lambda/20$ ) on request
- Roughness  $S_q = 0.25$  nm (for measurements with an optical profilometer taking into account spatial structures in the 1 – 70  $\mu\text{m}$  range)
- Roughness  $S_q < 0.2$  nm on request

Depending on the geometry, a centering accuracy of 1 arcmin and a radius tolerance of  $\pm 0.5$  % can be achieved. We handle projects with special requirements on request.

## Cylinder Optics



**Figure 9:** Polishing machine for cylinder optics



**Figure 10:** Large cylindrical lens

At LAYERTEC, cylindrical lenses can be manufactured in both concave and convex shapes, with a radius of curvature on one or both sides. Round or angular component shapes are possible. Cylindrical lenses can be made of different materials (Fused Silica, N-BK7<sup>®</sup>, SF6, CaF<sub>2</sub>).

Cylindrical lenses with very small concave and convex radii in the order of  $r \geq 7$  mm can be manufactured. The production of radii up to  $r = 1900$  mm is possible with fit irregularities of  $\lambda/20$ .

With suitable metrology (e.g. white light interferometry, cylinder interferometry) the surface specifications for shape and polishing quality can be ensured.

**Table 1:** Specifications of cylinder optics of Fused Silica an CaF<sub>2</sub>

	Fused Silica	CaF <sub>2</sub>
Clear aperture	80 %	80 %
Surface form tolerance (irregularity)	standard $\lambda/4$ on request $\lambda/20$	standard $\lambda/4$ on request $\lambda/10$
Surface imperfection tolerance	25 mm × 25 mm standard $5/1 \times 0.04$ on request $5/1 \times 0.025$	12.7 mm × 12.7 mm standard $5/1 \times 0.063$ on request $5/1 \times 0.04$
Specifications for other sizes on request		

LAYERTEC's cylinder optics are used in aerospace, display manufacturing or laser generation, among others.

## Aspheres & Free Forms

Plane and spherical optics can be efficiently manufactured by using traditional techniques of area grinding and polishing. The tool always works on a significant fraction of the substrate area at once. However, it is hardly possible to manufacture surface geometries that differ from regular forms like planes, spheres or cylinders. Using ultra precision CNC machinery, surfaces can be processed zonally, i.e. the tool works on one point at a time. The possible surface forms and tolerances are only limited by the precision of the machine and the measurement equipment. In contrast to the areal techniques, zonal processing usually works with a single piece per run only. Non-spherical optics can be divided into three categories: rotationally symmetric, off-axis and free form optics.

### Rotationally Symmetric Non-Spherical Optics (Aspheres)

Although the term “asphere” may stand for any non-spherical optics, it is often restricted to rotationally symmetric optics. They are described by the following equation (cf. ISO 10110):

$$z(r) = \frac{r^2}{R \left[ 1 + \sqrt{1 - (1 + K) \frac{r^2}{R^2}} \right]} + A_3 r^3 + A_4 r^4 + \dots$$

$z$  = sagitta

$K$  = conic constant

$r$  = distance from axis,  $r = \sqrt{x^2 + y^2}$

$R$  = radius of curvature

$A_i$  = aspheric coefficients

Neglecting the aspheric coefficients leads to a profile of conic sections:

- Sphere:  $k = 0$
- Ellipse:  $-1 < k < \infty$
- Parabola:  $k = -1$
- Hyperbola:  $k < -1$

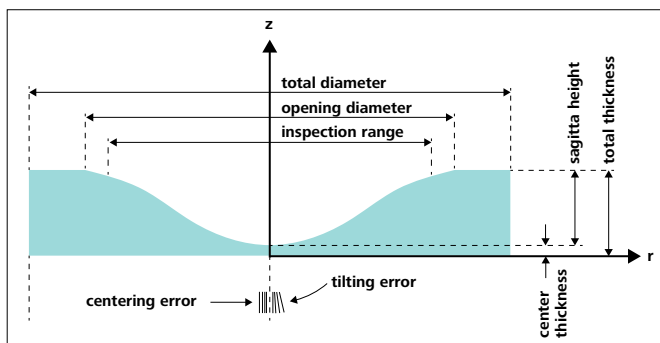


Figure 11: Profile of an aspheric mirror

Table 2: Production dimensions and tolerances

	Dimension	Tolerances
Total Diameter	25 – 560 mm	< 0.1 mm
Inspection Range	< 550 mm	
Total Thickness	< 100 mm	< 0.1 mm
Sagitta	< 50 mm	
Centering Error		< 50 μm
Tilt Error		< 30''
Surface form tolerance (P-V)		λ/4 (λ/10 on request)
Roughness*		< 0.3 nm

\* Valid for measurements with optical profilometer taking into account spatial structures in the 0.65 – 55 μm range



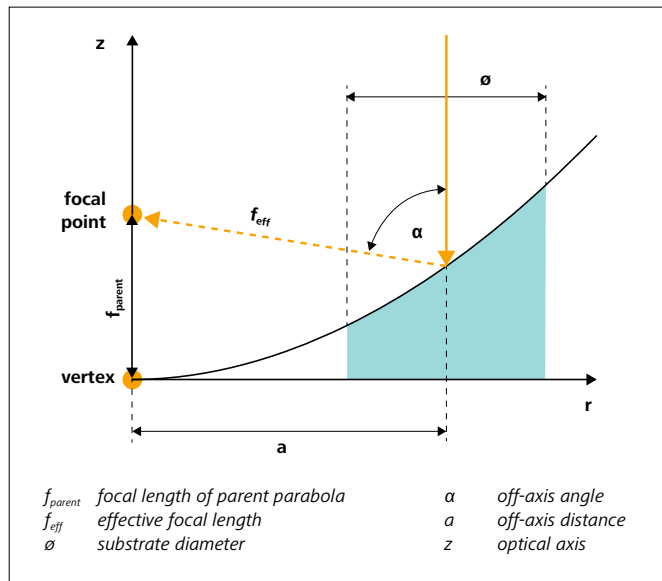
Figure 12: Parabolic substrate in production process, before (l.) and after lapping and polishing (r.)



Figure 13: Robotic cleaning and inspection

## Off-Axis Surfaces

An off-axis surface can be seen as a section of a bigger on-axis surface. The focal point still is on the original optical axis but not the center of the section. Instead, it is located off-axis. Off-axis surfaces derived from aspheres are described by the mentioned equation, the off-axis distance  $a$  and/or the off-axis angle  $\alpha$ .



**Figure 14:** Schematic drawing of an off-axis parabola (OAP)

Please provide the following specifications when making inquiries:

- Geometry data
- Tested area
- Focal length (effective or parent parabola focal length)
- Off-axis angle or off-axis distance
- Material
- Necessary surface imperfection tolerance according to ISO 10110 (3/; 4/; 5/; etc.)
- Coating

The focal length of the parent parabola ( $f_{parent}$ ) is measured from the vertex on the optical axis. For the off-axis parabola (OAP), an effective focal length ( $f_{eff}$ ) is introduced. The off-axis distance is measured from the optical axis to the middle of the OAP. The radius  $R$  denotes the radius of curvature in the vertex of the parent parabola. The conic constant  $k$  is -1.

In principle, an off-axis substrate can always be mechanically cut from an on-axis substrate. The alternative way is direct manufacturing (parallel configuration). Depending on the size and tolerances, both ways are possible.

Basically, LAYERTEC's off-axis surfaces are manufactured in the direct way. Manufacturing from the parent parabola is currently limited to  $\phi = 300$  mm and is only carried out on request.

## Free Form Surfaces

In general, free form surfaces do not exhibit any symmetries. They are always customer specific and can be defined by an equation. Additional specification of tabulated sagitta values is highly recommended. Free form surfaces are manufactured as single pieces. With respect to machining, the production of an off-axis asphere from a single piece represents a free form as well. Table 3 shows LAYERTEC's production dimensions and tolerances for free form surfaces.

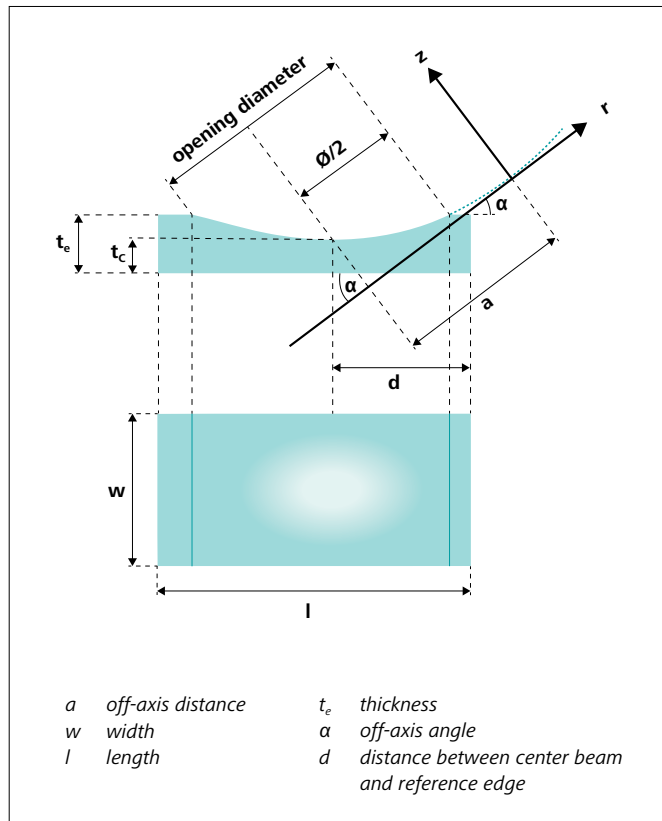


Figure 15: Basic dimensional parameters of a free form substrate

Table 3: Dimensions and tolerances of free form substrates

	Dimension	Thickness
Ø	< 300 mm	±0.2 mm
w	< 300 mm	±0.1 mm
l	< 450 mm	±0.1 mm
α	< 45°	
t <sub>e</sub>	< 80 mm	±0.1 mm
d		±0.1 mm
Surface form tolerances (P-V)		λ/4 (λ/10 on request)
Roughness		< 0.3 nm

## Materials

The surface imperfection tolerance and the final tolerances strongly depend on the material of the substrate. LAYERTEC uses a process optimized for Fused Silica. Materials like Zerodur®, ULE® or N-BK7® may be used in special cases.

## Measurement

Measuring aspheric surfaces requires sophisticated devices. LAYERTEC applies 2 different measurement principles. See also page 152 ff.

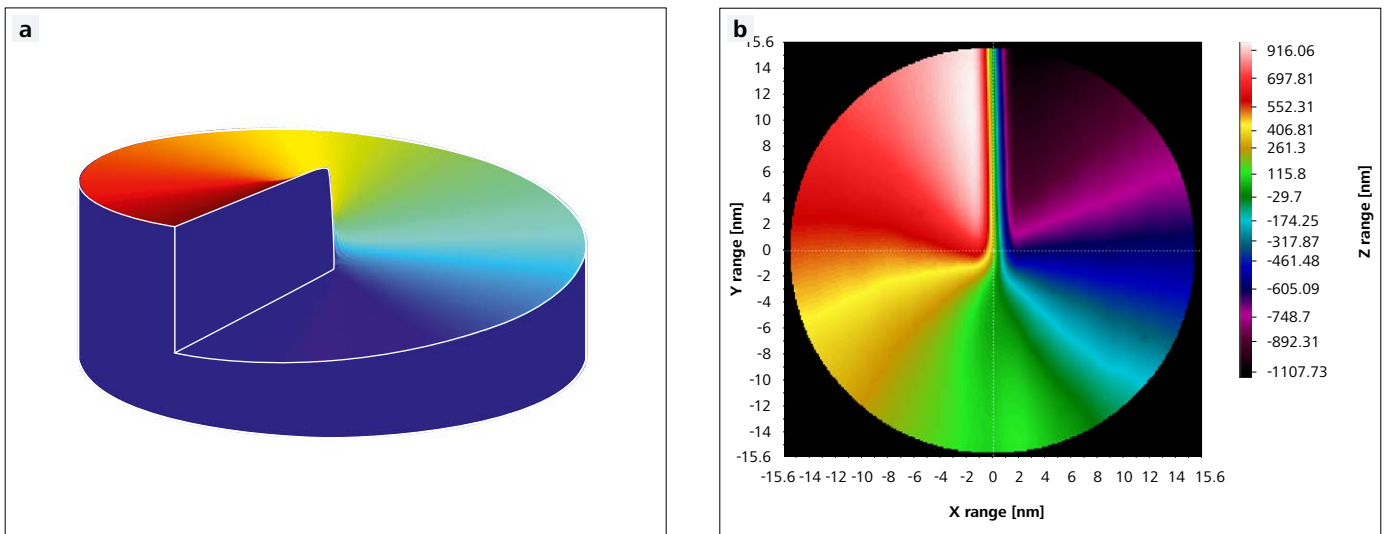
- Single point interferometer:  
Contactless measurement of the surface, measuring the surface point by point. Precision λ/4 on ≤ Ø 420 mm.
- Interferometer with reference surface:  
The surface is compared to a known reference surface. Precision < 50 nm, on Ø ≤ 300 mm. Concave surfaces preferred.

## Special Surfaces

Particular applications in optics exhibit a demand for optical surfaces that are far away from flat, spherical or even aspheric surfaces. Thus, in the following such surfaces are referred to as special surfaces.

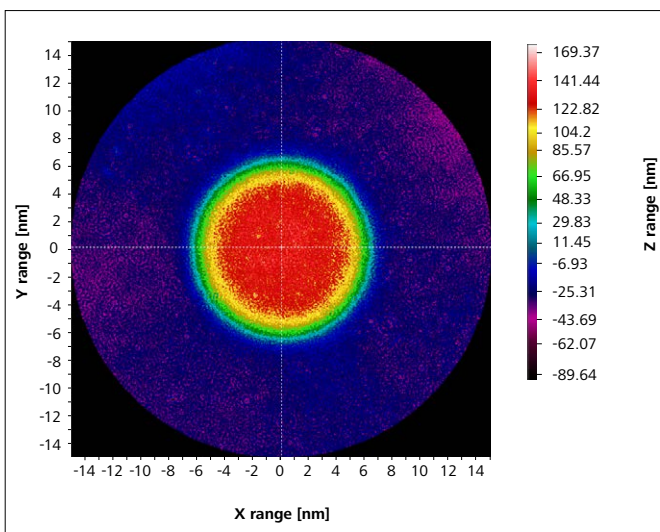
The fabrication of these special surfaces can typically not be addressed with conventional manufacturing technologies in optics. At LAYERTEC a local correction technique with a footprint of  $\approx 1$  mm in diameter is used. This allows the fabrication of profiles with typical lateral features above 1 mm. In the set-up the handled substrates are up to 400 mm in diameter. Surface profiles are applied with a typical fabrication error below 25 nm (along the z-axis). Furthermore, this technique allows a complete processing of the optical surface. In contrast to most local correction techniques there is no need for a safety margin around substrate edges.

Optical vortices are a well-known example of a special surface. They are mainly used in the generation of laser beams with a spiral phase. The structure of an optical vortex is exemplary shown in figure 16a. With respect to the manufacturing of a vortex the main feature of such a profile can be found in the edge, showing a typical height of several 100 nm. In the fabrication process the footprint of the local polishing tool smears out this edge. Figure 16b shows the surface form deviation of a real substrate (30 mm in diameter) processed by LAYERTEC.



**Figure 16:** Vortex substrate  
a) Vortex side view  
b) Surface form deviation of a real substrate

Another application of special surfaces can be found in the compensation of thermal lenses. In this case the respective wavefront error caused by a thermal lens is translated into a surface form deviation of a transmissive or reflective optical element. Such a surface is then applied to a real optics counteracting the thermal lens in the stationary working regime of the application. A typical example of the surface form of such an element is shown in figure 17.



**Figure 17:** Surface form profile of an optical element counteracting a thermal lens

## Large Scale Optics

LAYERTEC offers large scale optics which are used for a variety of applications in industry (material processing, measurement, semiconductor industry, display production), science, medical and other areas. Processing technologies are offered for all common Fused Silica optics (special materials on request). LAYERTEC develops large optical components in cooperation with the customer from prototype to serial production. LAYERTEC has suitable measurement equipment to ensure the promised specifications.



Figure 18: Quality control of large scale optics



Figure 19: Examples for large scale optics

### Optical Components

- Planar optics
- Spheres
- Cylinders
- Aspheres, off-axis parabola
- Free-form optics

### Accuracy and quality of surfaces

- Planarity up to  $\lambda/20$
- Polishing level 4
- Roughness  $R_q \leq 0.5$  nm
- Surface defects down to 1 ppm of checking area

### Technologies for substrate fabrication

- CNC grinding up to 2000 mm
- Polishing (CNC and classical) up to 2000 mm
- Interferometry (flat and cylindrical surfaces) up to 2000 mm
- Roughness measurement (tactile and optical) up to 2000 mm
- Multi-sensor coordinate measuring up to 2000 mm
- Ultrasonic cleaning technology up to 1200 mm

### Optical Coating Technologies

- IAD up to 1200 mm
- Magnetron-sputtering up to 600 mm
- Characterization of optical coatings (OPO-CRD, PCI, LIDT)

Scanning Mirrors & Lightweight Structures

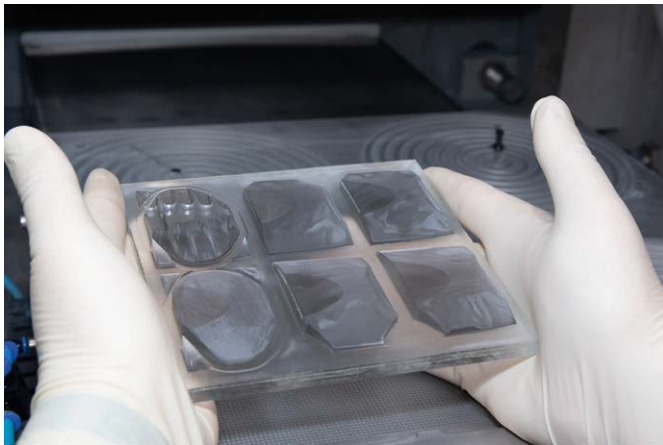


Figure 20: Scanning mirrors during CNC production



Figure 21: Examples for different types of scanning mirrors

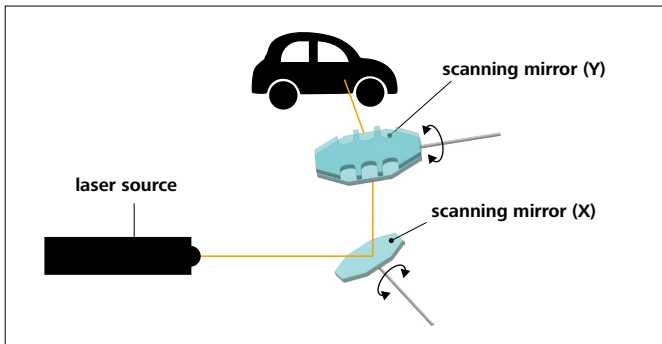


Figure 22: Working principle of the scanner mirror

Scanning mirrors are special deflection mirrors with an optical function surface. By rotating the mirror, the direction of the reflected beam can be changed. With a single mirror, a line can be scanned. With a combination of 2 scanning mirrors, whose axes of rotation are offset by 90 degrees, a two-dimensional surface can be scanned.

Various CNC machining technologies are available for the production of scanner mirrors. Standard scanner mirrors are not yet lightweight components, but normal "solid" mirrors with "normal" dynamic requirements. However, these can be optimized according to customer requirements in terms of weight (lightweight scanner mirrors) or speed of movement (high-speed scanner mirrors).

Lightweight and high-speed scanner mirrors are characterized by herringbone-like structures, which are responsible for reducing the mass moment of inertia by up to a factor of 4 (compared to "solid" material). The resonant frequency is increased by up to a factor of 1.5 by this step, and the dynamic deformation is reduced by up to a factor of 1.5. These special shapes are used when a very fast change in the direction of movement of the laser beam over the workpiece surface is desired.

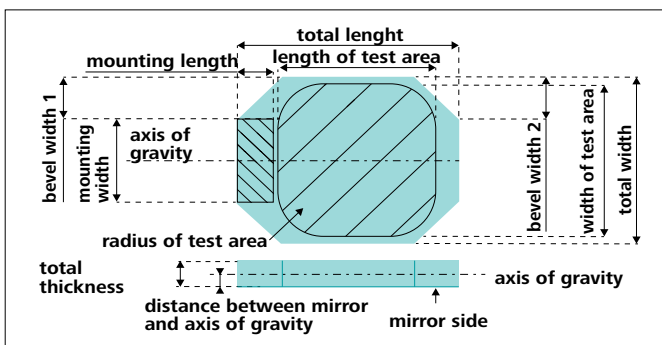


Figure 23: Technical drawing of a scanner mirror

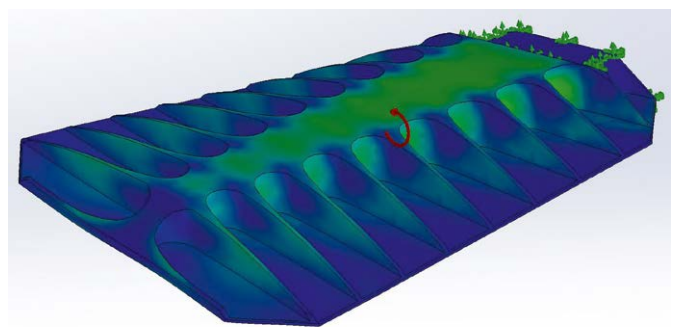


Figure 24: FEM simulation of mechanical deformation (blue = "stress-free", green = "stresses due to deformation", red arrow = "torsional direction"). The stresses in the component are homogeneously distributed, there are no stress peaks. This ensures optimum performance.



**Table 4:** Specification of Lightweight Structures

Fused Silica	Standard		Lightweight		High Speed	
	small	large	small	large	small	large
Limits for mirror sizes						
Total width [mm]	20	80	40	80	15	40
Total length [mm]	20	80	40	80	15	40
Total thickness [mm]	3.2	6.35	6.35	9.5	2.5	6.35
Moment of inertia [g×mm <sup>2</sup> ]	100	8000	120	2000	13	120
Resonance frequency in direction of rotation [Hz]	15000	3000	8000	4000	20000	8000
Max. Stress at 10 000 rad/s <sup>2</sup> [N/mm <sup>2</sup> ]*	0.03	0.8	0.005	0.1	0.03	0.06
Form deviation at 10 000 rad/s <sup>2</sup> [nm]	100	450	50	300	5	50

\* The angular acceleration of 10 000 rad/s<sup>2</sup> corresponds approximately to a frequency of 22 Hz when the amplitude is ±30°. This angular acceleration is an example value to indicate stress and deformation. The stress and deformation in the substrate are assumed to be linear with respect to angular acceleration. Thus, doubling the angular acceleration will lead to a doubled amount of dynamic deformation. Furthermore, the angular acceleration scales linearly with a change in the modulation amplitude and quadratically with respect to a change in frequency.

Coating is done by magnetron sputtering, IBS or evaporation and can be customized according to customer requirements.

## Etalons & Waveplates

### Etalons

As a kind of Fabry-Pérot interferometer, the etalon is typically made of a transparent plate with two reflective surfaces. Its transmittance spectrum, as a function of wavelength, exhibits peaks of high transmittance corresponding to resonances of the etalon. Etalons are widely used in telecommunication, lasers and spectroscopy for controlling and measuring the wavelength of laser sources. LAYERTEC offers etalons of customized diameters and various materials depending on the wavelength range. Thicknesses down to 50 µm and a parallelism < 1 arcsec are possible subject to the diameter. Do not hesitate to contact us for the customized diameter and thickness you need.

**Table 5:** Specifications of etalons

	Thickness			Parallelism
	∅ = 50 mm	∅ = 25 mm	∅ = 12.7 mm	
Fused Silica	≥ 200 µm	≥ 100 µm	≥ 50 µm	< 1 arcsec
YAG	≥ 200 µm	≥ 90 µm	≥ 50 µm	< 1 arcsec
CaF <sub>2</sub>	—	≥ 300 µm	≥ 100 µm	< 5 arcsec

### Waveplates

LAYERTEC offers customer specific retardation plates made of crystalline quartz. Due to requirements for mechanical stability, there is a minimum feasible thickness depending on diameter. Thus, there is a constraint with respect to the shortest available wavelength for a given waveplate order. For selected geometries LAYERTEC provides effective zero-order waveplates. These waveplates are made by combining two individual waveplates with alignment of the fast axis of one plate to the slow axis of the other. The resulting net retardation of this assembly is the difference between the two retardations. For two frequently requested diameters, examples are given below. Other diameters are available on request. Please contact us for further information.

**Table 6:** Specifications of waveplates made of crystalline quartz

Order	∅ = 25 mm	∅ = 18 mm	Thickness Tolerance	Parallelism
λ/2	Available wavelengths			
K = 0	—	λ > 1530 nm	±1 µm	< 1 arcsec
K = 1	λ > 720 nm	λ > 560 nm	±1 µm	< 1 arcsec
K = 2	λ > 450 nm	λ > 350 nm	±1 µm	< 1 arcsec
λ/4	Available wavelengths			
K = 1	λ > 860 nm	λ > 660 nm	±1 µm	< 1 arcsec
K = 2	λ > 500 nm	λ > 380 nm	±1 µm	< 1 arcsec

# Measurement Tools for Testing Substrates

## Surface Form Deviations

Any machined substrate exhibits surface form deviations from its theoretical design. The effect of these deviations on the optical functionality of the optics can be categorized with respect to the spatial dimension of the deviations. The following section refers to deviations of the optically active surface.

The inverse length of this spatial dimension – the spatial frequency – is used to mathematically describe the different kinds of deviations. A rough classification of deviations distinguishes between Form (low spatial frequencies), Waviness (mid-spatial frequencies) and Roughness (high spatial frequencies).

Form deviations affect the wavefront of the passing light while leaving the direction of propagation nearly unchanged. They lead to a distortion of the image or a significant alteration of the focal intensity distribution near the optical axis.

Waviness deviations also conserve the total energy of the propagating beam but mainly affect focal regions away from the optical axis. For example, periodical deviations in this frequency band can give rise to the formation of parasitic secondary foci.

Finally, roughness affects the propagating wavefront on spatially small regions. These disturbances lead to an effective scattering of energy off the direction of the main beam. Thus, there is a widespread intensity background resulting in a reduction of image contrast.

A quantitative distinction of form, waviness and roughness involves different optical and geometrical parameters, mainly the operating wavelength as well as numerical aperture and focal length. Thus, the same surface form deviation may lead to a significantly different optical behavior when used in different applications.

## Surface Form Measurement

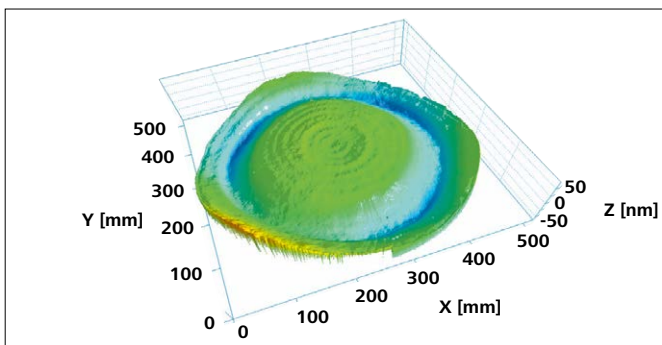
For the measurement of surface form deviation, LAYERTEC is equipped with laser interferometers and special interferometer set-ups for plane, spherical, cylindrical, aspherical and parabolic surfaces. Additionally, a tactile measurement device (Taylor Hobson PGI 1240 Asphere<sup>®</sup>) is available for general aspheric and ground surfaces. Besides the purpose of quality control, surface form measurement is a key function for the zonal polishing technology established at LAYERTEC.

### Abbreviations

- P-V: The peak-to-valley height difference
- ROC: Radius of curvature of a spherically or cylindrically curved surface.
- $\lambda$ : operating wavelength of the laser interferometer (e.g. 546 nm). The P-V value is stated in a fractional amount of  $\lambda$ . The actual value of  $\lambda$  is stated in measurement reports.

For detailed information about the standards concerning specification of surface form deviation please see ISO 10110-5.

### Accuracy of Interferometric Measurements



**Figure 1:** Height map of a flat surface with a diameter of  $\varnothing = 520$  mm polished and measured at LAYERTEC. The P-V value is  $\lambda/10$  over the full aperture ( $\varnothing = 500$  mm inspection area) after zonal correction.

Without special calibration procedures, the accuracy of an interferometric measurement is only as accurate as the reference surface. Calibration can increase the accuracy by a factor of 2 or more. Furthermore, the accuracy is influenced by the size of the measured area and in case of a curved surface by the radius of curvature itself. The accuracy values stated as “P-V better than ...” in the following articles are guaranteed values. Very often accuracies of  $\lambda/20$  or better will be achieved.

### Standard Measurements

In general, the form tolerance of spherical and plane optics with diameters  $\varnothing \leq 100$  mm can be measured with an accuracy of P-V better than  $\lambda/10$  by using ZYGO<sup>®</sup> Fizeau interferometers. To cover a measurement range of ROC =  $\pm 1200$  mm over an aperture up to  $\varnothing = 100$  mm, LAYERTEC uses high precision Fizeau objectives. In many cases, a higher accuracy up to P-V =  $\lambda/30$  is possible. Measurement reports can be provided on request.

## Large Radius Test (LRT)

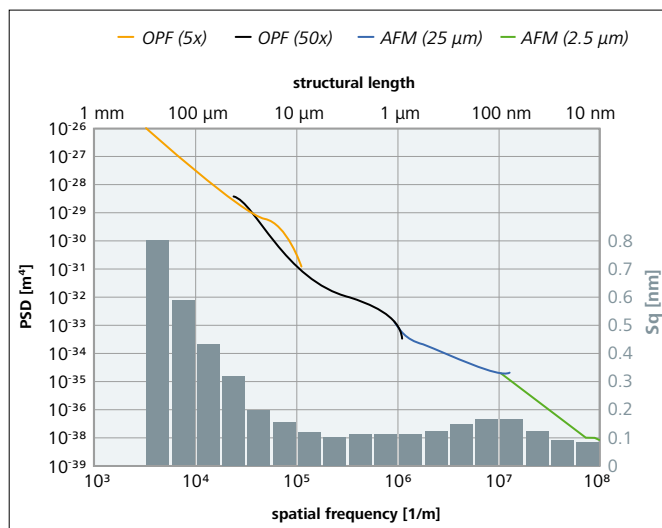
Surfaces with radii of curvature above  $\pm 1200$  mm are tested with a special Fizeau zoom lens set-up called Large Radius Test (LRT). This set-up was developed by DIOPTIC GmbH in cooperation with LAYERTEC. Its operating range is  $ROC = \pm 2000 \dots \pm 20\,000$  mm at working distances lower than 500 mm. The accuracy is guaranteed as  $P-V = \lambda/8$  over  $\varnothing \leq 100$  mm, but typically it is better than  $P-V = \lambda/15$ . LRT has the advantages that only one Fizeau-objective is needed to cover a wide range of radii of curvature and that the working distance is kept small. This reduces the influence of disturbing air turbulences during the measurement.

## Surface Roughness Measurement

In many applications, scattered light represents a crucial restriction to the proper operation of an optical device. On the one hand, scattered light reduces the intensity of the light propagating through the system, leading to optical losses. On the other hand, it also leads to a noise background of light reducing the overall contrast of imaging optics. The amount of scattered light produced by an optic is mainly determined by its surface roughness. Thus, requirements to the surface roughness are often necessary to guarantee the proper operation of a device. For a quantitative comparison, the RMS roughness is a widely-used measure to specify optical surfaces. It is defined as the root-mean-square of the surface height profile  $z$ :

$$R_q = \sqrt{\frac{1}{L} \int z^2(x) dx}, \quad S_q = \sqrt{\frac{1}{A} \iint z^2(x, y) dx dy}$$

Here the letter 'R' indicates line scans according to ISO 4287 while the letter 'S' refers to the evaluation of a scan on a two-dimensional measurement area as described in ISO 25178. The scan field size (maximum spatial frequency) as well as the resolution of the measurement set-up (minimum spatial frequency) affect the numerical value of  $R_q$  and  $S_q$ . For that reason, the specification of an RMS roughness value requires the specification of the underlying band of spatial frequencies as well. Often, technical drawings are lacking information on the frequency band and thus become meaningless. By using the power spectral density (PSD) of a surface, the distribution of the surface roughness with respect to the spatial frequencies becomes obvious. The RMS value of a surface simply follows from integration of the PSD over the given spatial frequency band. Generally, the scattered light of optical surfaces produced for the UV-NIR spectral range is dominated by spatial frequencies ranging from 0.01 to 10  $\mu\text{m}^{-1}$ .



**Figure 2:** PSD of a LAYERTEC standard polish obtained by combining measurements using AFM and optical profiler (OPF). The right axis shows  $S_q$  values on a logarithmic grid over spatial frequencies. To obtain the total roughness  $S_{q\text{tot}}$  over multiple bars  $S_{qi}$ , square values have to be added  $S_{q\text{tot}} = S_{q1}^2 + S_{q2}^2 + \dots$

At LAYERTEC, different phase shifting and phase-shift masking optical surface profiler (Sensofar<sup>®</sup>, 4DTechnology<sup>®</sup>) and an atomic force microscope (AFM) DI Nanoscope 3100<sup>®</sup> are used to cover the given frequency band. The optical profilers cover low spatial frequencies and have an acquisition time of a few seconds. It is used for the general inspection of the polishing process and is able to identify surface defects and inhomogeneities. The AFM addresses high spatial frequencies using scan field sizes of  $2.5 \times 2.5 \mu\text{m}^2$  and  $25 \times 25 \mu\text{m}^2$  and has an acquisition time of 10 to 30 minutes. Therefore, it is used primarily for the development of polishing processes. It further serves to monitor the LAYERTEC premium-polishing process and especially optics for UV applications with  $S_q < 0.2$  nm (spatial bandwidth: 7 – 1200 nm) with respect to quality control. Measurement reports are available on request.

## Measurement Systems for Testing Substrates

### Large Aperture Metrology

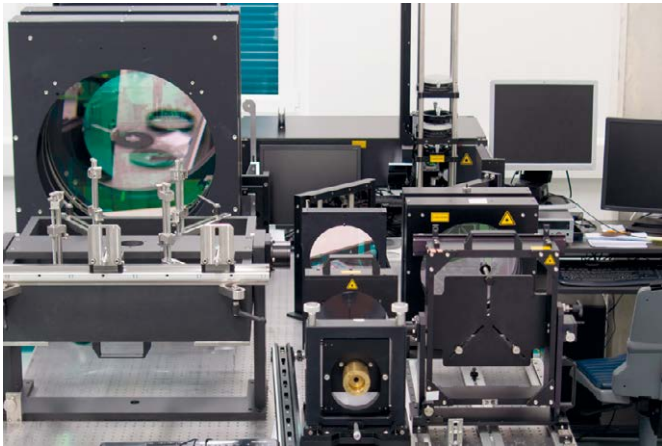


Figure 3: Interferometry of large surfaces

Especially for laser optics with large dimensions, LAYERTEC uses a high performance Fizeau interferometer and a Twyman-Green interferometer within the following measurement ranges:

- Plane surfaces:  $\varnothing \leq 300$  mm with an accuracy up to  $\lambda/20$  (633 nm) and  $\varnothing \leq 600$  mm better than  $\lambda/10$
- Spherical surfaces:  $\varnothing \leq 600$  mm with an accuracy better than  $\lambda/10$  (633 nm)
- Parabolic surfaces:  $\varnothing \leq 300$  mm full aperture measurement with an accuracy up to  $\lambda/10$  (633 nm)

### Contactless Metrology

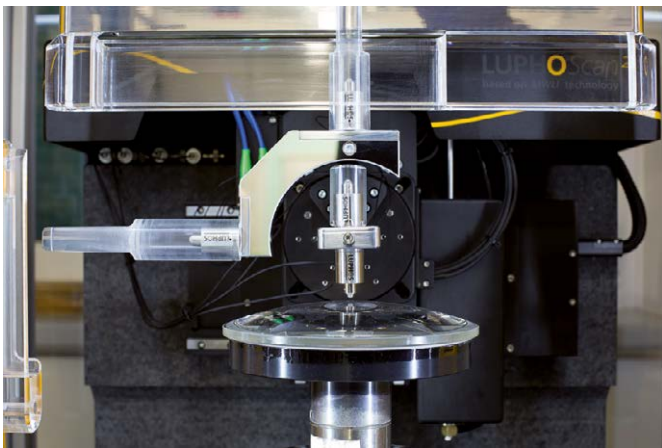


Figure 4: LumphoScan® metrology system

The metrology system LumphoScan®, developed by Lumpho GmbH, allows an ultra-high precision measurement of distance and surface form. The unique system combines many advantages of other distance measurement systems without their disadvantages of necessary contact, small working distance or tiny working range. This technology allows the determination of the topology of different objects down to the nanometer range.

Highly reflective objects as mirrors or metal coated substrates can be measured as well as transparent objects providing only weak reflectance (glass lenses, substrates).

Due to its measurement range, it is possible to resolve structures of up to 1 mm height with a precision of  $\pm 5$  nm. Especially, topological errors of aspheric surfaces can be exactly determined and used for a correction of the form parameters during the polishing process.

### Tactile Surface Profiler

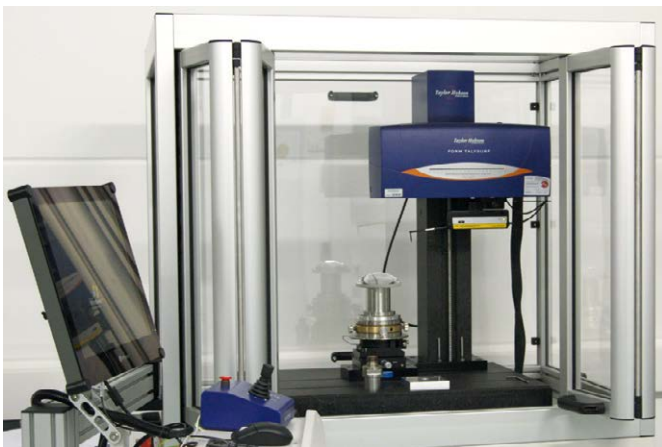


Figure 5: Taylor Hobson Talysurf PGI 1240®

The Talysurf PGI 1240® is a tactile surface profile measuring tool used to characterize strongly curved surfaces. A small tip is in contact with the surface and moves along a line while its vertical displacement is measured.

The measurement principle is independent of surface topology or optical properties such as coatings or thin contaminations, which often prevent direct interferometry. The vertical accuracy depends on the gradient of the surface and can reach values of 500 nm, which corresponds to  $\approx \lambda$  (633 nm).

LAYERTEC uses this tool for measurements of small to mid-size non-spherical surfaces up to a diameter of 200 mm.

## Optical Profilometry

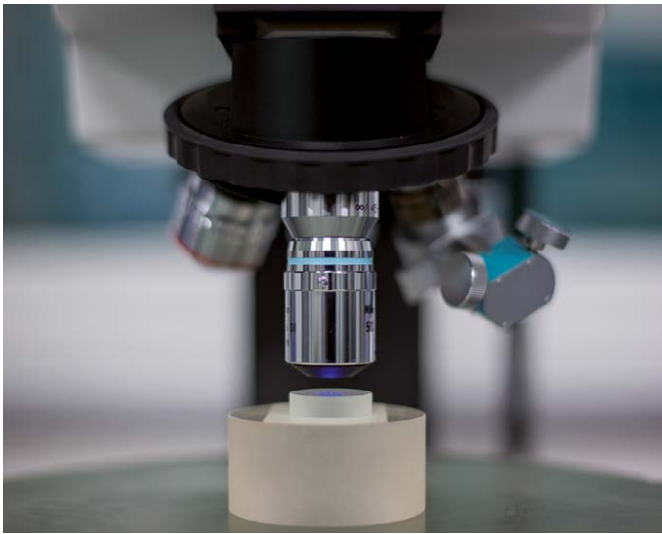


Figure 6: Optical profiler Sensofar®

A 3D optical surface profiler (Sensofar®) based on a white light interferometer is used to visualize the surface form and roughness of our substrates. The profiler is furthermore applied for the characterization of surface defects and other structures in the range of sizes from 0.5  $\mu\text{m}$  up to 100  $\mu\text{m}$ .

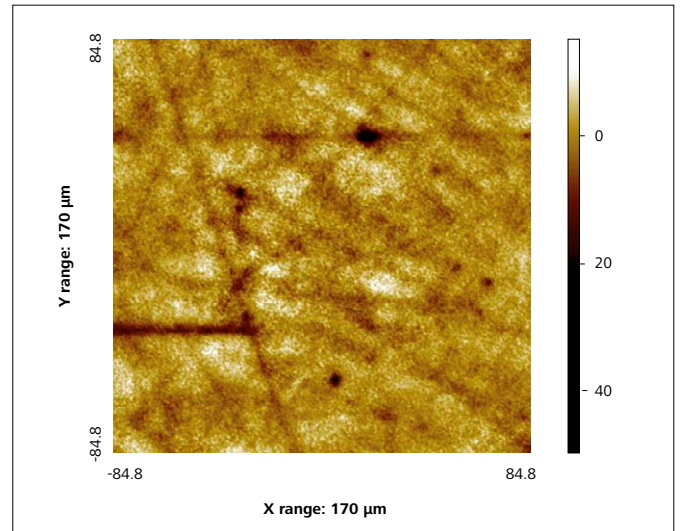


Figure 7: Surface defects visualized by the optical profiler

## Atomic Force Microscopy



Figure 8: DI Nanoscope 3100 AFM®

LAYERTEC utilizes an atomic force microscope (AFM) with a measurement range between 1  $\mu\text{m}$  and 25  $\mu\text{m}$ . It is used to control the special polishing processes for surface roughness values below  $S_q \leq 0.5 \text{ nm}$  as well as to provide inspection reports on request.

## Defect Analysis

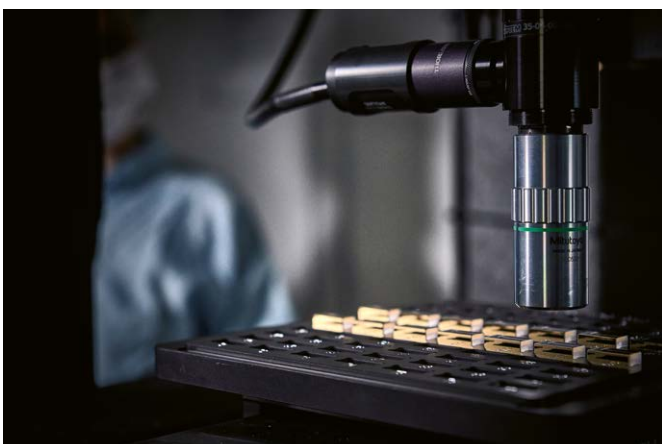


Figure 9: Defect inspection system for optical components

LAYERTEC has developed an automated measurement system for the detection and analysis of defects and scratches on optical surfaces. This system enables LAYERTEC to classify defect sizes according to ISO 10110-7. Thus, quality control procedures, such as final inspection, are facilitated, especially for high quality optics with defects specified below 25  $\mu\text{m}$ .

# Optical Coatings

## Chapter Index

<b>Coating Technologies .....</b>	<b>157</b>
Thermal and E-Beam Evaporation .....	157
Sputtering .....	158
<b>Optical Interference Coatings .....</b>	<b>160</b>
Basics .....	160
Antireflective Coatings (AR) .....	161
Mirrors and Partial Reflectors .....	162
Dielectric Broadband Coatings .....	162
Optical Losses .....	163
Stress .....	163
Angle Shift .....	164
Polarization Effects .....	164
Documentation of Coating Performance at LAYERTEC .....	165
<b>Metallic Coatings .....</b>	<b>166</b>
Silver .....	166
Gold .....	166
Aluminum .....	166
Chromium .....	166
Protective Layers .....	166
<b>Metal-Dielectric Coatings .....</b>	<b>167</b>
<b>Measurement Tools for Optical Coatings .....</b>	<b>168</b>
Spectral Photometry .....	168
Cavity Ring-Down Spectroscopy .....	168
Laser-Induced Damage Threshold (LIDT) .....	172
Absorption Behavior .....	174
Defect Inspection System for Coatings .....	175

# Coating Technologies

There are four basic processes that have been developed since about 1930. Besides layer deposition by dipping (sol-gel layers) and layer deposition from the gas phase (atomic layer deposition), only two technologies currently dominate the industry:

1. Layer deposition by evaporation of the layer forming materials in vacuum
2. Layer deposition by sputtering (impact processes)

LAYERTEC strives to offer the most effective, cost-efficient coating method for the respective application in direct customer contact.













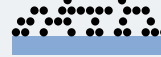























	 Thermal Evaporation	 Ion Assisted Evaporation	 Magnetron Sputtering	 Ion Beam Sputtering
Particle energy during deposition				
Substrate temperature required during deposition				
Coating structure				
Coating tension				
Scattered light				
Climatic and mechanical stability				
Coatable surface area (Chamber size)				
Coating accuracy				

Figure 1: Overview of the coating technologies possible at LAYERTEC

## Thermal and E-Beam Evaporation

### Working Principle

Thermal and electron beam evaporation are the most common techniques for the production of optical coatings. LAYERTEC uses these techniques mainly for UV coatings. The evaporation sources are mounted at the bottom of the evaporation chamber. They contain the coating material which is heated by resistive heating (thermal evaporation) or by an electron gun (e-beam evaporation).

The method of heating depends on the material properties (e.g. the melting point) and the optical specifications. The substrates are mounted on a rotating substrate holder at the top of the evaporation chamber. Rotation of the substrates is necessary to ensure coating homogeneity. The substrates must be heated to a temperature of 150 – 400°C, depending on the substrate and coating materials. This provides low absorption losses and good adhesion of the coating to the substrates.

Ion guns are used to get more compact layers. LAYERTEC is equipped with several evaporation machines covering the whole bandwidth of the above-mentioned techniques from simple thermal evaporation to ion assisted deposition (IAD) using the APS pro® and LION® ion sources.

APS pro® and LION® are trademarks of Bühler Alzenau GmbH.

## Properties of Evaporation Coatings

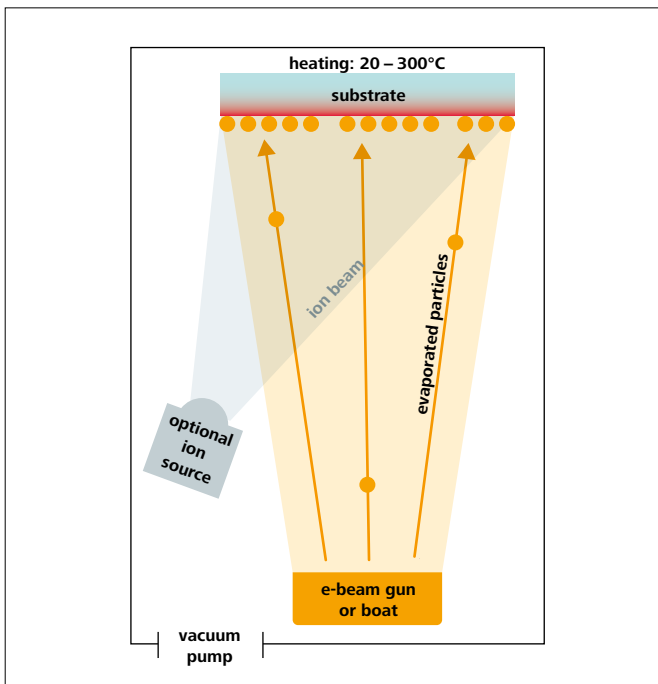


Figure 2: Schematic drawing of an evaporation plant

The energy of the film forming particles is very low ( $\approx 1$  eV). That is why the mobility of the particles must be enhanced by heating the substrates. The packing density of standard evaporated coatings is relatively low and the layers often contain micro-crystallites. This results in relatively high scattering losses (some tenth of a percent to some percent, depending on the wavelength). Moreover, atmospheric water vapor can diffuse in and out of the coating depending on temperature and humidity, resulting in a shift of the reflectance bands by  $\approx 1.5\%$  of the wavelength. Shift-free, i.e. dense, evaporated coatings can be produced by IAD using the APS pro<sup>®</sup> and LION<sup>®</sup> ion sources which provide very high ion current densities. Nevertheless, evaporated coatings have also high laser damage thresholds and low absorption. They are widely used in lasers and other optical devices.

## Sputtering

### Working Principle

In general, the term “sputtering” refers to the extraction of particles (atoms, ions or molecules) from a solid by ion bombardment. Ions are accelerated towards a target and collide with the target atoms. The original ions as well as recoiled particles, move through the material, collide with other atoms and so on. Most of the ions and recoiled atoms remain within the material, but a certain fraction of the recoiled atoms is scattered towards the surface by this multiple collision process. These particles leave the target and may then move to the substrates and build up a thin film.

### Properties of Sputtered Coatings

Because of the high kinetic energy ( $\approx 10$  eV), i.e. high mobility of the film forming particles, sputtered layers exhibit:

- An amorphous microstructure
- A high packing density (which is close to that of bulk materials)

These structural characteristics result in very advantageous optical properties such as:

- Low losses due to scattered light
- High stability of the optical parameters under various environmental conditions due to the blocking of water diffusion
- High laser-induced damage thresholds
- High mechanical stability

LAYERTEC currently operates over 40 magnetron and IBS systems, so that the optimum deposition technology can be selected for each customer application. The maximum substrate diameter for IBS sputtering is currently 30 cm, for magnetron sputtering 60 cm. The competitions of the SPIE Laser Damage conference of the last years show that each coating technology offers advantages for certain applications. Suitable for your specifications, LAYERTEC’s coating engineers select the appropriate method.



## Magnetron Sputtering

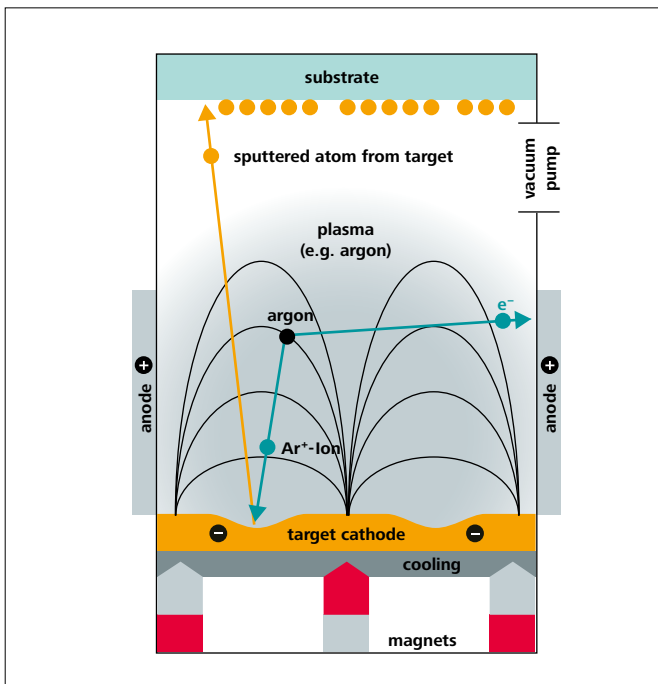


Figure 3: Schematic drawing of magnetron sputtering

Ions are delivered by a gas discharge which burns in front of the target. It may be excited either by a direct voltage (DC-sputtering) or by an alternating voltage (RF-sputtering). In the case of DC-sputtering the target is a disk of a high purity metal (e.g. titanium). Adding a reactive gas to the gas discharge (e.g. oxygen) results in the formation of the corresponding compounds (e.g. oxides). For RF-sputtering, dielectric compounds (e.g. titanium dioxide) can also be used as targets.

Developments at LAYERTEC have taken magnetron sputtering from a laboratory technique to a very efficient industrial process, which yields coatings with outstanding properties especially in the VIS and NIR spectral range. The largest magnetron sputtering machine can coat substrates up to a diameter of 600 mm.

## Ion Beam Sputtering

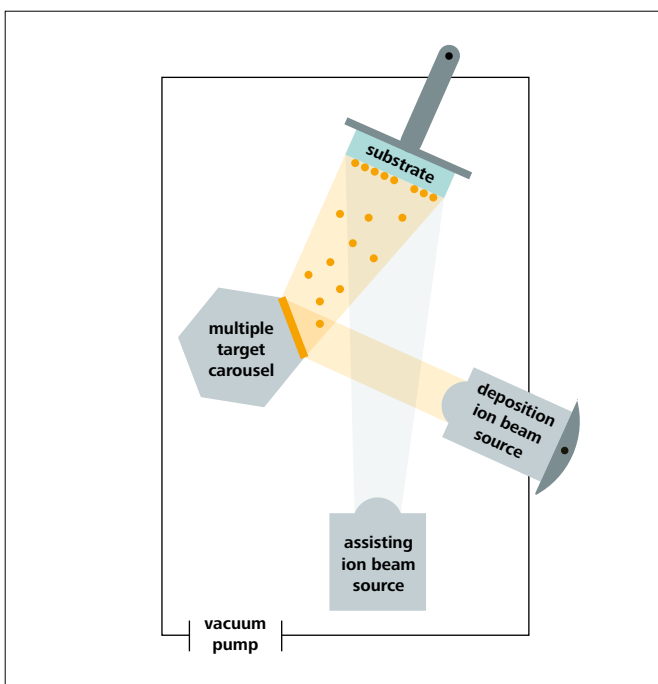


Figure 4: Schematic drawing of ion beam sputtering (IBS)

This technique uses a separate ion source to generate the ions. To avoid contaminations, RF-generators are used in modern IBS machines. The reactive gas (oxygen) is in most cases provided by a second ion source. This results in a better reactivity of the particles and in more compact layers.

The main difference between magnetron sputtering and ion beam sputtering is that ion generation, target and substrates are completely separated in the IBS process while they are very close to each other in the magnetron sputter process.

## Optical Interference Coatings

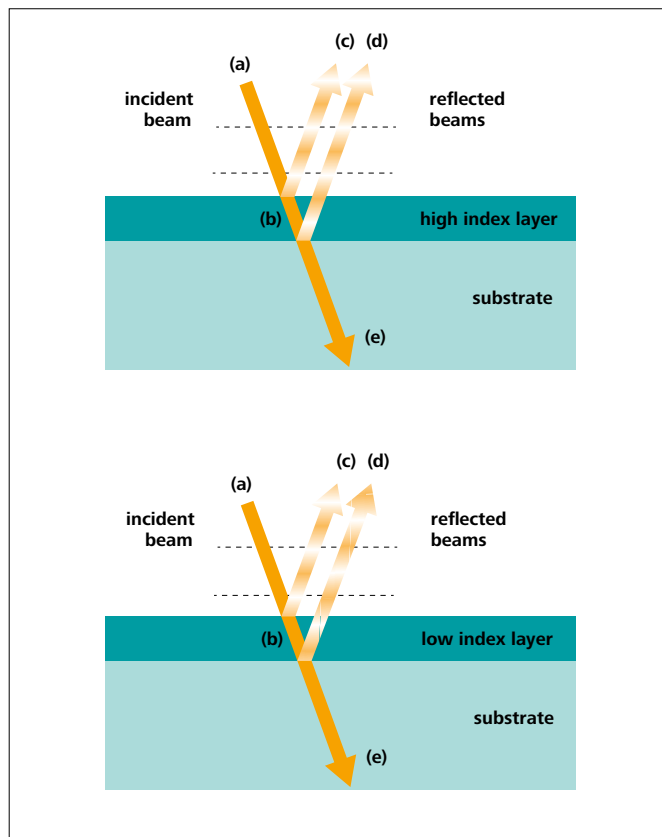
The purpose of optical coatings is to change the reflectance of optical surfaces. According to the materials used, metallic and dielectric coatings can be distinguished. Metallic coatings are used for reflectors and neutral density filters. The achievable reflectance is given by the properties of the metal. Common metals used for optical applications are described on page 166. Dielectric coatings use optical interference to change the reflectance of the coated surfaces. Another advantage is that the materials used in these coatings show very low absorption. The reflectance of optical surfaces can be varied from approximately zero (antireflection coatings) to nearly 100 % (low loss mirrors with  $R > 99.999\%$ ) using optical interference coatings. These reflectance values are achieved only for a certain wavelength or a wavelength range.

The effect of optical coatings is based on three physical effects:

1. Reflection of light at refractive index boundaries
2. Interference of partial waves within the structure
3. Exploitation of phase shift of the reflected waves at refractive index boundaries

Such structures are possible if transparent layers with plane-parallel interfaces can be deposited with a thickness of less than approx.  $1\ \mu\text{m}$ . Complex structures consist of alternating layers of several materials with specifically adjusted optical thickness.

### Basics



**Figure 1:** Schematic drawing to explain the interference effect of quarter-wave layers of a high index material and a low index material

The influence of a single dielectric layer on the reflectance of a surface is schematically shown in figure 1. An incident beam (a) is split into a transmitted beam (b) and a reflected beam (c) at the air-layer interface. The transmitted beam (b) is again split into a reflected beam (d) and a transmitted beam (e). The reflected beams (c) and (d) can interfere. In figure 1 the phase is represented by the shading of the reflected beams. The distance from "light-to-light" or "dark-to-dark" is the wavelength. Depending on the phase difference between the reflected beams, constructive or destructive interference may occur. The reflectance of the interface between the two media depends on the refractive indices of the media, the angle of incidence and the polarization of the light.

In general, it is described by the Fresnel equations:

$$R_s = \left( \frac{n_1 \cos \alpha - n_2 \cos \beta}{n_1 \cos \alpha + n_2 \cos \beta} \right)^2$$

$$R_p = \left( \frac{n_2 \cos \alpha - n_1 \cos \beta}{n_2 \cos \alpha + n_1 \cos \beta} \right)^2$$

$R_s$  ... reflectance for s-polarization  
 $R_p$  ... reflectance for p-polarization  
 $n_1$  ... refractive index of medium 1  
 $n_2$  ... refractive index of medium 2  
 $\alpha$  ... angle of incidence (AOI)  
 $\beta$  ... angle of refraction (AOR)

For normal incidence ( $\alpha = \beta = 0^\circ$ ) the equations can be reduced to the simple expression:

$$R = \left( \frac{n_2 - n_1}{n_2 + n_1} \right)^2$$

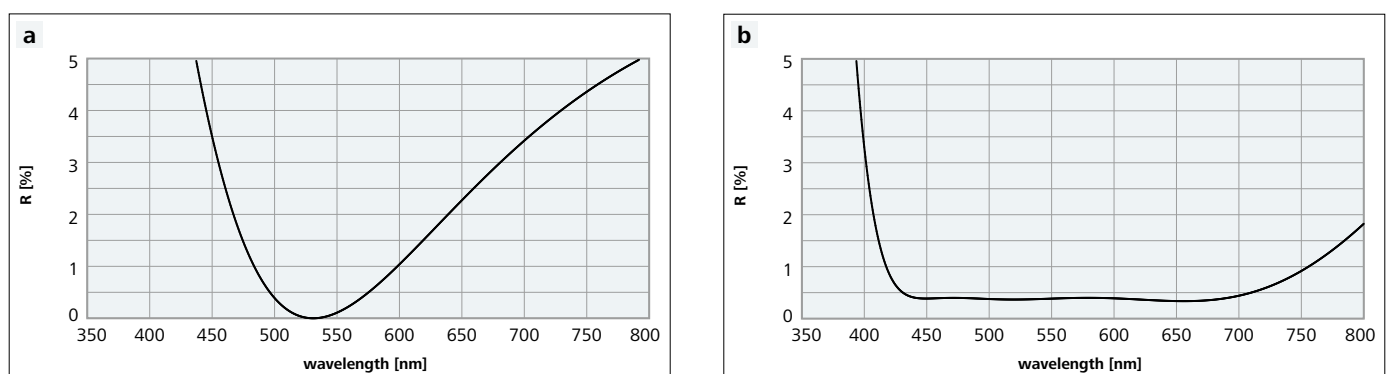
The phase difference between the beams (c) and (d) (see figure 1) is given by the optical thickness  $n \times t$  of the layer (the product of the refractive index  $n$  and the geometrical thickness  $t$ ). Furthermore, a phase shift of  $\pi$ , i.e. one half-wave, has to be taken into account, if light coming from a low index medium is reflected at the interface to a high index medium. Please refer to the literature cited on page 167 for a detailed explanation of the physics of optical interference coatings. Below are a few rules to help customers understand the optical properties of the coatings described in this catalog:

- High index layers increase the reflectance of the surface. The maximum reflectance for a given wavelength  $\lambda$  is reached for  $n \times t = \lambda/4$ . Only in the case of an optical thickness  $n \times t = \lambda/2$ , the reflectance of the surface does not change for this wavelength  $\lambda$ .
- Low index layers decrease the reflectance of the surface. The minimum reflectance for a given wavelength  $\lambda$  is reached for  $n \times t = \lambda/4$ . Only in the case of an optical thickness  $n \times t = \lambda/2$ , the reflectance of the surface does not change for this wavelength  $\lambda$ .

## Antireflective Coatings (AR)

A single low index layer can be used as a simple AR coating. The most common material for this purpose is magnesium fluoride with a refractive index of  $n = 1.38$  in the VIS and NIR. This material reduces the reflectance per surface to  $R \approx 1.8\%$  for Fused Silica and nearly zero for sapphire.

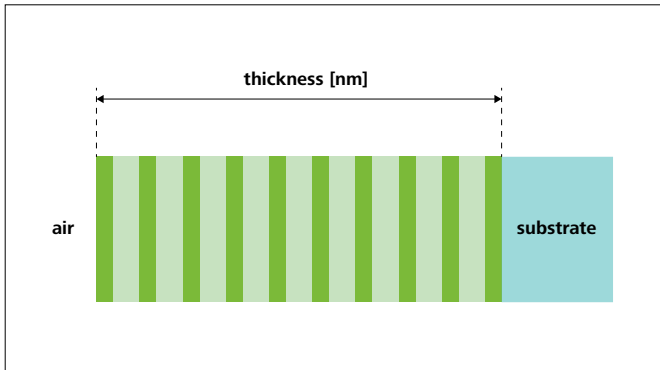
Single wavelength AR coatings consisting of 2 to 3 layers can be designed for all substrate materials to reduce the reflectance for the given wavelength to nearly zero. These coatings are used especially in laser applications. AR coatings for several wavelengths or for broad wavelength ranges are also possible and consist of 4 to 10 layers.



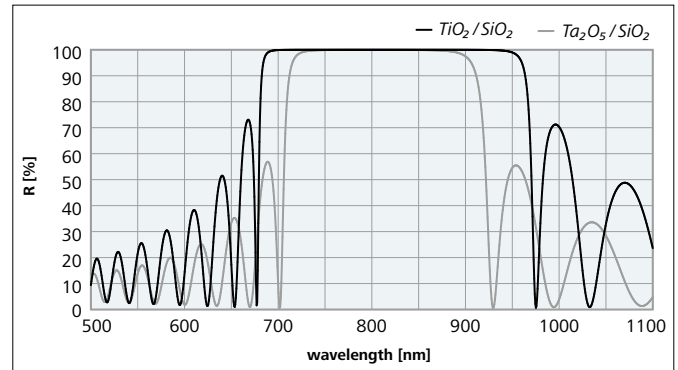
**Figure 2:** Schematic reflectance spectra:  
**a)** Single wavelength AR coating ("V-coating")  
**b)** Broadband AR coating

## Mirrors and Partial Reflectors

The most common mirror design is the so-called quarter-wave stack, i.e. a stack of alternating high and low index layers with equal optical thickness of  $n \cdot t = \lambda/4$  for the desired wavelength. This arrangement results in constructive interference of the reflected beams arising at each interface between the layers. The spectral width of the reflection band and the maximum reflectance for a given number of layer pairs depend on the ratio of the refractive indices of the layer materials. A large refractive index ratio results in a broad reflection band while a narrow reflection band can be produced using materials with a low refractive index ratio.



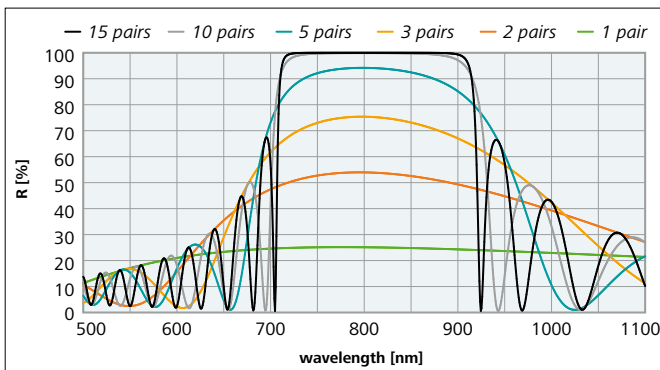
**Figure 3:** Schematic drawing of a quarter-wave stack consisting of layers with equal optical thickness of a high index material (dark green) and a low index material (light green)



**Figure 4:** Reflectance spectra of quarter-wave stacks consisting of 15 pairs of  $Ta_2O_5/SiO_2$  and  $TiO_2/SiO_2$

To visualize the effect of different refractive index ratios, figure 4 compares the reflectance spectra of quarter-wave stacks consisting of 15 pairs of  $Ta_2O_5 + SiO_2$  ( $\Delta n \approx 0.66$ ) and  $TiO_2/SiO_2$  ( $\Delta n \approx 0.91$ ) for 800 nm.

The theoretical reflectance will approach  $R = 100\%$  with an increasing number of layer pairs, assuming that ideal coatings have zero absorption and scattering losses. Partial reflectors with several discrete reflectance values between  $R = 0\%$  and  $R = 100\%$  can be manufactured using only a small number of layer pairs (see figure 5). Adding non-quarter-wave layers to a stack optimizes the reflectance to any desired value.



**Figure 5:** Calculated reflectance of quarter-wave stacks consisting of 1, 2, 3, 5, 10 and 15 layer pairs of  $Ta_2O_5/SiO_2$  for 800 nm

Figure 5 also shows that an increasing number of layer pairs results in steeper edges of the reflectance band. This is especially important for edge filters, i.e. mirrors with low reflectance side bands. Extremely steep edges require a large number of layer pairs which also results in a very high reflectance (HR). Extremely high reflectance values require very low optical losses. This can be achieved by using sputtering techniques.

## Dielectric Broadband Coatings

The first step to broadband mirrors and output couplers is to use coating materials with a large refractive index ratio. The bandwidth can be further increased by using special coating designs i.e. by using non-quarter-wave layers.

The easiest way is to combine two or more quarter-wave stacks with overlapping reflectance bands. However, this results in an increase of optical losses at the wavelengths where the bands overlap. Moreover, multiple stack designs cannot be used for ultrafast lasers because they induce pulse distortion.

LAYERTEC offers special all-dielectric broadband components for ultrafast lasers up to a bandwidth of one octave, i.e. 550 nm – 1100 nm (see page 49 f.)

An even larger bandwidth can be achieved using metals. However, the natural reflectance of metals is limited to 92 – 99 % (see page 166), but it can be increased by dielectric coatings. For such ultra-broadband metal-dielectric mirrors see page 76 and 87 ff.

## Optical Losses

Light, which impinges on an optical component is either reflected, transmitted, absorbed or scattered. From this basic point of view, the energy balance can be written in the simple equation

**R + T + A + S = 1** (with R ... Reflectance, T ... Transmittance, A ... Absorption and S ... Scattering).

In laser physics and precision optics absorption and scattering are summarized as optical losses because the absorbed and scattered part of the incoming light can no longer be used as a carrier of information or as an optical tool. In practice, the reflectance which can be achieved depends on the absorption and scattering losses of the optics.

Scattering losses increase drastically with decreasing wavelength, which can be described by the Mie theory (scattering by particles with diameters in the order of  $\lambda$ ,  $S \sim 1/\lambda^2$ ) and Rayleigh theory (scattering by particles with diameters  $< \lambda$ ,  $S \sim 1/\lambda^4$ ). Depending on the surface and bulk structure, Mie and Rayleigh scattering occur simultaneously. Scattering losses depend critically on the microstructure of the coatings and as such on the coating technology used. Usually, coatings produced by evaporation techniques show significantly higher scattering losses than coatings produced by magnetron sputtering or ion beam sputtering. The strong dependence of the scattering losses on the wavelength is the reason why scattering losses are a huge problem in the UV range while they are less important in the NIR and beyond.

Absorption in optical coatings and substrates is mainly determined by the band structure of the materials. Common oxide materials show band gaps of 3 to 7 eV which correspond to absorption edges in the NUV and DUV. Fluorides have band gaps of 9 to 10 eV resulting in absorption edges in the VUV spectral range (for more information please see page 138 ff). Some materials also show absorption bands in addition to the basic absorption edge as seen in the absorption band of Si-O-H bonds in Fused Silica around 2.7  $\mu\text{m}$ . Defects in the layers form absorbing states in the band gap of the materials. These defects may result from contaminations or from the formation of non-stoichiometric compounds. Optical coatings must be optimized with respect to low contamination levels and good stoichiometry. This kind of absorption losses also increases with decreasing wavelength.

The amount of all kinds of losses depends on the thickness of the layer system. Each layer pair increases the theoretical reflectance; however, in practice, it also increases the optical losses. There is an optimum number of layer pairs which generates the maximum reflectance, especially for evaporated coatings with relatively large scattering losses.

**Table 1:** Reflectance of HR mirrors in different spectral regions (for AOI = 0°)

Wavelength Range	Materials	Coating Technology	Reflectance
≈ 200 nm	fluorides	evaporation	> 98.0 %
≈ 250 nm	oxides	IAD sputtering	> 99.0 % > 99.7 %
≈ 300 nm	oxides	IAD sputtering	> 99.5 % > 99.9 %
≈ 350 nm	oxides	IAD sputtering	> 99.8 % > 99.95 %
VIS	oxides	IAD sputtering	> 99.9 % > 99.95 %
Low Loss Mirrors VIS	oxides	sputtering	> 99.99 %
NIR	oxides	IAD sputtering	> 99.9 % > 99.98 %
Low Loss Mirrors NIR	oxides	sputtering	> 99.998 %

## Stress

Another effect which limits the number of layers is the mechanical stress in the coating. This stress results from the structure of the layers but also from different thermal expansion coefficients of substrate and coating. Mechanical stress may deform the substrate, but it may also result in cracks in the coating or in a reduced adherence of the coating.

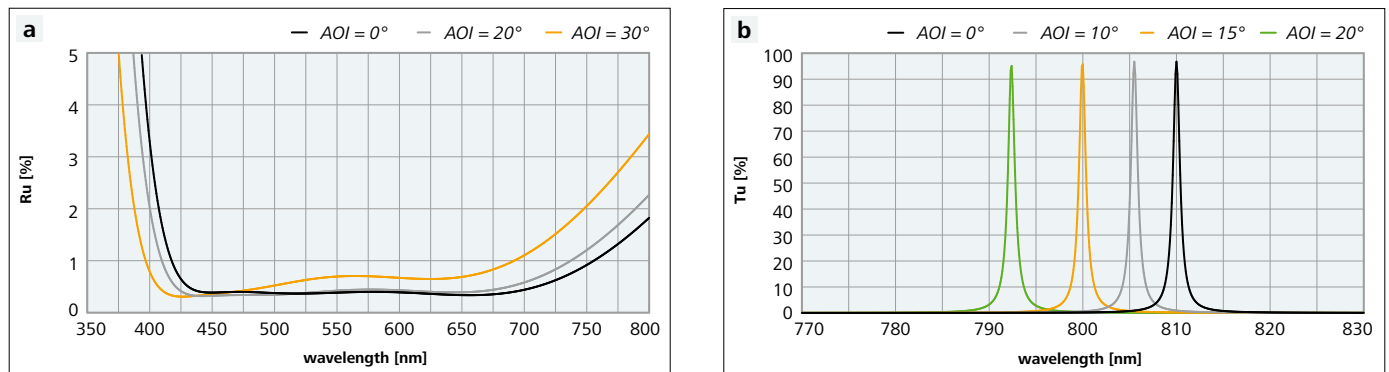
Stress can be limited by material selection and the optimization of process temperature, deposition rate and, in case of ion assisted and sputtering processes, ion energy and ion flux.

## Angle Shift

A special feature of interference coatings is the angle shift. It means that features shift to shorter wavelengths with increasing angle of incidence. Turning an optical component from  $AOI = 0^\circ$  to  $AOI = 45^\circ$  results in a downshift of the features by about 10 %. The angle of incidence must be known to design any optical coating. Moreover, polarization effects must be taken into account at non-normal incidence (see below).

Please note that the angle of incidence varies naturally if curved surfaces are used. Lenses in an optical system always have a range of acceptance angles which is determined by the shape of the lens and by the convergence or divergence of the beam. If these features are known, AR coatings can be improved significantly. Besides the shift, broadband AR coatings often show an increased reflectance at  $AOI \geq 30^\circ$  (see figure 6a).

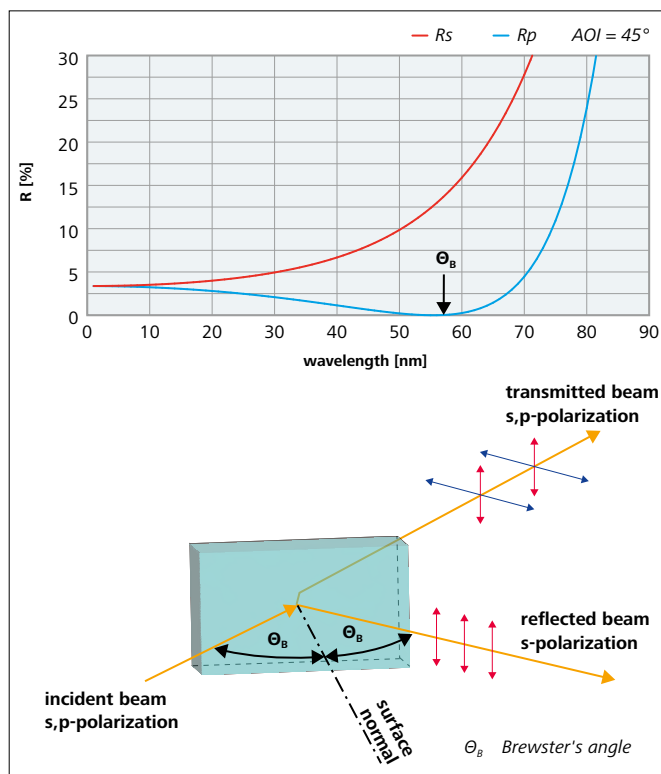
The angle shift offers the possibility of angle adjustment of an interference coating. This is especially useful in the case of filters and thin film polarizers. These optics show extremely narrow spectral ranges of optimum performance. It may decrease the output and increase the costs drastically if the specifications for wavelength and AOI are fixed. Angle adjustment (see figure 6b) is the best way to optimize performance and to minimize costs.



**Figure 6:** Change of optical properties at varying AOI  
**a)** Angle shift and change of reflectance of a broadband AR coating (unpolarized light)  
**b)** Angle tuning of a narrowband filter for 800 nm

## Polarization Effects

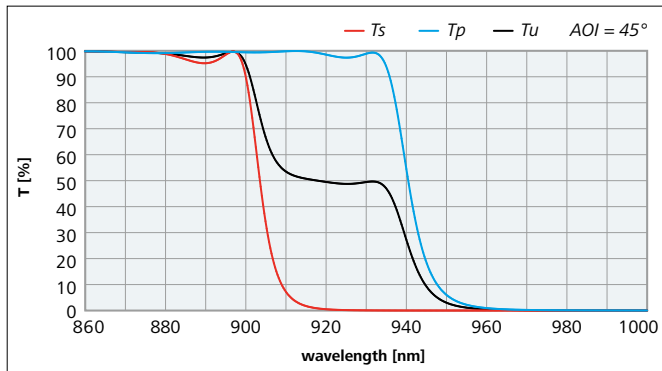
Besides angle shift, polarization effects appear at non-normal incidence. For optical interference coatings, it is sufficient to calculate the reflection coefficients for s- and p-polarized light. The reflectance of unpolarized light is calculated as the average of  $R_s$  and  $R_p$ .



**Figure 7:** Definition of the terms s-polarized light and p-polarized light and reflectance of an uncoated glass surface vs. angle of incidence for s- and p-polarized light

To explain the meaning of the terms s-polarization and p-polarization, a reference plane must be determined (see lower part of figure 7). This plane is defined by the incident beam and by the surface normal of the optic. "S-polarized light" is that part of the light which oscillates perpendicularly to this reference plane ("s" comes from the German word "senkrecht" = perpendicular). "P-polarized light" is the part which oscillates parallel to the reference plane. Light waves with a plane of oscillation inclined to these directions, are split into p-polarized and s-polarized parts.

The upper part of figure 7 shows the reflectance of a glass surface vs. AOI for s- and p-polarized light. The reflectance for s-polarized light increases with increasing angle of incidence. The reflectance for p-polarized light decreases initially, with  $R$  reaching 0 % at Brewster's angle and then increasing again as the angle of incidence extends beyond Brewster's angle. In principle, the same applies for dielectric mirrors. For  $AOI \neq 0^\circ$ , the reflectance for s-polarized light is higher and the reflection band is broader than for p-polarized light.



**Figure 8:** Polarization splitting of an edge filter. Please note that the edges of the reflectance bands are steep for s- as well as for p-polarization even at AOI = 45°, but they are located at different wavelengths. As a result, the edge of the reflectance band for unpolarized light is considerably broadened

In case of edge filters, where one of the edges of the reflectance band is used to separate wavelength regions of high reflectance and high transmittance, non-normal incidence results in a separation of the edges for s- and p-polarized light as the polarizations experience different angle shifts. Thus, for unpolarized light the edge is broadened considerably.

## Documentation of Coating Performance at LAYERTEC

LAYERTEC includes a data sheet of transmittance and/or reflectance for each delivered optical component. The standard procedure is to measure the transmittance of the optics at AOI = 0°. A mathematical refinement of the theoretical design to this measured spectrum is carried out and the reflectance at the desired AOI is calculated from this fit. Sputtered optical coatings for the VIS and NIR exhibit extremely low scattering and absorption losses (both in the order of some 10<sup>-5</sup>). This has been confirmed in direct measurements of scattering and absorption as well as via highly accurate reflectance measurements (e.g. by Cavity Ring-Down spectroscopy). The reflectance of sputtered mirrors can be approximated by measuring the transmittance T and using the simple formula

$$R = 100 \% - T$$

due to very small the optical losses. In a normal spectrophotometer, the transmittance can be measured with an accuracy of about 0.1 to 0.2 % (depending on the absolute value); whereas reflectance measurements in spectrophotometers mostly have errors of about 0.5 %. Thus, determining the reflectance of sputtered coatings in the VIS and NIR via transmittance measurements is much more accurate than direct reflectance measurements. Please note that this method can only be applied because the optical losses are very small (which is one of the advantages of sputtered coatings). The method is also used for evaporated coatings in the UV to NIR spectral range where the optical losses are only about 10<sup>-3</sup> and can be included into the reflectance calculation. In the DUV range, the coatings usually show scattering losses in the order of 10<sup>-3</sup> ... 10<sup>-2</sup>, depending on the wavelength. That is why, for example, fluoride coatings for wavelengths below 220 nm are delivered with direct reflectance measurements. Direct reflectance measurements are also necessary for low-loss mirrors. LAYERTEC has a Cavity Ring-Down set-up for spectrally resolved measurements in the wavelength range between 210 to 1800 nm.

**Figure 9:** Download measurement report form from the LAYERTEC website

The data sheets are available and can be downloaded from the LAYERTEC website. Figure 9 shows the download window for data sheets. To avoid mistakes, registration is required for batch number and part number.

# Metallic Coatings

Metals are the most common materials for mirror fabrication. Polished metals, especially gold, copper and bronze, were used as mirrors in the ancient world. In the middle-ages, mirrors with relatively constant reflectance in the visible spectral range were fabricated using tin foils and mercury which were put on glass. The era of thin film metal coatings on glass began in the 19<sup>th</sup> century when Justus von Liebig discovered that thin films of silver can be manufactured using silver nitrate and aldehyde. For applications in precision optics and laser physics, mirrors are produced by using the evaporation or the sputtering technique.

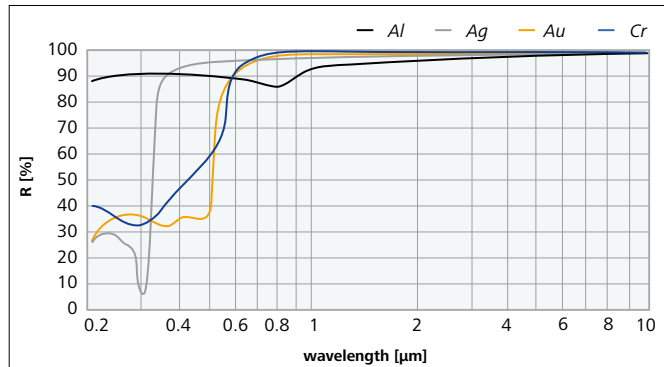


Figure 1: Reflectance of several metals versus wavelength (taken from Macleod [2])

LAYERTEC uses magnetron sputtering for manufacturing metallic coatings with extremely low scattering losses. Transparent, i.e. very thin, metal coatings can be produced with high accuracy. For detailed information about metallic mirrors and neutral density filters please see page 52 f. and 87 f. Figure 1 gives an overview about the reflectance of the most common metals. In the following, we give some advice about the use of these metals and the role of protective coatings.

## Silver

- Highest reflectance in the VIS and NIR
- LAYERTEC produces protective layers by magnetron sputtering. These layers with very high packing density make silver mirrors as stable as mirrors of other metals (e.g. aluminum). In normal atmosphere lifetimes of 10 years were demonstrated.
- The use of protective layers is mandatory. Unprotected silver is chemically unstable and soft
- Please see separate data sheets on page 52 f. and 87 f.

## Gold

- Similar reflectance as silver in the NIR
- Chemically stable, but soft
- Protective layers are necessary to allow cleaning of gold mirrors
- LAYERTEC recommends using protected silver mirrors instead of protected gold. The sputtered protective layers overcome the insufficiencies of silver. The broader wavelength range, the slightly higher reflectance and the favorable price also make silver the better option.
- See separate data sheet about gold mirrors on page 93 f.

## Aluminum

- Relatively high and constant reflectance in the VIS and NIR
- Highest reflectance in the UV
- Surface oxide layer absorbs in the deep UV
- A protective layer is recommended because aluminum is soft
- Please see separate data sheet on page 90 f.

## Chromium

- Medium reflectance in the VIS and NIR ( $R \approx 40\% - 80\%$  depending on the coating process)
- Hard (can be used without protective layer)
- Good adhesive layer for gold and other metals on glass substrates

## Protective Layers

- Enable cleaning of optics and improve chemical stability
- Influence the reflectance of the metal
- Even very thin sputtered layers can be used for chemical protection of the metal because of the high atomic density of the layers. Such layers show minimal influence on the VIS and NIR reflectance of the metal.
- Mechanical protection to enable cleaning of optics can only be achieved by relatively thick protective layer systems
- Optimization of the protective layer system for the wavelength of interest is particularly necessary in the UV



# Metal-Dielectric Coatings



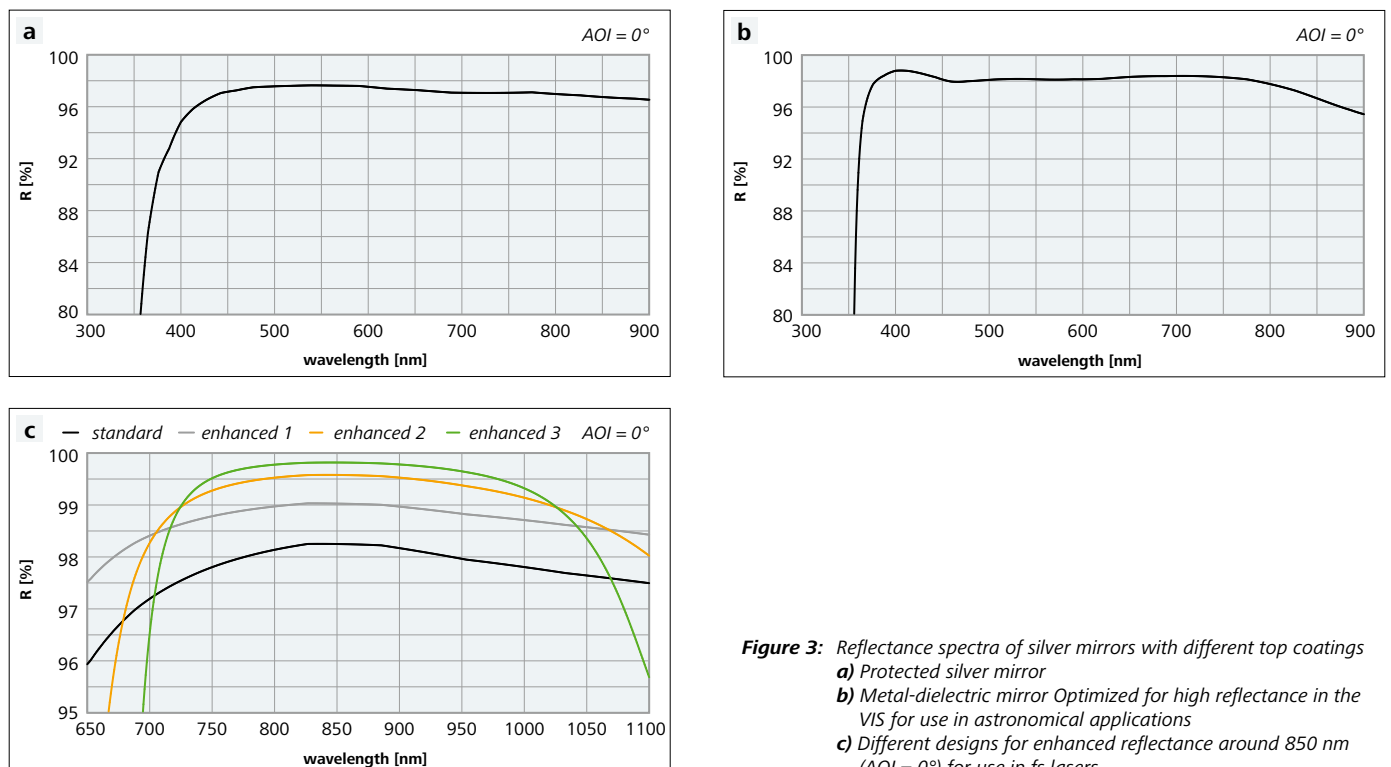
**Figure 1:** Off-axis parabola coated with a metal-dielectric silver mirror



**Figure 2:** Scanning mirrors with customized shape coated with a metal-dielectric silver mirror

In general, all layer systems consisting of metals and dielectric materials can be called “metal-dielectric coatings”. The most common ones are metal-dielectric filters consisting of transparent metal layers which are separated by a dielectric layer. These filters are characterized by extremely broad blocking ranges which result from reflectance and absorption of the metallic layers. The spectral position of the transmittance band is determined by the optical thickness of the dielectric spacer layer.

Moreover, metal-dielectric reflectors can be used for a variety of applications in optics and laser physics. Metals and metallic coatings show an extremely broadband natural reflectance which is restricted to about 90 % in the UV spectral range (aluminum), 96 % in the VIS (silver) and 99 % in the NIR (gold and silver). Most of the metals must be protected by dielectric coatings to overcome limitations of chemical (silver) or mechanical stability (aluminum, silver, gold). Almost all metallic mirrors are metal-dielectric coatings. The protective coatings always influence the reflectance of the metals. Single dielectric layers of any thickness lower the reflectance in most parts of the spectrum. Multilayer coatings on metals can increase the reflectance of the metallic coating. The bandwidth of enhanced reflectance can also be optimized for extremely broad spectral ranges as can be seen in figure 3. For more examples please see page 52 f., 76 f. and 87 ff.



**Figure 3:** Reflectance spectra of silver mirrors with different top coatings  
**a)** Protected silver mirror  
**b)** Metal-dielectric mirror Optimized for high reflectance in the VIS for use in astronomical applications  
**c)** Different designs for enhanced reflectance around 850 nm ( $AOI = 0^\circ$ ) for use in fs lasers

## Literature

- [1] P. W. Baumeister: “Optical coating technology”, SPIE press monograph, PM 137, Washington 2004
- [2] H. A. Macleod: “Thin film optical filters”, A. Hilger, Bristol, 1986
- [3] A. J. Thelen: “Design of optical interference coatings”, Mc Graw Hill, New York 1989
- [4] N. Kaiser, H. K. Pulker (eds.): “Optical interference coatings”, Springer Verlag Berlin Heidelberg, 2003

# Measurement Tools for Optical Coatings

## Spectral Photometry

Standard spectrophotometric measurements in the wavelength range  $\lambda = 190 \text{ nm}$  to  $3200 \text{ nm}$  are carried out with commercial spectrophotometers:

- PERKIN ELMER Lambda 1050<sup>®</sup>
- PERKIN ELMER Lambda 950<sup>®</sup>
- PERKIN ELMER Lambda 750<sup>®</sup>
- PERKIN ELMER Lambda 19<sup>®</sup>
- ANALYTIK JENA specord 250 plus<sup>®</sup>.

For measurements beyond this wavelength range, LAYERTEC is equipped with an FTIR spectrometer ( $\lambda = 1$  to  $20 \mu\text{m}$ ) and a VUV spectrophotometer ( $\lambda = 120$  to  $300 \text{ nm}$ ). Please note that the absolute accuracy of spectrophotometric measurement amounts to 0.2 to 0.4 % over the full scale measurement range  $R, T = 0$  to  $100 \%$ . For measurements with higher precision, a self-constructed set-up in the limited range  $T = 0.1$  to  $0.0001 \%$  with an accuracy up to 0.2 ppm is available.

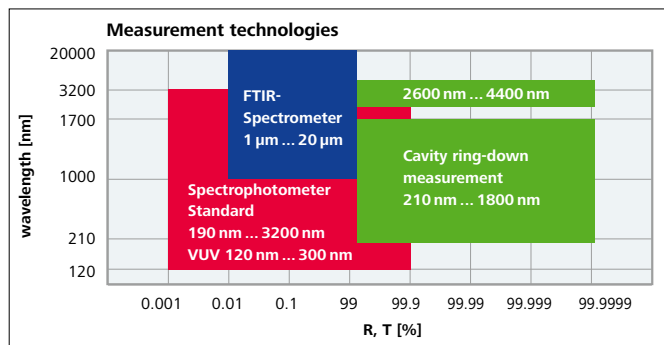


Figure 1: Measurement technologies and their range for reflectance and transmittance measurements at LAYERTEC

## Cavity Ring-Down Spectroscopy

High reflectance and transmittance values in the order of  $R, T = 99.5$  to  $99.9999 \%$  are determined by Cavity Ring-Down Time measurements. This method is an absolute measurement procedure with high accuracy, e.g.  $R = 99.995 \% \pm 0.001 \%$ . LAYERTEC operates various CRD systems which were developed in cooperation with research institutes and universities. A schematic representation of the CRD method is shown in figure 2.

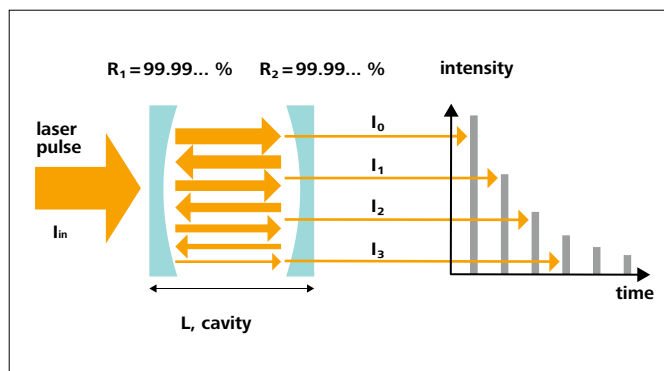


Figure 2: Schematic representation of the CRD method

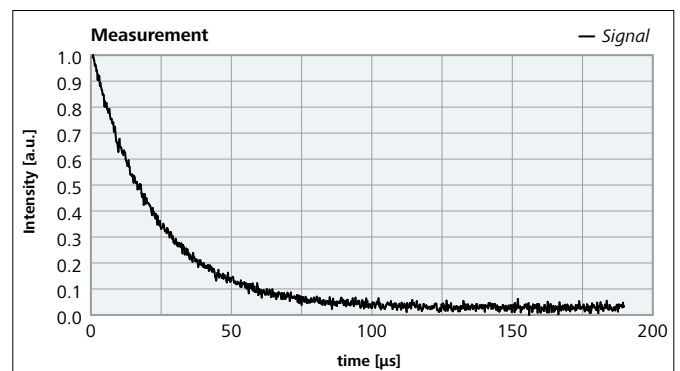


Figure 3: Exemplary mono-exponential CRD-curve of a highly reflecting mirror pair for 450 nm with  $R = 99.995 \%$  measured using a resonator length  $L = 228 \text{ mm}$

## Working Principle

A laser pulse is coupled into an optical cavity consisting of two highly reflecting mirrors. The intensity of the light is measured behind the cavity. At the beginning, the intensity increases during the pulse duration. Then it decreases exponentially with the time constant  $\tau$  according to

$$I_t = I_0 \exp\left(-\frac{t}{\tau}\right) \quad (1)$$

with:

$$\tau = \frac{L}{c(1 - RM)} \quad (2)$$

where  $c$  is the speed of light and  $L$  is the cavity length.  $RM$  is the geometric mean of the mirror reflectance and can be derived from the measurement of the time constant by

$$RM = \sqrt{R_1 R_2} = 1 - \frac{L}{c\tau} \quad (3)$$

The accuracy of the measurement depends on the accuracy of the time measurement and the measurement of the cavity length. Please note that errors of beam adjustment will always lower the decay time and/or will cause multi-exponential Ring-Down curves. In case of a single-exponential decay (figure 3), stochastic errors cannot result in overstated reflectance values. Compared to a reflectance measurement in a spectrophotometer, CRD has two main advantages:

- It is applicable for very high reflectance and transmittance values when using an enhanced measurement set-up.
- It is impossible to get measurement values which exceed the real ones.

The reflectance of single mirrors can be derived from pairs of measurements of a triplet of mirrors with  $R_1$ ,  $R_2$  and  $R_3$  being the reflectance values of the mirrors 1, 2 and 3, respectively, and  $RM_{12}$ ,  $RM_{23}$  and  $RM_{13}$  being the measured geometric means of the reflectance for the pairs of mirrors with the corresponding numbers. Three measurements of mirror pairs provide:

$$\begin{aligned} RM_{12} &= \sqrt{R_1 R_2} \\ RM_{23} &= \sqrt{R_2 R_3} \\ RM_{13} &= \sqrt{R_1 R_3} \end{aligned} \quad (4)$$

Solving this system of equations the mirror reflectance can be calculated by:

$$\begin{aligned} R_1 &= \frac{RM_{12} RM_{13}}{RM_{23}} \\ R_2 &= \frac{RM_{23} RM_{12}}{RM_{13}} \\ R_3 &= \frac{RM_{13} RM_{23}}{RM_{12}} \end{aligned} \quad (5)$$

In practice, this method is often used to determine the reflectance of a set of reference mirrors. Knowing the reflectance of a reference mirror, the reflectance of a specimen mirror can directly be derived using equation (3).

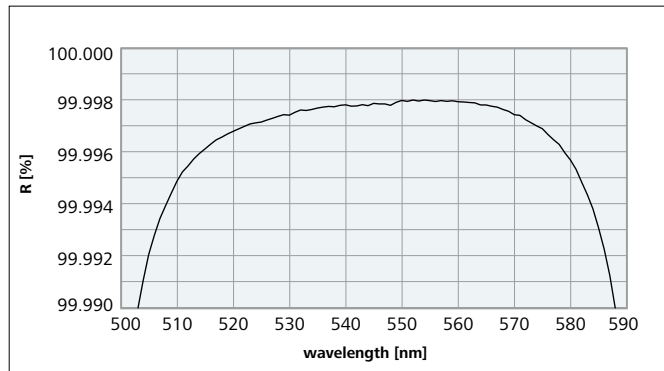


Figure 4: Spectrally resolved CRD measurement

## Broadband Cavity Ring-Down set-up and Applications

LAYERTEC has used CRD for the qualification of low loss mirrors for some years. Initially, there was the limitation that only discrete wavelengths, either generated by solid state lasers or diode lasers, could be used. The increasing demands concerning the optical properties of broadband mirrors required a measurement system for a spectral range over several hundreds of nanometers with a very high accuracy for measuring high reflectance values. So LAYERTEC developed a novel spectrally broadband Cavity Ring-Down time measurement system in cooperation with the Leibniz-Institute of Photonic Technology (IPHT) Jena e.V. [1]

[1] S. Schippel, P. Schmitz, P. Zimmermann, T. Bachmann, R. Eschner, C. Hülsen, B. Rudolph und H. Heyer: "Optische Beschichtungen mit geringsten Verlusten im UV-VIS-NIR-Bereich", Tagungsband Thüringer Grenz- und Oberflächentage und Thüringer Kolloquium "Dünne Schichten in der Optik", 7.– 9. September 2010, Gera; S. 268 – 282

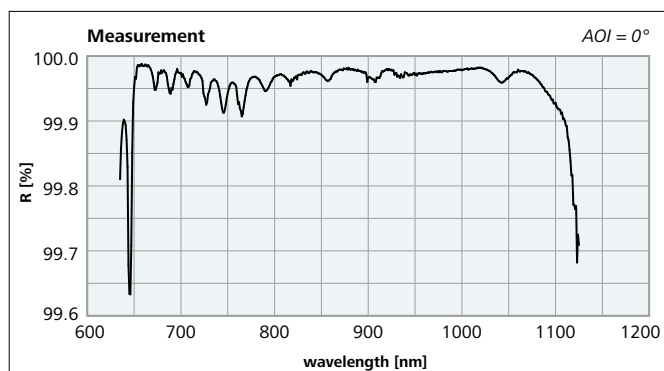


Figure 5: Reflectance spectrum of a negative dispersive broadband mirror for the wavelength region 650 – 1100 nm with  $R > 99.9\%$ . The measurement was performed by using an optical cavity consisting of 2 identical mirrors.

An optical parametric oscillator (OPO), pumped by the third harmonic of a Nd:YAG laser, is used as light source. The use of harmonic conversion extends the tuning range towards the UV region and provides a measurement range from 210 to 1800 nm without gaps. In this measurement set-up, photo multipliers and avalanche diodes are used as detectors. The Ring-Down cavity can consist of two or three cavity mirrors. A two mirror cavity is used for reflectance measurements at  $0^\circ$  angle of incidence (figure 5 shows an example of such a measurement).

In contrast, a three mirror cavity set-up is used for non-normal measurements with two mirrors mounted on precision rotary stages. This set-up can be used for wavelength scans at a constant angle or for angle resolved measurements at a constant wavelength (see figure 6). If the reflectance of two mirrors is known, the reflectance of the third mirror can be calculated. If the incidence of light is not perpendicular to the sample, the linear polarization of the OPO output beam can be rotated to set up perpendicular (s-) or parallel (p-) polarized light with respect to the sample over the entire spectral measurement range.

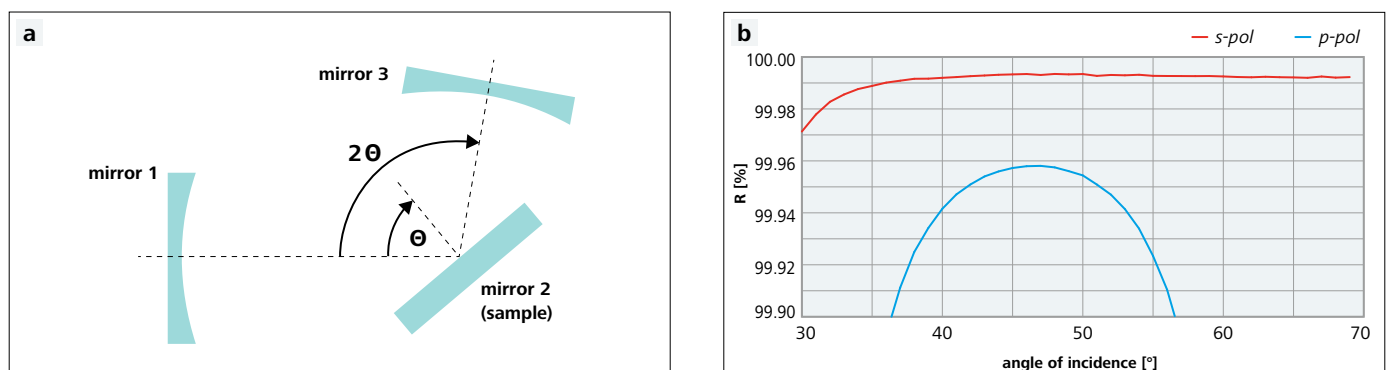


Figure 6: A V-shaped CRD cavity is used for the measurement. To analyze the polarization dependency of the mirror reflectance exactly, the measurement was performed at parallel (p-pol.) and perpendicular (s-pol.) polarization with respect to the sample (mirror 2).

a) Schematic representation of a three mirror cavity ("V-cavity")

b) CRD reflectance measurement of a turning mirror for 1064 nm with variable angle of incidence, but with fixed wavelength of 1064 nm.

A standard cavity is used for the measurement of very high transmission values  $T > 99.5\%$  and of optical losses of components or gases in the cavity. For transmittance measurements the sample is placed between the cavity mirrors. As the sample is an additional optical loss for the cavity, the transmittance value can be calculated if the reflectance of the cavity mirrors is known. For measurements at a defined angle of incidence, the sample can be tilted in the range of  $0^\circ - 75^\circ$  with respect to the optical axis of the cavity (figure 6b). Wavelength resolved measurements as well as angle resolved measurements are possible. The latter is very useful for the determination of the optimum angle for thin film polarizers (TFPs).

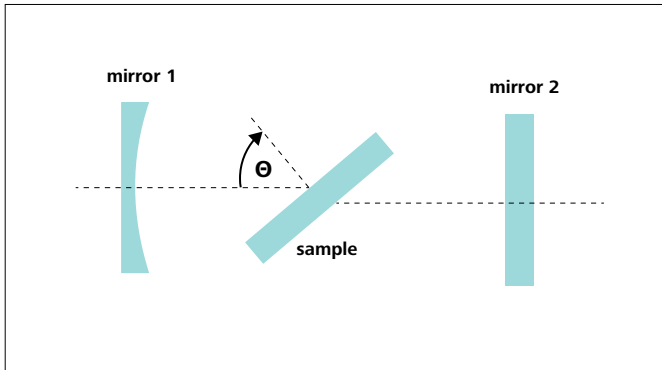


Figure 7: Schematic representation of a cavity for transmittance measurement

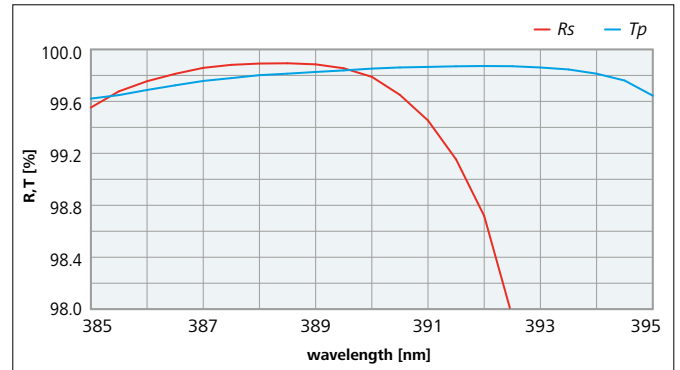


Figure 8: CRD measurement of a thin film polarizer for 390 nm: red curve –  $R_s$  (V-cavity), blue curve –  $T_p$  (two mirror cavity)

The same principle is used to determine optical losses of gases. First a spectrum of the evacuated cavity is measured. Then the cavity is filled with gas and the ring-down spectrum is measured again. The optical loss is calculated according to formula 6. As an example figure 9 shows the optical loss spectrum of ambient air.

$$V = \frac{L}{c} \left( \frac{1}{\tau_1} - \frac{1}{\tau_0} \right)$$

- $V$  = Optical loss between the cavity mirrors
  - $c$  = Speed of light
  - $L$  = Cavity length
  - $\tau_0$  = Decay time of evacuated cavity
  - $\tau_1$  = Decay time of cavity with sample between  $R_1$  and  $R_2$
- (6)

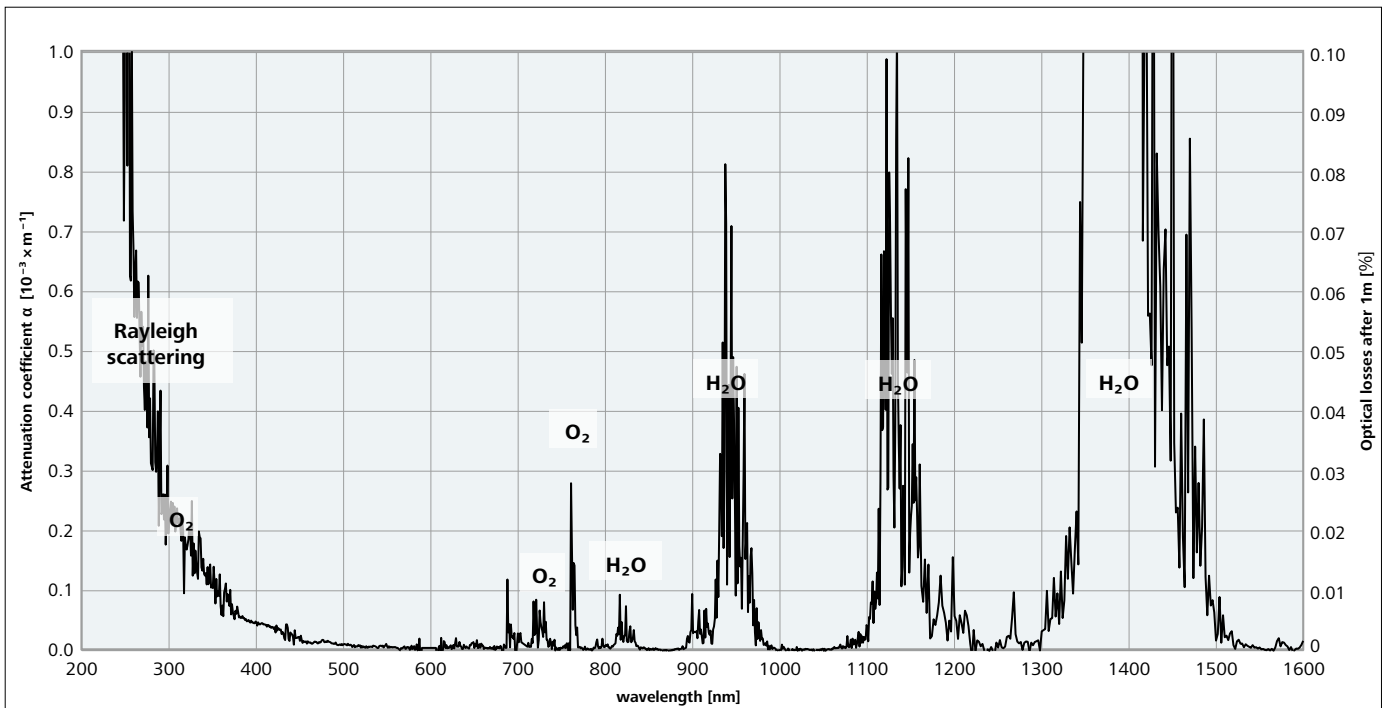


Figure 9: Measured optical loss spectrum of ambient air obtained with the LAYERTEC CRD set-up. For this measurement a total of 18 different pairs of CRD low loss mirrors were used

Measurement reports can be provided on request. The broadband set-up permanently undergoes further development. The measurement capabilities and the performance increase steadily.

## Laser-Induced Damage Threshold (LIDT)

LAYERTEC optics must be able to withstand extreme laser energies in some cases. In order to estimate the risk of possible damage to the coatings, the laser-induced damage threshold (LIDT) is determined.

Damage in optics for the continuous wave or short pulse regime (ns-range) is mainly related to thermal effects such as increased absorption – either due to the intrinsic absorption of the coating materials or absorption by defects – or poor thermal conductivity and low melting temperatures of the coatings. High power coatings require control of the intrinsic properties of the coating materials and the reduction of defects in the layers. Laser damage to picosecond and femto-second laser optics is mainly caused by field strength effects. Thus, high power coatings for these lasers require materials with large band gap and very special coating designs.

The determination of the laser-induced damage threshold (LIDT), according to the standards ISO 11254-1 (cw and 1-on-1, i.e. single pulse LIDT), ISO 11254-2 (S-on-1, i.e. multiple pulse LIDT) and ISO 11254-3 (LIDT for a certain number of pulses) requires laser systems operating under very stable conditions, precise beam diagnostics as well as online and offline damage detection systems. This is why a limited number of measurement systems with only a few types of lasers is available (e.g. for 1064 nm at Laser Zentrum Hannover). For some of the most prominent laser wavelengths, for example Argon ion lasers (488 nm or 514 nm), there is no measurement system available and certified LIDT data cannot be provided.

The 1-on-1 LIDT (i.e. 1 pulse on 1 site of the sample) is not representative for the normal operation conditions. However, these values can be used for comparing different coatings and for optimization procedures. The 1-on-1 values are directly related to the more practical S-on-1 LIDT (LIDT for a given number “S” of pulses on the same site of the sample). They can be interpreted as the upper limit of the LIDT. Laser systems with high repetition rates (some kHz) require lifetime tests expressed by LIDT values for high numbers of pulses.

### LIDT Measurement Set-up at LAYERTEC

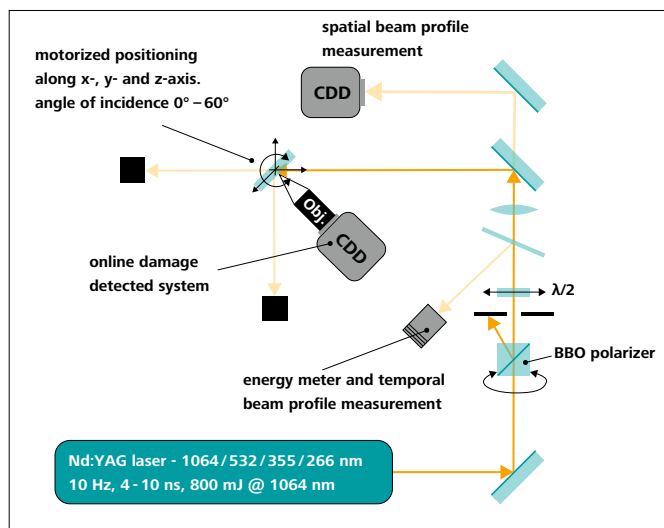


Figure 10: Nanosecond Nd:YAG laser LIDT measurement set-up at LAYERTEC.

LAYERTEC has developed its own LIDT measurement set-up for in-house measurements with the aim to optimize the coatings concerning their stability against laser damage. The light source is a Q-switched Nd:YAG laser which can emit wavelengths of 1064, 532, 355 and 266 nm. The pulse duration is about 4 to 10 ns and the repetition rate is 10 Hz at all four possible wavelengths. A close-to-Gaussian shaped beam profile is generated by focusing the laser beam with a lens. The spot size is in the region of 200 to 1000  $\mu\text{m}$  ( $1/e^2$  radius). The actual value depends on the wavelength and the focal length of the lens. The set-up satisfies the requirements of ISO 11254. It has an online detection system based on a digital camera with fast image processing to inspect the sample for damage after every laser pulse. Online beam profile measurements and the determination of the energy density are done with a CCD camera beam profiler in combination with calibrated energy measuring heads with single pulse resolution. A motorized 3-axis stage and a sample holder for multiple pieces allow automated measurements at angles of incidence in the range of  $0^\circ$  to  $60^\circ$  either on reflecting or transmitting samples. The linear polarization of the laser beam can be oriented for either p- or s-polarization with the help of wave plates and a broadband polarizer for the desired wavelength. The measurement set-up is shown schematically in figure 10.

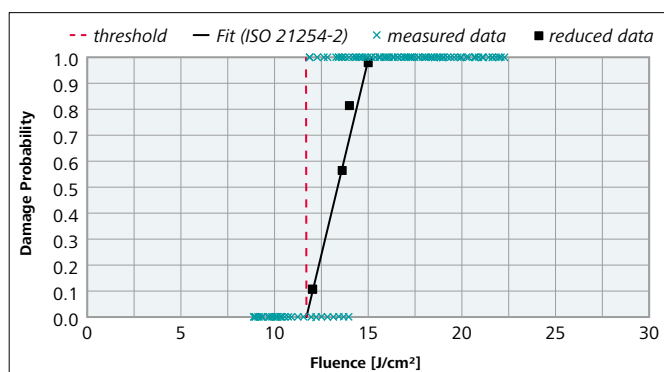


Figure 11: Damage probability of an antireflection coating for 355 nm after 1000 pulses (pulse duration 7 ns, 10 Hz repetition rate) according to ISO 11254-2. This measurement was performed at LAYERTEC.

LAYERTEC tests samples by using its own procedure (please see next section), because the ISO standards deliver unreliable values for damage thresholds above  $30 \text{ J/cm}^2$ . However, if a measurement according to ISO 11254-2 is explicitly requested, the ISO procedure will be used. In this case, 100 or 1000 pulses will be used at each measurement position in order to minimize measurement time. This is not a test for longtime stability. However, LIDT results for 100 or 1000 pulses are more realistic in comparison to 1-on-1 LIDT results. Figure 11 shows the result of a damage probability measurement according to ISO 11254-2.

The in-house LIDT measurements are mainly intended to compare LAYERTEC coatings among themselves for the purpose of coating and technology development. LAYERTEC provides LIDT results on request, but please note that these results are only valid for the specific measurement conditions (pulse duration, wavelength, number of pulses, beam shape, repetition rate).

## LAYERTEC LIDT Testing Procedure for Pulsed Laser Sources

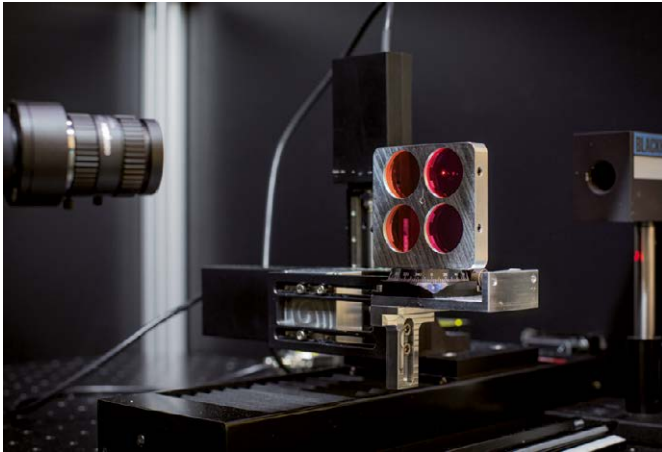


Figure 12: Sample stage of the LIDT measurement set-up

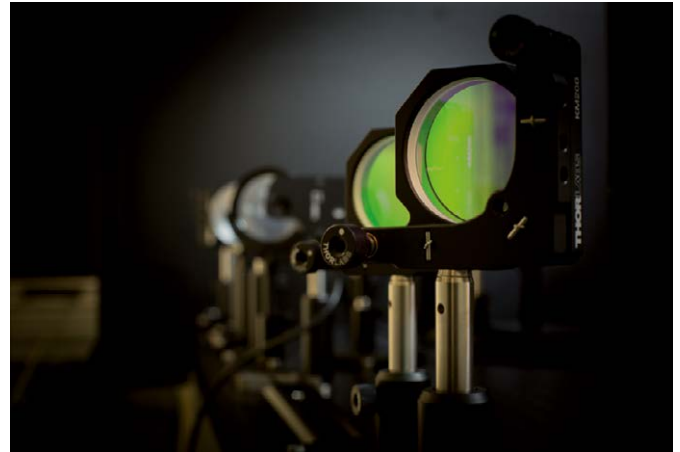


Figure 13: LIDT beamline

LAYERTEC has gained a lot of experience in laser damage testing by utilizing the LIDT testing procedures according to ISO 11254. However, it became clear that the measurements are both cost and time intensive but often deliver only questionable results. Significantly lower damage thresholds and strongly skewed damage probability distributions were observed in many cases. Troubleshooting the measurement set-up did not reveal any issues leaving only other reasons to explain the measurement errors.

As mentioned above, LAYERTEC uses a relatively large Gaussian-shaped laser spot to measure the damage threshold. The typical spot size is about 1 mm ( $1/e^2$  diameter). Large spot sizes require a high laser energy and peak power to reach the fluence necessary to cause destruction at the testing site. Coatings with damage thresholds above  $50 \text{ J/cm}^2$  require several hundreds of milli-joules laser pulse energy to show damage. In this case, large amounts of debris are generated and deposited within a circle of several millimeters in diameter around the damaged position. If an adjacent test site is located within this zone its damage threshold is significantly reduced due to the debris. This systematic error can be avoided by choosing a larger separation between the measurement positions while providing enough test sites. Very high damage thresholds above  $100 \text{ J/cm}^2$  require a separation between adjacent positions of more than 10 mm.

The ISO standard assumes a symmetric distribution for the damage probability. LAYERTEC observes this behavior only at average damage thresholds below  $30 \text{ J/cm}^2$ . Threshold probability distributions with average damage values above  $30 \text{ J/cm}^2$  are significantly skewed towards lower values. Assuming that the influence of debris can be neglected, the main reason for this phenomenon are imperfections in the coating and sometimes the surface quality itself. Contrary to ISO standards, significantly low threshold values should not be treated as statistical outliers. Strictly speaking, they have to be taken into account. Otherwise, damage threshold measurements would provide wrong values.

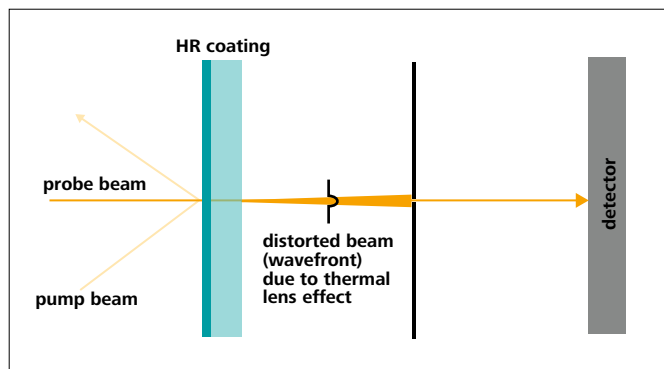
As discussed above, LIDT tests based on ISO standards are not viable for coatings with high damage thresholds. LAYERTEC developed an LIDT measurement method, which is well suited to measure the minimal damage threshold of optical coatings for high power or high energy laser applications. This procedure requires 4 to 7 testing positions with a separation of approximately 10 mm to each other on the sample. Wherever applicable, four identical samples with 25 mm in diameter are used to get 16 to 28 measuring positions per testing procedure. Every position is irradiated with stepwise increasing energy densities. The energy range of the test laser is subdivided into 50 levels. For the most part, 100 laser pulses are applied at each energy level to watch for cumulative effects in the coating. The starting energy has to be low enough to prevent any laser-induced damage. Then, the energy is increased until laser-induced damage occurs at the testing position.

All positions on the sample are irradiated in this way, until each position exhibits damage. For the purpose of measurement analysis, the highest, the average and the lowest measured damage threshold are reported. Further statistical analysis is not carried out. All damage threshold values measured by LAYERTEC, which are stated in this catalog, were determined according to the LAYERTEC LIDT testing procedure for pulsed laser sources. Additional measurements were performed by several partners, e.g. Laser Zentrum Hannover, Laser Labor Göttingen and Friedrich Schiller University Jena.

Due to the limited number of measurement facilities and the need for lifetime tests in practical applications, it is also necessary to include the measurements and lifetime tests (cumulative irradiation tests) of several customers into this catalog. Please take into account that these values cannot be compared with a standardized LIDT measurement because the laser parameters given are those without damage. Besides, these values always come with a measurement error, especially with respect to the determination of the spot size. Errors in the order of about 30 % must be taken into account. Information about parameters for long-time operation will certainly convince the customer to use LAYERTEC optics. Sometimes, however, these tests will be required in the customer's laser system. LAYERTEC supports such tests at the customer's facility with a considerable discount for test samples.

## Absorption Behavior

### Photo-thermal Common Path Interferometry (PCI)



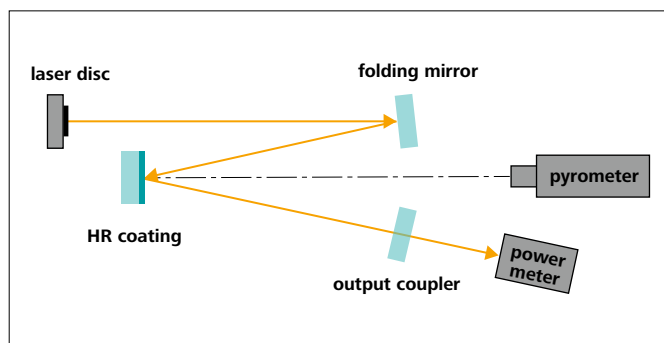
**Figure 14:** Schematic drawing of a photo-thermal common path interferometer (PCI)

A photo-thermal common path interferometer (PCI) allows LAYERTEC to determine the absorption of optical thin films and bulk materials. In this set-up, an optical surface is irradiated by a pump laser, resulting in the absorption of part of the infalling radiation, see figure 14. Due to thermal conduction, the absorbed energy is dispersed as heat within the optics, leading to the formation of a thermal lens.

A second laser, the probe beam, irradiates the thermal lens which deforms the wavefront of said probe beam. This deformation leads to interference effects within the probe beam and can be measured as intensity variations with a photodetector. The magnitude of the wavefront deformation is proportional to the amount of energy absorbed by the optics. The pump beam is switched on and off periodically, with a modulation frequency of several 100 Hz. Thus, the intensity of the probe interference-pattern is temporally modulated as well.

Pump beams at 355 nm, 532 nm or 1030 nm are available for s- and p-polarized light, measurement may be conducted for angles of incidence between 10° and 70°. However, a transmittance above 1 % for the wavelength of the probe beam, 635 nm, is required. Apart from that, any HR, PR or AR coating (including single layers) on most common substrates may be measured. Substrates have to be plane with a thickness of 1 – 12 mm. Calibration reports are available on request.

### Intra Cavity Heating Measurement (for coatings)



**Figure 15:** Intra cavity heating measurement set-up for HR-mirrors at 1030 nm

Absorption losses in optical coatings result in heating of coating and substrate. For average laser power levels above several kilowatts (cw), even low absorption losses in the range of some parts per million cause significant heating of the optical component. For example, the irradiated zone (1.5 mm in diameter) of an HR-coating with an absorption loss of 5 ppm at 1030 nm is heated to a temperature of about 80°C when exposed to a power of 80 kW.

LAYERTEC has built a heating measurement set-up for the purpose of quality assurance and technology development on high power optical components at a wavelength of 1030 nm. An Yb:YAG thin disc laser is used to generate a high power laser beam (figure 15). The set-up consists of a laser disc, a pump chamber, a sample (e.g. a highly reflective mirror) which works as a folding mirror, a second folding mirror, an output coupler, a laser power meter and a pyrometer for the temperature measurement. The beam spot size on the irradiated sample surface area is 1.5 mm ( $1/e^2$ ) in diameter. A very high intra cavity laser power of about 120 kW (cw) is achieved by choosing an output coupler with a relatively low transmittance value. Under these conditions, the power density on the sample is approximately 15 MW/cm<sup>2</sup>.

Generally, coatings with a set-up-specific operating temperature lower than 100°C can be used for high power applications. Please note that the average temperature of the optical component measured is clearly lower than the temperature within the small irradiated zone on the coating.

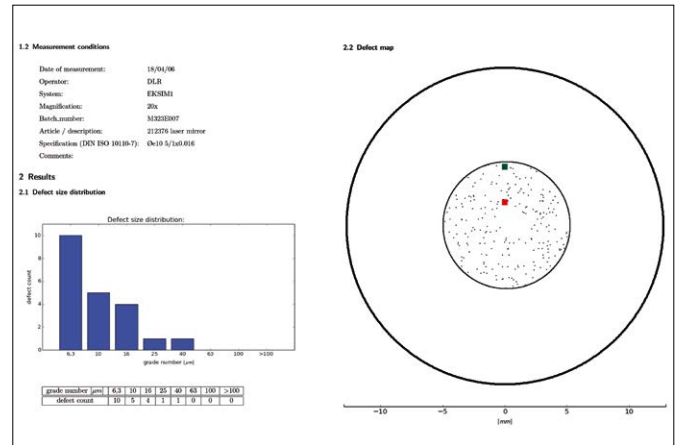
For the purpose of achieving absolute absorption measurements, it is possible to calibrate the set-up with a set of samples with well-known absorption. The absorption measurement of the calibration samples was performed by using the LID (laser-induced deflection) measurement set-up at the Leibniz-Institute of Photonic Technology (IPHT) Jena e.V..



Defect Inspection System for Coatings



**Figure 16:** Laser mirrors are placed in a special magazine holder for automated defect inspection at LAYERTEC.



**Figure 17:** Simplified inspection report of a laser mirror. The report shows the sizes and the coordinates of large defects on the coated surface. Furthermore, all defects which were found are shown in a histogram plot.

LAYERTEC built a measurement system capable of counting and classifying defects in optical coatings and on uncoated optical surfaces. The system detects down to 6 μm in size. It is able to inspect the complete surface of small as well as large optical components. Diameters  $\varnothing \leq 600$  mm and surface slopes up to 25° can be analyzed. Small to medium-sized pieces are placed in a special sample holder magazine which enables the automated measurement of a large number of pieces in a single inspection run (figure 16).

Measuring small defects is very challenging because the necessary microscope lenses have a very short depth of focus and require precise adjustment and positioning. Another important factor is proper lighting. Finally, the wide range of available geometries demands a very flexible control software, quickly adapting to new geometries in order to avoid collisions between the sample and the test system.

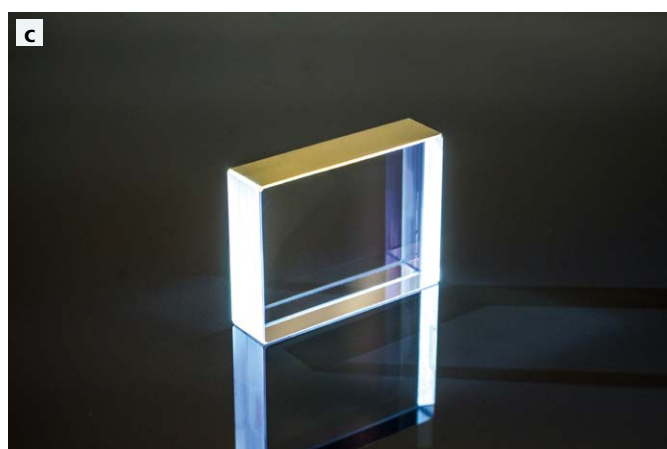
LAYERTEC constantly improves the system, enabling it to inspect cylindrical and aspherical optics while reducing effort and measurement time. Defects are classified by size according to ISO 10110-7 and their position on the optical surface is recorded. Thus, the complete set of microscopic imperfections on the optical surface can be visualized in a macroscopic defect map. Individual measurement reports, including defect maps and defect distributions, can be generated on request. An exemplary inspection report is shown in figure 17.

# Specials

## Chapter Index

Solderable Coatings .....	177
Lithography.....	178
Optical Assemblies .....	179
Laser Engraving.....	181

## Solderable Coatings



**Figure 1:** Examples for solderable optics

In the past years LAYERTEC has developed technologies to deposit solderable coatings, e.g. on the side edges, for custom parts as well as series components. Please note that due to the necessary masking of the optical functional surfaces, the simplest possible geometries and correspondingly large transition areas between metal and dielectric coating should be selected.

Such coatings are the prerequisite for bonding glass and metals, e.g. for mechanical support or targeted cooling.

# Lithography

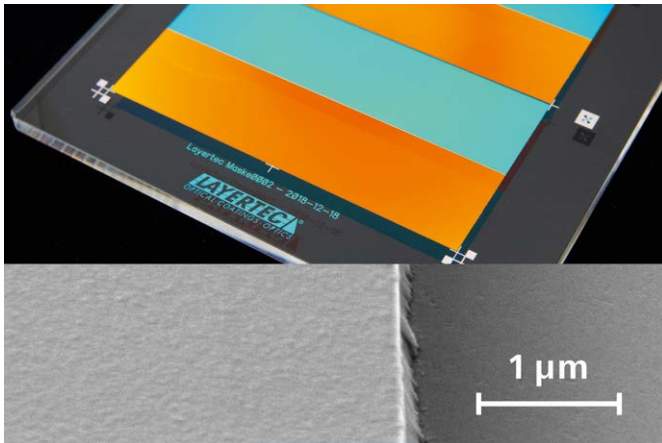


Figure 1: Lithographically structured coating

For special applications, it is necessary to coat only a partial area of an optical component or to combine different coating systems on the same surface. Essentially, all coating systems can be segmented. A large number of combination options is available (dielectric, metallic). The simplest option is coating with a mechanical mask/aperture, leaving the covered area of the surface uncoated.

However, the limits of this method are quickly reached for very small and geometrically complex structures. Since this method results in shielding effects in the covered area, structuring by means of photo lithography can be a useful alternative. For this purpose, a light-sensitive resist is exposed to UV-light on the component surface through a mask (to be prepared in advance). Depending on the type of photo resist, the exposed or unexposed area is then removed in a chemical process (positive/negative resist). Now the patterned plate is coated with the respective layer system over the entire surface, whereby the coating only has contact with the substrate in the defined area. Then the remaining photo resist with the coating on it is removed (lift-off process).

The etching process offers another possibility for structuring. In this process, the structure is etched out of the fully coated surface using appropriate etching solutions. This variant is particularly suitable for structuring metallic layers (Cr, Al, ...).

## Application Areas


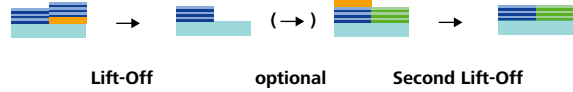
Segmented components can be used for lateral phase and/or amplitude modulation and are therefore suitable for example for mode selection or beam splitting. The structured components are designed for use in high power laser systems, the edges of the structures are laser-resistant up to the kW range.

## Production Possibilities

Fused Silica up to a size of currently 8 inches (plane) is used as the standard substrate material. On request, other materials are possible. Dielectric or metallic layers can be combined and applied in segments according to customer requirements. Depending on the layer design, structure sizes down to the micrometer range are possible.

## Working Principle

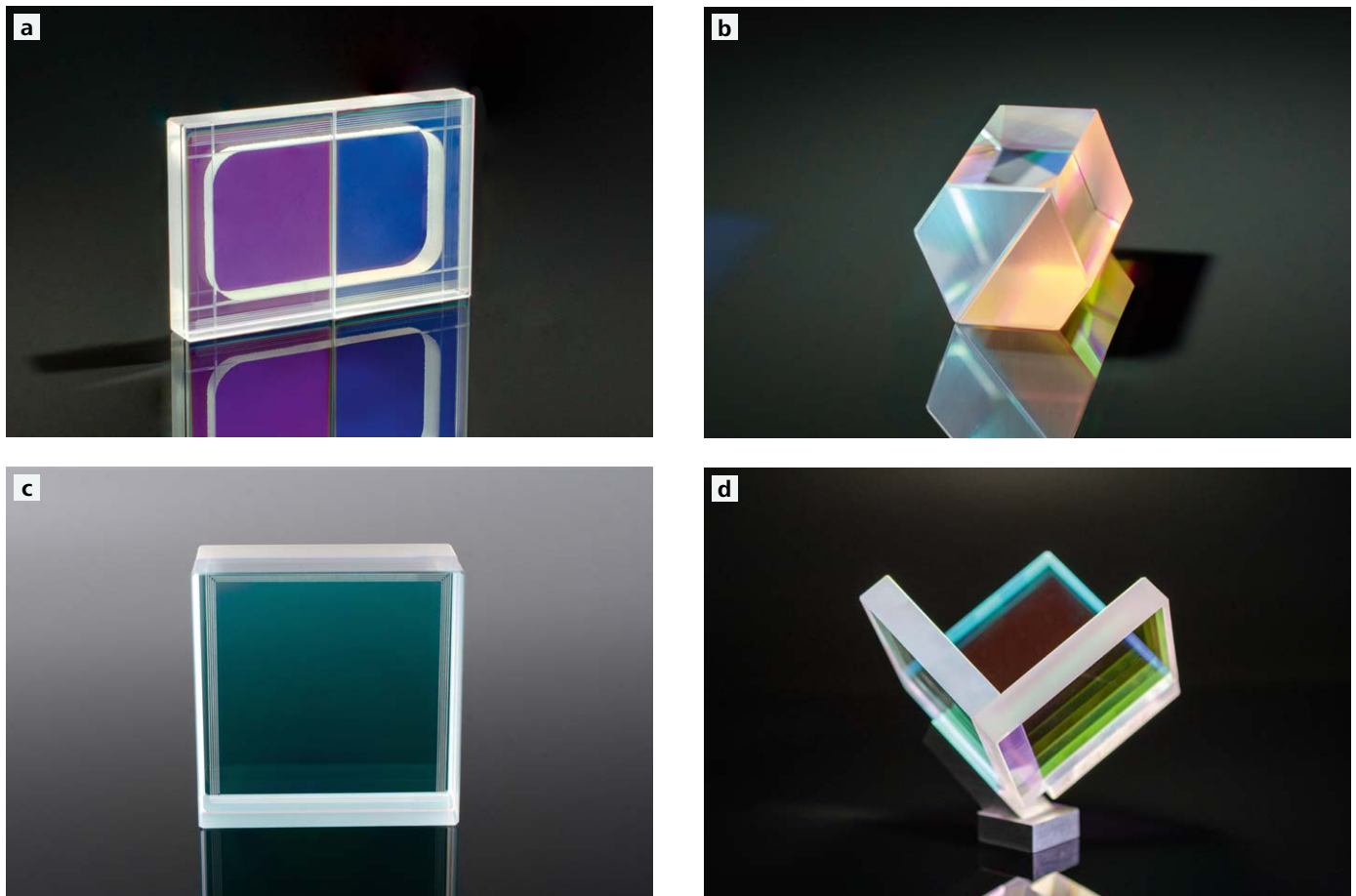
Table 1: Possible lithography procedures

Procedure	Etching	Lift-Off
Picture	 Etching	 Lift-Off      optional      Second Lift-Off
Coating material	Chromium, gold, aluminum, copper	dielectric, metallic, etc.
Structure size	> 5 µm, depending on the material and layer thickness	
Structure height	< 10 µm, depending on the material and structure size	
Substrate	Fused Silica, 50 – 200 mm in diameter	
Geometry	any, free cutting	
Final geometry	25 – 200 mm	
Thickness	down to 5 mm Ø > 10 mm 5 × 5 mm rectangular	

## Additional Options

- Multiple processing
- Lithography on both sides
- Ultrasonic Drilling
- Cut to size on wafer saw

## Optical Assemblies



**Figure 1:** Examples for optical assemblies  
**a)** Laser welded beam splitter  
**b)** Polarizing beam splitting prism  
**c)** Custom laser welded assembly  
**d)** Mounted hollow retro-reflector mirror

Optical assemblies provide complex functionality and performances, that might not be possible to achieve by single components. The integration of multiple components into higher-level assemblies unlocks features and special properties unable to achieve by monolithic elements, e.g. a broader spectral range of polarizing beam splitters or the integration of both mechanical and optical features.

LAYERTEC's in-house capabilities include the handling, positioning, alignment, and mounting of optical and opto-mechanical components, as well as multiple joining techniques to meet challenging customer demands. These joining techniques range from cost-effective and flexible to use adhesive bonding to organic-free optical contacting and bonding techniques suitable for high power and UV use. Our special bonding process as well as an ultrafast laser micro welding process are best suited for high precision assemblies with demanding alignment tolerances. They provide very high mechanical strength and long term stability even under challenging environmental conditions. Since both techniques result in intermediate layer free bonds they provide the lowest possible absorption and a high laser-induced damage threshold.

Building on long-lasting expertise, LAYERTEC can support the development and engineering of customer specific solutions from component and coating to the optical assembly. Our engineering support includes help in component design and substrate fabrication techniques, coating and material selection and the application of appropriate mounting and joining technologies according to your application requirements. LAYERTEC furthermore provides functional testing and optical metrology as well as mechanical and environmental testing to ensure performance specifications.

All the optics shown represent just a few manufacturing possibilities that have already been successfully realized. LAYERTEC's strength lies in finding individual solutions for complex problems.

## Custom Optics / Optical Assemblies

- Retro-reflecting hollow roof mirrors / hollow retro-reflectors
- Effective zero-order waveplates
- Beam Splitters
- Optical Cavities
- Customized mounted and unmounted laser optic assemblies

## Typical Specifications

- Dimensions 0.5" ...2" (others on request)
- Clear aperture > 90 %
- Surface imperfection tolerance: 5/ 1 x 0.016 L1 x 0.004
- Surface form tolerance:  $\lambda/4$  (others on request)
- Angular Accuracy: 5 arcsec (higher accuracy on request)
- Lateral Accuracy: 10  $\mu\text{m}$  (depending on geometry)

## Materials

- Fused Silica
- ULE®
- Crystalline Quartz
- Various optical glasses and crystals
- Metal mounts and holders

Most of LAYERTEC's specialized coatings can be applied to individual components prior to joining or to the optical assembly after joining. Please contact us to select appropriate coatings to satisfy your needs.

## Capabilities and Expertise

- Customized equipment for handling, adjustment, mounting, and joining
- Optical Alignment capabilities
- Support in engineering and production of prototypes to volume series
- CNC machining of opto-mechanical components
- Functional testing and optical metrology
- Mechanical and environmental testing

## Joining Technologies

- Adhesive bonding
- Optical contacting of highly planar glass surfaces
- Bonding of surface-activated polished surfaces
- Ultrafast laser micro welding

## Benefits

- High thermal, mechanical, and long-term stability
- Robust against thermal and environmental loads
- Organic-free bonds with ultra-low absorption
- High damage threshold, suitable for high power and UV use
- Suitable for vacuum use, fluidic/hermetical sealing
- Low wave front distortion
- High adjustment accuracy

# Laser Engraving

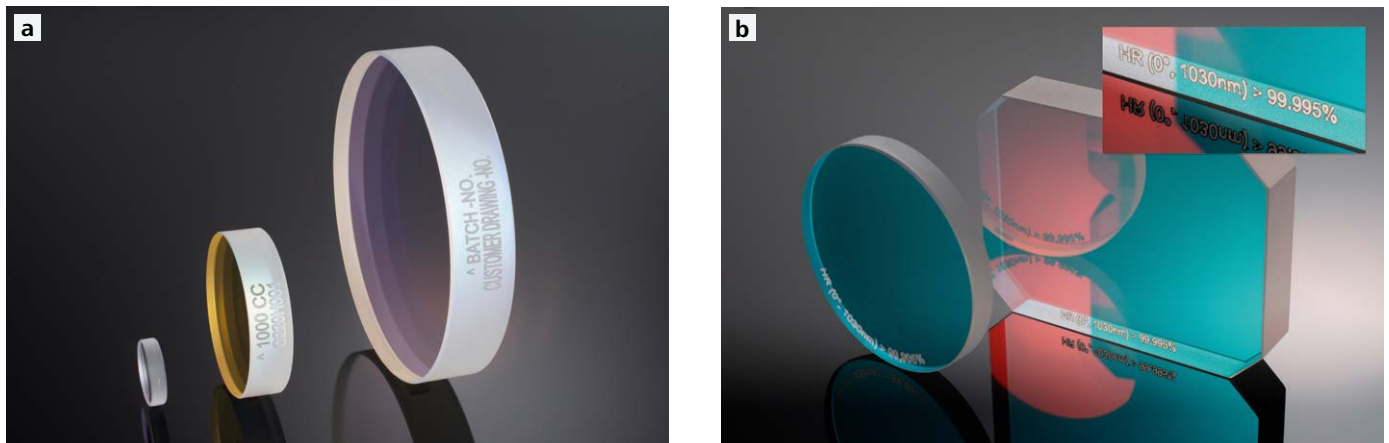


Figure 1: Examples for laser engravings

LAYERTEC uses laser engraving as a standard for all substrates and optics made of Fused Silica. It is possible to mark the edge as well as coated or uncoated functional surfaces.

The minimum character height is approximately 1.5 mm. The maximum substrate height when inserted is about 80 mm (including holder). Usually the optics are engraved lying on the side. The maximum lateral extension is 190 mm (with restrictions on height and location of engraving, see table below).

In direct contact with our sales department, please clarify for which materials and geometries such engraving is useful or necessary.

Table 1: Minimum requirements for laser engraving

Arrow Mark "Λ"	"Λ" and Batch Number	"Λ", Batch Number and Material Number/ROC
<p>Ø = 6 mm t = 2 mm</p>	<p>Ø = 10 mm t = 2 mm</p>	<p>Ø = 10 mm t = 5 mm</p>
<p>Engraving with a character (e.g. "Λ"):</p> <ul style="list-style-type: none"> <li>• t ≥ 2.0 mm</li> <li>• Ø ≥ 6.0 mm</li> </ul>	<p>Engraving with a character and batch number:</p> <ul style="list-style-type: none"> <li>• t ≥ 2.0 mm</li> <li>• Ø ≥ 10.0 mm</li> </ul>	<p>Engraving with a character, batch number and material number or ROC:</p> <ul style="list-style-type: none"> <li>• t ≥ 5.0 mm</li> <li>• Ø ≥ 10.0 mm</li> </ul>
<p>l = 3 mm t = 2 mm w = 3 mm</p>	<p>l = 7 mm t = 2 mm w = 3 mm</p>	<p>l = 7 mm t = 5 mm w = 3 mm</p>
<p>Engraving with a character (e.g. "Λ"):</p> <ul style="list-style-type: none"> <li>• t ≥ 2.0 mm</li> <li>• l ≥ 3.0 mm</li> </ul>	<p>Engraving with a character and batch number:</p> <ul style="list-style-type: none"> <li>• t ≥ 2.0 mm</li> <li>• l ≥ 7.0 mm</li> </ul>	<p>Engraving with a character, batch number and material number:</p> <ul style="list-style-type: none"> <li>• t ≥ 5.0 mm</li> <li>• l ≥ 7.0 mm</li> </ul>

# Knowhow

## Chapter Index

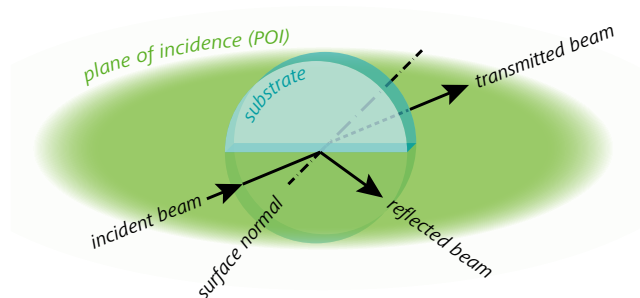
<b>Polarization .....</b>	<b>183</b>
<b>Dielectric Mirrors – Non-Normal Incidence.....</b>	<b>184</b>
<b>Weakly Curved Substrates.....</b>	<b>185</b>
<b>Surface Form Tolerances .....</b>	<b>186</b>
<b>Surface Imperfection Tolerances .....</b>	<b>187</b>
<b>Laser-Induced Damage Threshold (LIDT).....</b>	<b>188</b>
<b>Group Delay Distortion (GD &amp; GDD) .....</b>	<b>189</b>
<b>How to Mount Optics.....</b>	<b>190</b>
<b>Cleaning of Optical Surfaces .....</b>	<b>191</b>



# Polarization

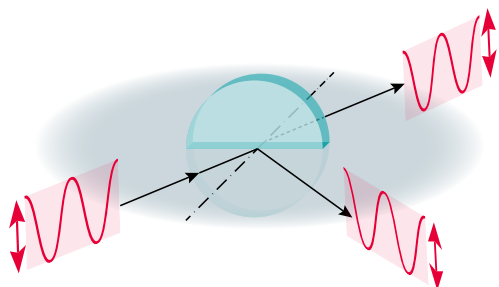
## Reflection on a Plane Surface

The plane of incidence (POI) is defined by the incident beam and the surface normal.



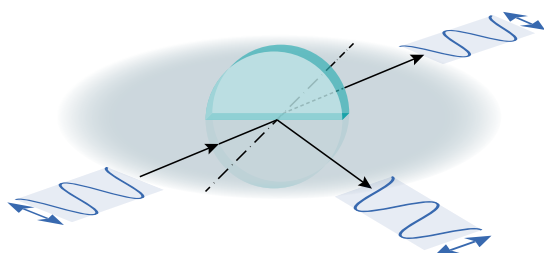
## s-Polarization

Electric field polarized perpendicular («senkrecht») to the POI, also known as  $\sigma$ - or TE (transverse-electric) polarization.



## p-Polarization

Electric field polarized parallel to the POI, also known as  $\pi$ - or TM (transverse-magnetic) polarization.

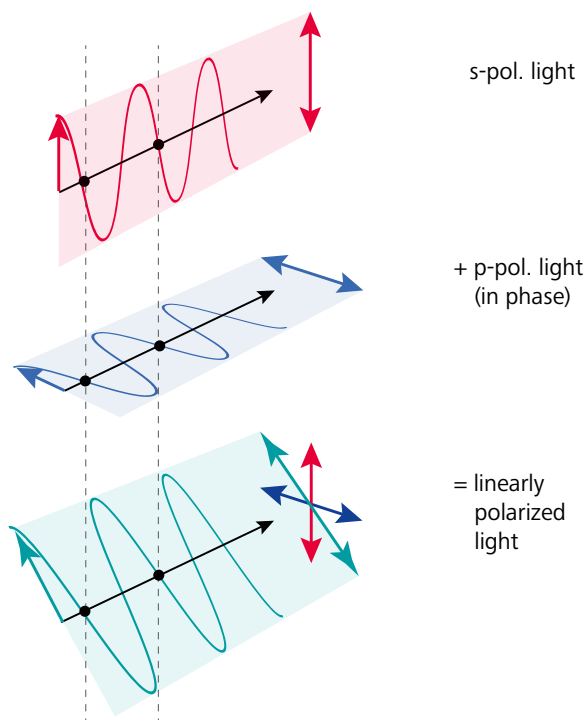


## Superposition of s- and p-Polarized Light

Any polarization state can be understood as a superposition of s- and p-polarized light.

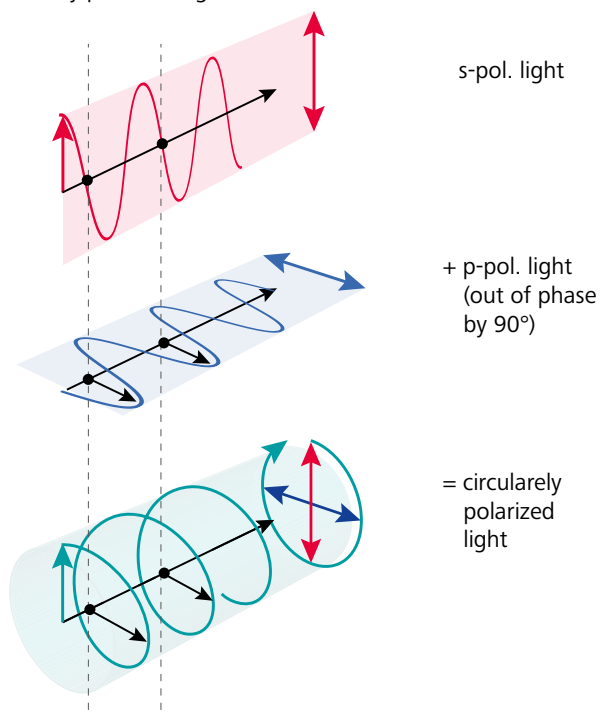
## Linearly Polarized Light

s- and p-polarized light without phase shift results in linearly polarized light.



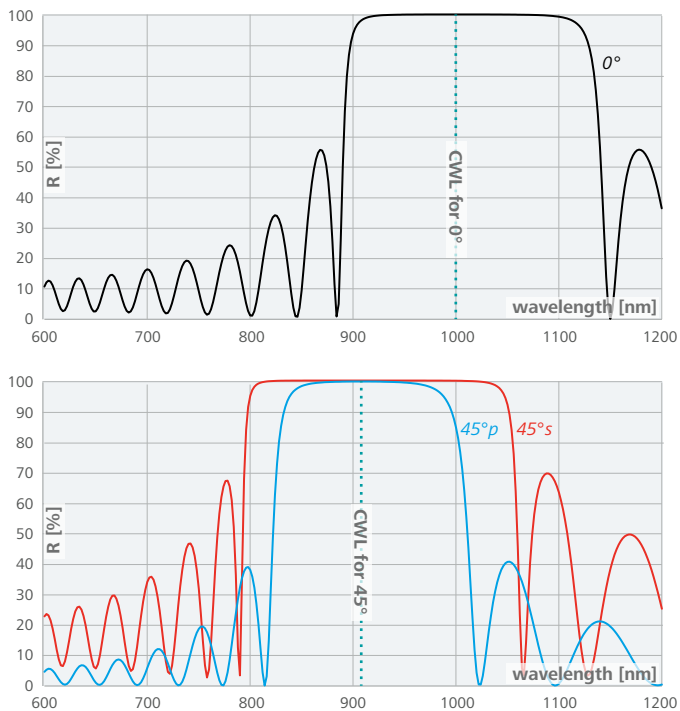
## Circularly Polarized Light

s- and p-polarized light with a phase shift of  $90^\circ$  results in circularly polarized light.



# Dielectric Mirrors – Non-Normal Incidence

## Center Wavelength (CWL) Shift with AOI

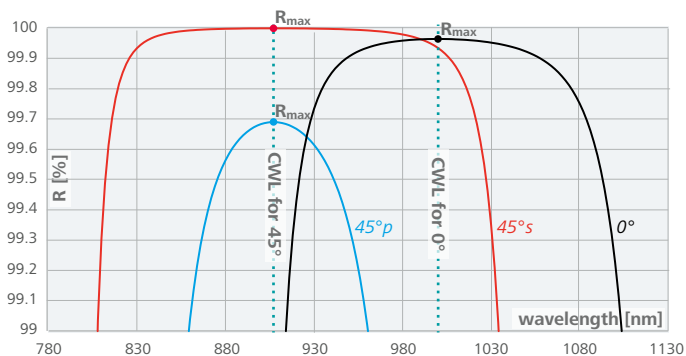


CWL s-pol. = CWL p-pol. for the same AOI

## Modification of Spectral Properties

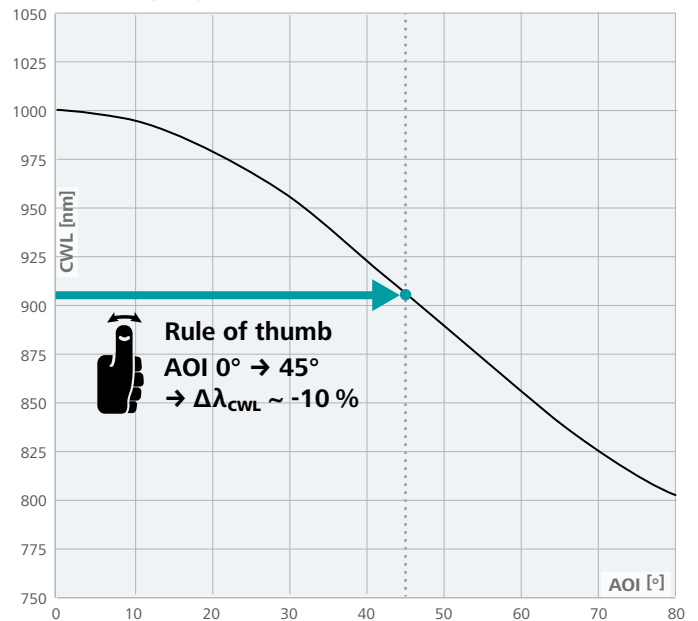
### Effects of increasing AOI

- HR-range shifts to shorter wavelengths
- Wider HR<sub>s</sub>-range
- Narrower HR<sub>p</sub>-range
- Increasing R<sub>s</sub> at the CWL
- Decreasing R<sub>p</sub> at the CWL



## CWL Shift with AOI

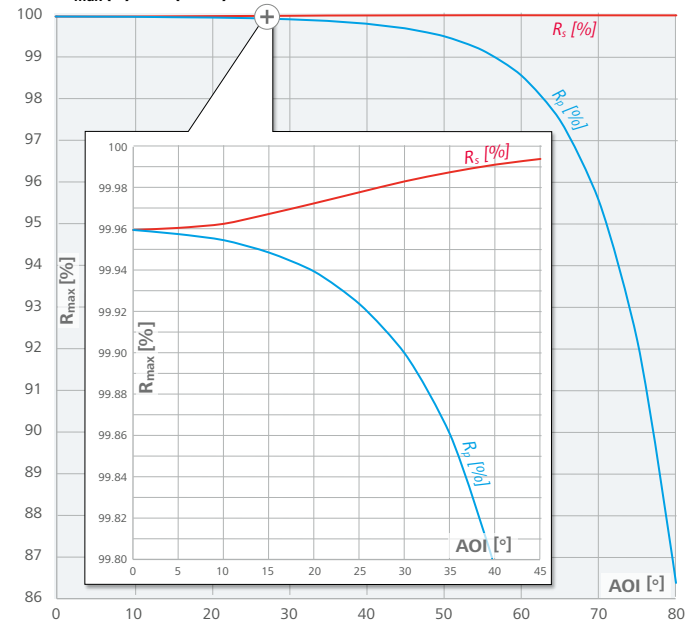
$$\text{CWL} = f(\text{AOI})$$



Please note that the plots shown here are numerical results. The actual values may change if different methods are used. However, the overall behavior, including the rule of thumb, remains the same.

## Split-Up of s- and p-Polarization

$$R_{\text{max}}(\lambda) = f(\text{AOI})$$

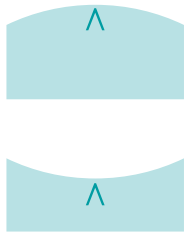
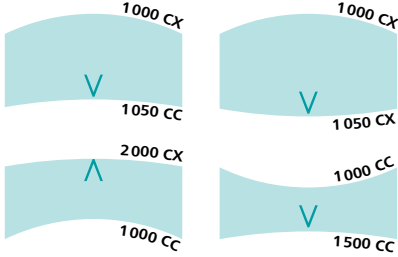
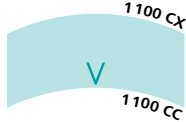


# Weakly Curved Substrates

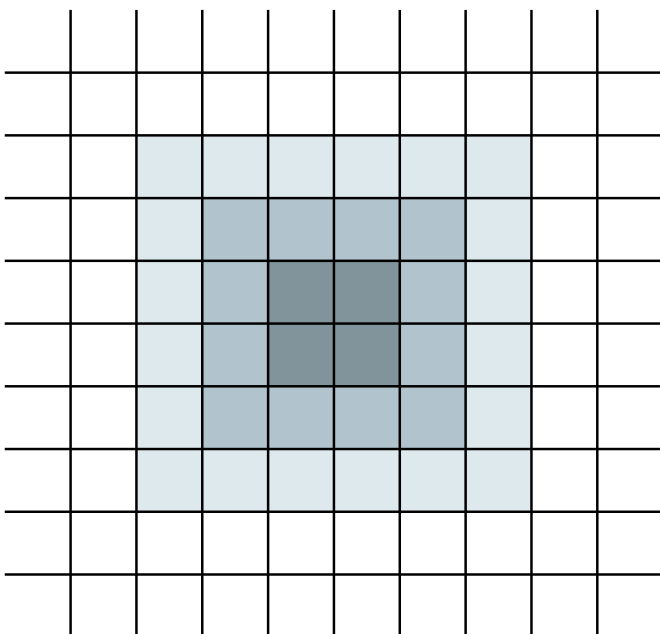
## LAYERTEC Convention

LAYERTEC applies a marker to the outer cylinder of weakly curved substrates. This allows a reliable identification of both sides. As shown below, the marker points to either the curved, the weaker curved or the concave surface (depending on the general shape of the substrate). It is only applied for radii of curvature  $R > 1000$  mm.

## LAYERTEC marker conventions of weakly curved substrates

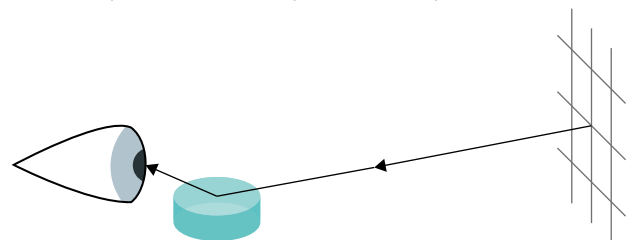
Substrates with a plane and a spherical surface	Substrates with two spherical surfaces	Substrates with two parallel spherical surfaces (Meniscus Lenses)
<p>Marker points to the curved surface</p> 	<p>Marker points to the surface with the larger radius of curvature (i.e. the weaker curvature)</p> 	<p>Marker points to the concave surface</p> 

## Visual Identification



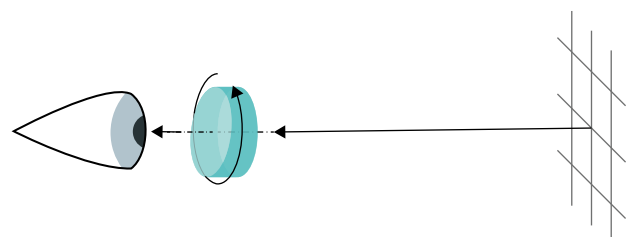
## Finding the Plane Side

- Hold optical element close to your eye.
- Watch the reflection of the pattern in the optical surface (focusing to a long distance).
- Reflected pattern is blurred → curved side is up
- Reflected pattern is clear → plane side is up



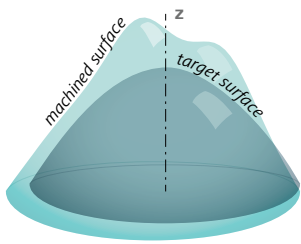
## Is the Substrate Wedged?

- Watch pattern through optical element.
- Rotate optical element around surface normal.
- Pattern shifts with respect to surrounding area → optical element is wedged
- No shift → no wedge is present



# Surface Form Tolerances

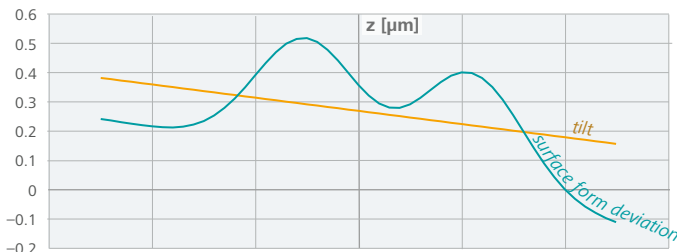
## Target Surface vs. Machined Surface



Machined surface  
- target surface  
= surface form deviation

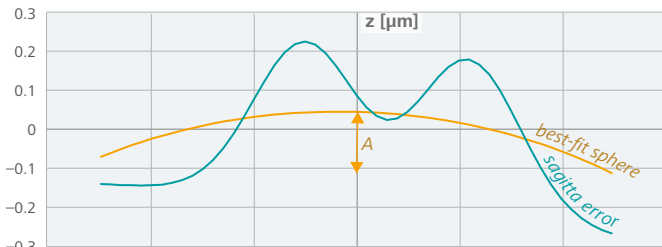
## Surface Form Parameters

### Surface form deviation



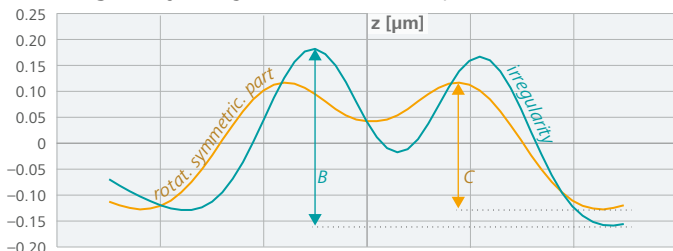
$D_t$  = RMS (sagitta error);  $A$  = PV (best-fit sphere)

### Sagitta error = surface form deviation – tilt (best linear rms fit)



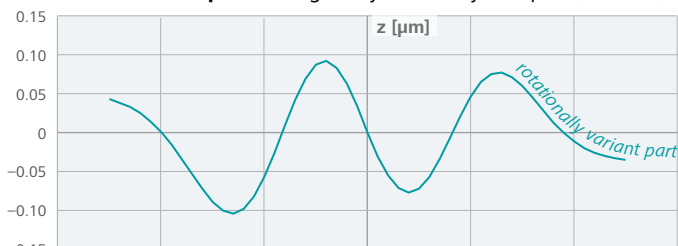
$D_t$  = RMS (sagitta error);  $A$  = PV (best-fit sphere)

### Irregularity = Sagitta error – best-fit sphere (rms crit.)



$D_i$  = RMS (irregularity);  $B$  = PV (irregularity);  $C$  = PV (rotat. symm. part)

### Rotat. variant part = irregularity – rotat. symm. part (rms crit.)



$D_a$  = RMS (rotationally variant part)

Only sectional views of the 3D optical surface are shown above.

## Syntax

**3/ A(B/C) RMSt < Dt; RMSi < Di; RMSa < Da; λ = E**

- A** = Sagitta error  $\Delta$  PV of best-fit sphere; [nm] or [fringes]
- B** = PV of irregularity; [nm] or [fringes]
- C** = PV of rotationally invariant irregularity; [nm] or [fringes]
- Dt** = RMS of sagitta error; [nm] or [fringes]
- Di** = RMS of irregularity; [nm] or [fringes]
- Da** = RMS of rotationally variant irregularity; [nm] or [fringes]
- E** = Reference wavelength for fringe spacing; [nm]

## Syntax Example

Example	Meaning
3/ -(1); RMSa < 0.1	B = 1 fringe = $1 \times \lambda / 2 = 0.5 \times 546 \text{ nm}$ = 273 nm; Da < 0.1 fringe
3/ 2(1/0.5); λ = 632.8 nm	A = 2 fringe; B = 1 fringe; C = 0.5 fringe; 1 fringe = $0.5 \times 632.8 \text{ nm} = 316.4 \text{ nm}$
3/ -; RMSt < 100 nm; RMSi < 30 nm	Dt < 100 nm; Di < 30 nm

## Fringes to λ

Fringes	λ	λ = 546 nm
1 fringe	λ/2	273 nm
0.5 fringe	λ/4	136.5 nm
0.2 fringe	λ/10	54.6 nm
0.1 fringe	λ/20	27.3 nm
0.04 fringe	λ/50	10.92 nm

## Basic Rules

If tolerances are specified without a unit they are given in fringes. According to ISO 10110-5:2016-04 the reference wavelength always has to be specified.

Please note that in older versions of the standard  $\lambda = 546 \text{ nm}$  (Hg e-line) is assumed if no reference wavelength is specified.

## How flat is flat?

A flatness of  $\lambda/10$  on a substrate 6" in diameter is equal to



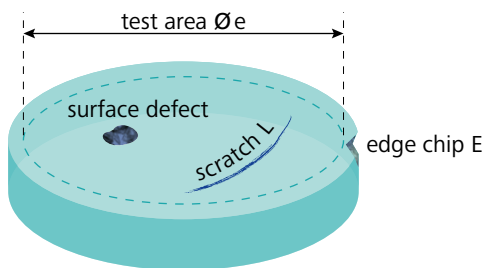
the size of a football on Germany.

# Surface Imperfection Tolerances

## Syntax

**5/ N×B; CN×B; LN×F; ED**

- A** = Defect area [mm<sup>2</sup>]
- B** =  $\sqrt{A}$  (grade number) [mm]
- D** = Length of edge chips [mm]
- F** = Width of a scratch [mm]
- N** = Number of imperfections
- C** = Coating
- E** = Edge chips
- L** = Scratch



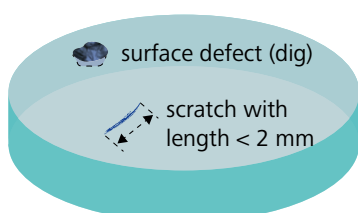
Syntax	Meaning	Example
5/ N×B	Imperfections of the final surface (uncoated or coated)	5/ 2×0.01
5/ N×B; C N×B	All imperfections of the surface; Imperfections of the coating only	5/ 4×0.025; C 2×0.063
5/ L N×F	Additional scratches (length > 2 mm)	5/ L 3×0.1
5/ E D	Additional edge chips	5/ E 1.0

Surface imperfections in this catalog are specified for coated substrates. For more information regarding specification of surface imperfections, especially long scratches and edge chips, please see »LAYERTEC's Guide to Optical Coatings and Optics.«

## Digs and Scratches < 2 mm

**5/ N×B**

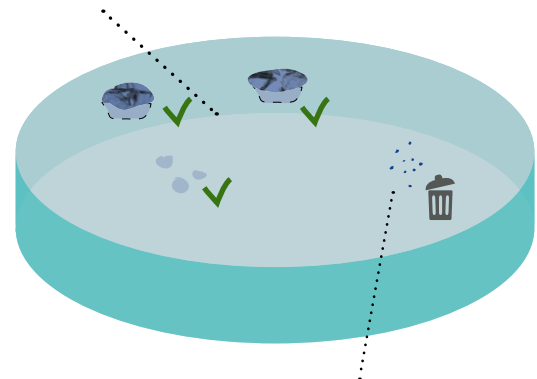
- N** = Number of imperfections (digs, scratches with length < 2 mm, local substrate imperfections)
- B** = Grade number =  $\sqrt{A}$  [mm]; A: defect area [mm<sup>2</sup>]  
Preferred values for laser optics (not specified by ISO 10110):  
**B = 0.16, 0.1, 0.063, 0.04, 0.025, 0.016, 0.01**



## Example

**5/ 3×0.063**

Maximum of 3 imperfections on the surface with a maximum area  $A \leq 0.063 \times 0.063$  mm<sup>2</sup> each. Each permissible defect may be replaced by smaller ones with  $A_{total} = A_1 + A_2 + A_3 + \dots$  as long as the total area does not exceed  $N \times B^2$  mm<sup>2</sup> (here:  $3 \times 0.063^2$  mm<sup>2</sup>).



Not considered are defects with areas equal to or smaller than  $A = (0.16 \times 0.063)^2$  mm<sup>2</sup>.

Defects may be replaced by smaller ones as long as the specified total defect area is not exceeded:  $A_{total} = \sum_i A_i < N \times B^2$ . Defects with grade numbers equal to or smaller than  $0.16 \times B$  are not considered.

## Why to use ISO 10110 rather than MIL

**MIL: s/d 20-5**

- max. scratch width < 0.02 mm
- max. dig size < 0.05 mm
- Only dimensions are specified, not numbers of digs/scratches.

With regard to the MIL standard there is »confusion regarding physical sizes of scratches and digs of a given number.« Especially, there is »no consensus interpretation among U.S. optics vendors for the scratch spec.«

**ISO 10110: 5/ 3×0.05 L 1×0.02**

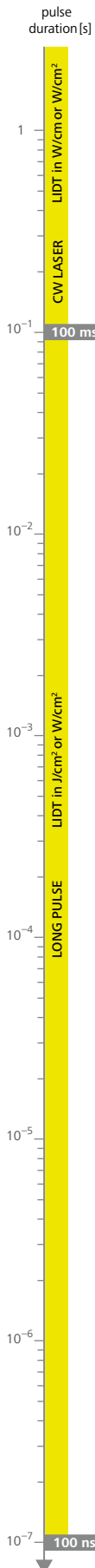
- no more than 3 digs with max. size < 0.05 mm
- no more than 1 scratch with max. width < 0.02 mm (scratches with a length below 2 mm are considered as digs)
- In contrast, ISO 10110 also includes the maximum number of permissible surface imperfections.

»ISO 10110 is intuitive and easy to understand (regarding) inclusions« as well as »clear and unambiguous (with respect to) surface imperfections«.

Wang et al.; Implementation of ISO 10110 optics drawing standards for the national ignition facility; SPIE, 3782:502-508; 1999

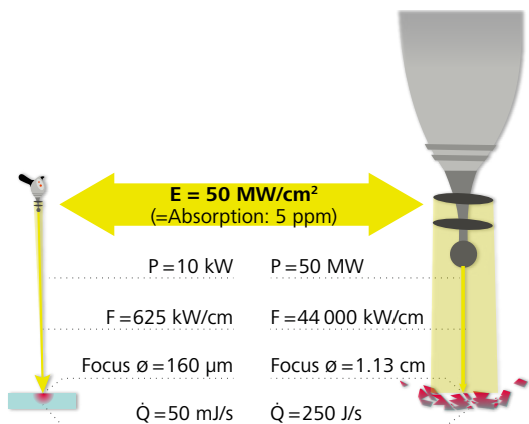
# Laser-Induced Damage Threshold (LIDT)

## Long Pulse and cw-Lasers



- Long pulse with high average power**
- Absorption because of impurities, structural defects and intrinsic material properties:
    - Local heating
    - **Thermal destruction**
  - LIDT is determined by melting point, heat transfer, purity of the coating

$LIDT_{cw} [kW/cm^2] \sim 10 LIDT_{long\ pulse} [J/cm^2]$



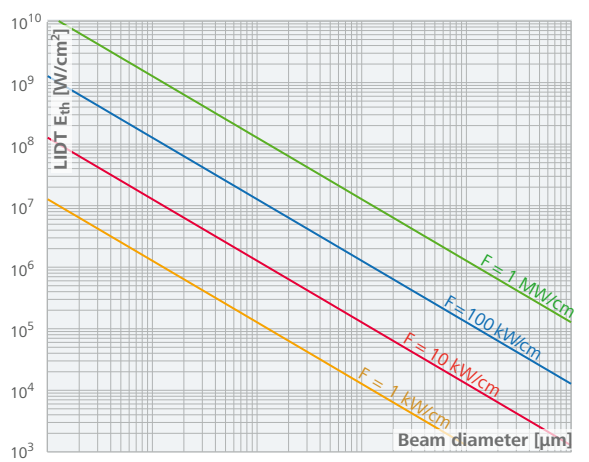
Sufficient heat transport within the substrate – component withstands the laser beam.

Heat buildup caused by insufficient heat transport – component is thermally destroyed.

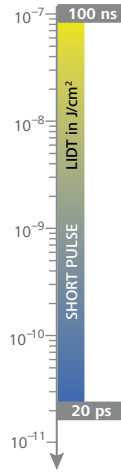
$$F = \frac{\text{beam power}}{\text{beam diameter}} = \frac{P}{d_{\text{eff}}}$$

$$d_{\text{eff}} = 2 \sqrt{\frac{P}{\pi E_{\text{max}}}}$$

$d_{\text{eff}}$  = Effective beam diameter [cm]  
 $E_{\text{max}}$  = Maximal power density [W/cm²]



## Short Pulses – Pulse Length Scaling



Scaling of LIDT test data to another pulse duration may result in an error of up to 25 %.

$LIDT \propto \sqrt{\tau} \rightarrow LIDT_1 \approx LIDT_0 \sqrt{\frac{\tau_1}{\tau_0}}$

$20\text{ ps} \leq \tau \leq 100\text{ ns}$        $\tau$  = Pulse duration

Ref.: Stuart, B.C., et al.; Laser-induced damage in dielectrics with nano-second to subpicosecond pulses; Phys. Rev. Lett., 74, 2248-2251; 1995

## Ultra-Short Pulses – Temporal Pulse Shape



- Short pulse with high peak pulse power**
- Absorption because of transfer of electrons from valence band to conduction band:
    - Ionization
    - **Electronic destruction**
  - LIDT is determined mostly by band gap, i.e. material properties

**Towards shorter pulses intensity becomes the crucial quantity for LIDT.**

**Intensity [W/cm²]:**

**Fluence [J/cm²]:**

$$I = q_t q_A \frac{P}{A t R}$$

$$E = q_A \frac{P}{A R}$$

- $q_A$  = Lateral beam quality factor
- $q_t$  = Temporal beam quality factor
- $A$  = Half width area
- $P$  = Average beam power
- $R$  = Repetition rate
- $t$  = Half width pulse duration

### Quality factors for stating of LIDT values

- Temporal pulse shape  $q_t$ : fraction of energy within temporal FWHM
- Lateral beam shape  $q_A$ : fraction of energy within lateral FWHM

Comparison of fs-LIDT values, measured with different setups, can be critical because each fs setup has a very unique pulse shape.

### Beam diameter is important

- LIDT is usually normalized to beam spot area, but a larger beam will likely illuminate more defects. This may result in a smaller damage threshold.

# Group Delay Distortion (GD & GDD)

## Group Delay Dispersion (GDD)

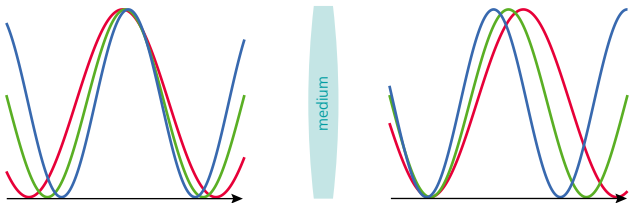
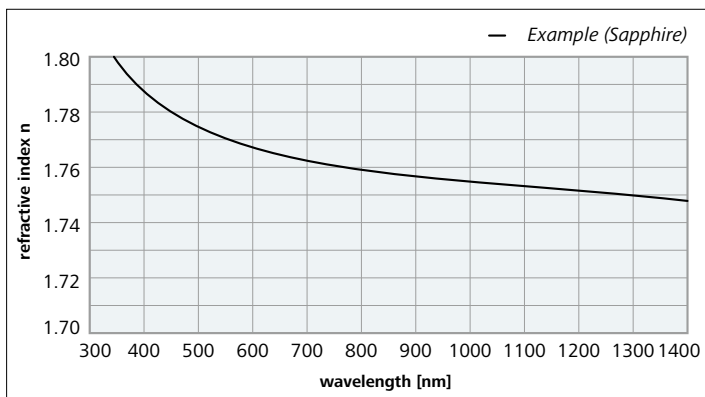
### Basics

The velocity of each wavelength  $\lambda$  is a function of the refractive index  $n$ .

$$v(\lambda) = \frac{c_0}{n(\lambda)}$$

- $c_0$  = Speed of light in vacuum
- $n$  = refractive index
- $v$  = velocity

### Example (Sapphire)

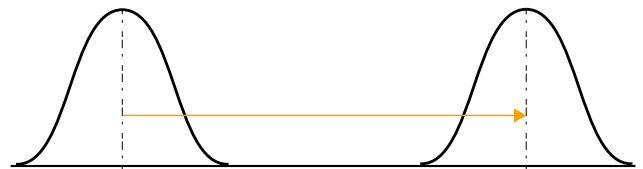


As you can see in the example above, longer wavelengths are faster than shorter ones. This is called »normal dispersion«.

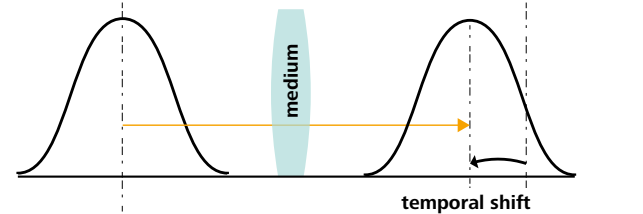
### Result

The propagation of a compressed laser pulse through a dispersive medium (gasses, crystals, glass,...) will change the temporal pulse shape.

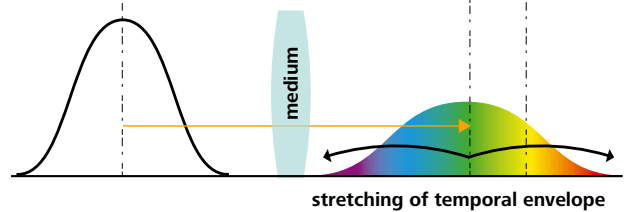
#### Reference pulse



#### Group Delay (GD)



#### Group Delay Dispersion (GDD)



#### GDD > 0 (Normal Dispersion)

→ Shorter wavelengths propagate slower than longer wavelengths (»red is faster than blue«)

#### GDD < 0 (Anomalous Dispersion)

→ Shorter wavelengths propagate faster than longer wavelengths (»blue is faster than red«)

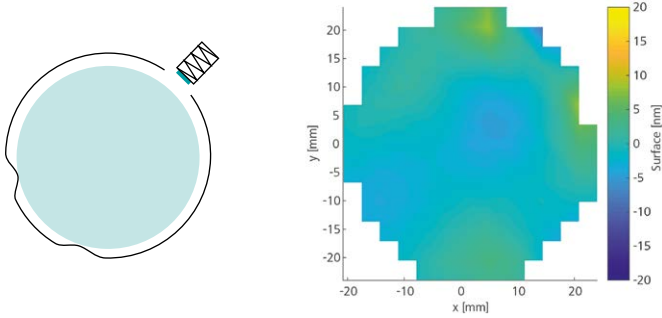
# How to Mount Optics

## How to Mount Optics

While mounting optics mechanical stress is introduced into the substrate, which in turn can deform the mirror surface.

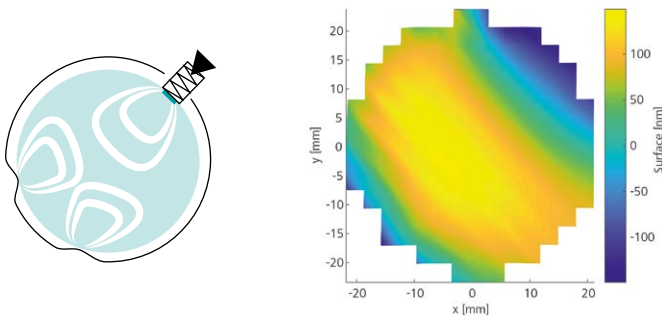
### 3-point mount without tightening

Optics without stress, but it might fall out if tipped.



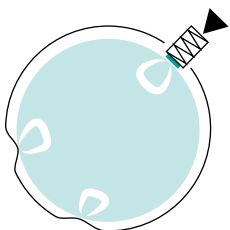
### 3-point mount with excessive tightening

Optics with too much mechanical stress.



### 3-point mount with appropriate tightening

Best option. LAYERTEC recommends to reduce the tightening of the grub screw slightly after mounting and positioning the optics.



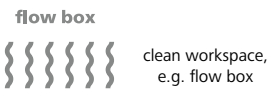
### TAKE CARE WITH RING MOUNTS!

By using ring mounts, you can damage your optics. Even small friction can splinter the coating and render it unusable. Optics in a ring mount may also seize up easily during assembly.

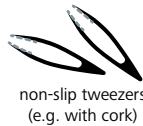


# Cleaning of Optical Surfaces

## Workspace



optical cleaning tissue (LAYERTEC recommends Whatman®)



non-slip tweezers (e.g. with cork)



spectroscopy grade acetone in a suitable bottle



latex/nitrile gloves (powder free)



air blower

## Precleaning



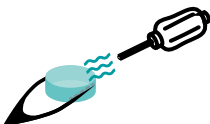
1. Clean hands with soap.



2. Dry hands.



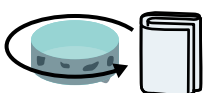
3. Use appropriate gloves.



4. Blow off dust from all sides.

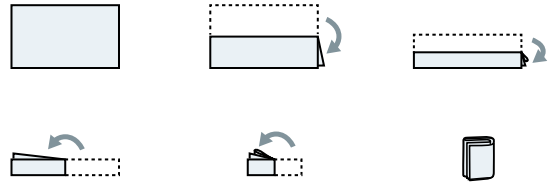


5. Moisten tissue with acetone. Do not contaminate the bottle! Compared to alcohol, acetone is the better solvent. It evaporates quickly and thus reduces the formation of streaks significantly.



6. Remove coarse dirt from edge and chamfer of substrate.

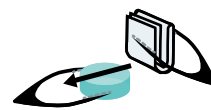
## Cleaning



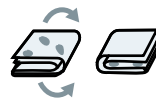
1. First fold new tissue along the long side several times. Then fold across until you have a round edge.



2. Moisten tissue with acetone. Only moist, not dripping wet. Otherwise, there will be streaks.



3. Grab moistened tissue or use tweezers. Hold sample with second tweezers. Slide tissue from one edge of the sample to the other once.

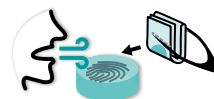


4. Do not use the same part of the tissue again. Turn tissue inside out (at most once!). If the surface is not clean then, use a new tissue.



Attention: Use acetone only for sputtered surfaces!

## Little Hints



- Fingerprints on sputtered coatings: Moisten surface by breathing on it, slide acetone-moistened tissue over surface as long as water film is still visible. – Never do this with hygroscopic substrates (CaF<sub>2</sub>,...)!



- Clean concave surfaces using a less folded tissue that can be slightly bent in the center. Use your thumb to gently press the tissue onto the curved surface.



- When cleaning, fix small samples on a concave support (polished, clean glass) using tweezers.



- Store samples on concave polished glass support that has been cleaned using tissue+acetone.

# Company

## Chapter Index

<b>History</b> .....	<b>193</b>
The Founding Story .....	193
Technological Evolution .....	194
<b>General Terms and Conditions of Sale (Effective 01/04/2016)</b> .....	<b>197</b>
<b>Payment and Shipment</b> .....	<b>202</b>
Volume Discount .....	202
Payment Methods .....	202
Shipment Terms and Costs .....	202
<b>Imprint</b> .....	<b>203</b>

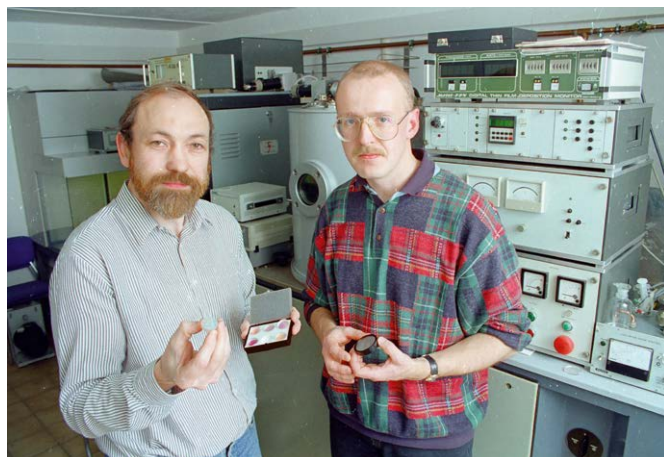
# History

## The Founding Story

LAYERTEC (optische Beschichtungen) GmbH is the first spin-off from the Friedrich Schiller University in Jena after the political changes in East Germany. The founder of the company, Hartmut Heyer, studied physics in Jena between 1976 and 1981. Until 1989 he worked as a scientific assistant on the technology of sputtering for the production of oxide coatings for optical applications. The basis for these developments were the novel PPS5 magnetron sputter sources of the Manfred von Ardenne Institute in Dresden.



**Figure 1:** LAYERTEC in 1990



**Figure 2:** Hartmut Heyer (founder) and Dr. Peter Zimmermann (first employee), 1992

Hartmut Heyer succeeded in several groundbreaking developments:

- Semi-reactive process control for the production of oxidic layers from the metal target
- RF-excited plasmas for sputtering from oxidic targets
- Optical monitoring of the layer thickness through the magnetron source and the plasma

This enabled Hartmut Heyer to produce the first complex, low-loss interference coating systems for laser applications starting around 1986. VEB Carl Zeiss Jena first introduced HeNe lasers in orange and green around that time. The resonator mirrors were manufactured by Hartmut Heyer using the new technology.

In 1986, Hartmut Heyer had purchased an old homestead in Mellingen, a village between Jena and Weimar. In 1990-91, the first laboratory rooms were set up in two garages in the adjoining property (a former butcher's shop). In January 1992, the production of custom products for research and development started, initially for customers in Germany. In 1994, LAYERTEC was awarded the Innovation Prize of German Medium-Sized Businesses. Starting as a one-man operation, LAYERTEC has developed into a globally active company with about 400 employees today.



**Figure 3:** LAYERTEC today (in 2022)

## Technological Evolution

### 1990 – 2000

Optical interference coating systems usually consist of a carrier (e.g. a Fused Silica substrate) and a single- or double-sided coating.



Figure 4: Different laser mirrors

In 1992, LAYERTEC started the production of magnetron sputtered coating systems. At the beginning, the substrates were bought externally. In 1993, the company started to build up its own substrate production with experienced precision opticians from the former VEB Carl Zeiss Jena. The complete production chain has been in place since 1994, making it possible to manufacture high performance optics from a single source, starting with the raw glass.

In 1995, evaporated systems made of fluoride and oxide materials for UV applications were sold for the first time.



Figure 5: Large optics ultrasonic cleaning process

Further innovations were clean room capable packaging systems and an automated ultrasonic cleaning of coated and uncoated substrates.



Figure 6: Packaging of LAYERTEC optics

Starting in 1997, it has been possible to customize and supplement the classic production chain (substrate production-cleaning-coating-packaging). Since then, coating is no longer necessarily the last process step in production. For example, low-cost miniaturized, fully coated optics have been added to the portfolio. Here, the smallest parts are diced or drilled out of large coated plates and cleaned fully automatically.

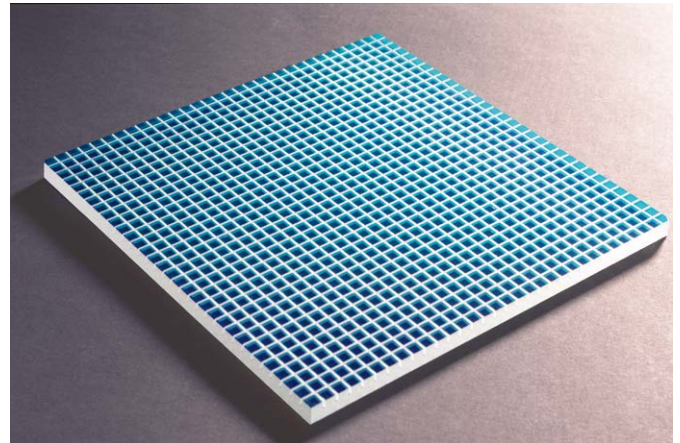


Figure 7: Diced plate

LAYERTEC has always manufactured single pieces for universities and other research institutions. For better marketing an online store was established in 1998.

Coating technologies have been continuously improved since the company was founded. Thus, extremely low-loss interference coating systems could increasingly be produced and components for high power lasers became a core competence.

Dispersive mirrors were produced for customers from Vienna for the first time in 1997/98. LAYERTEC developed corresponding calculation software and commissioned, among others, the Fraunhofer ILT Aachen with the construction of several GDD measurement set-ups.



Figure 8: Small laser mirror

## 2000 – 2010

In 2002, the company moved to its current location. Around 2005, there were considerations to produce coated optics up to approx. 600 mm in diameter. An inline sputtering system was set up to coat substrates of this size in 2007. Due to the high flatness requirements of large mirror substrates, it was not possible to use classic planar or spherical grinding and polishing processes. Therefore, zonal polishing was established as a manufacturing technology for the correction of plane surfaces.



Figure 9: Off-axis parabolic mirror

## 2010 – 2023

Between 2010 and 2012, the production space was expanded by several new buildings. Since 2010, LAYERTEC has been investing heavily in technological expertise and the associated development of suitable instruments in the fields of metrology, optics production and ultrasonic cleaning. Based on this expertise, a large number of unique measurement set-ups were created for the characterization of optical properties in the ppm range. Reflectance and transmittance can be measured by several CRD setups. Absorption losses can be determined by PCI. Moreover, an automated defect control system was developed which enables LAYERTEC to characterize polishing and coating defects according to ISO 10110.

In 2013, the entire production control system was converted to SAP in order to efficiently manage the large number of products.

In 2010 and 2012, LAYERTEC installed modern IAD plants which are mainly used for the coating of large optics for high power ultrafast lasers and for line beam optics. Since 2017, LAYERTEC has been meeting the demands of the industry to produce optics with 1.20 m edge length. For this purpose, the machinery was greatly expanded to include manufacturing, ultrasonic cleaning and the corresponding metrology.



Figure 10: Large scale optic

This technology enables the production of aspheric surfaces. A special process development and the corresponding metrology were required. LAYERTEC has been able to manufacture and measure aspherical substrates in-house from around 2012.

In 2007, the first IBS coating machines (Veeco) were integrated into the manufacturing process.

In 2015, LAYERTEC began to laser engrave all finished Fused Silica components.



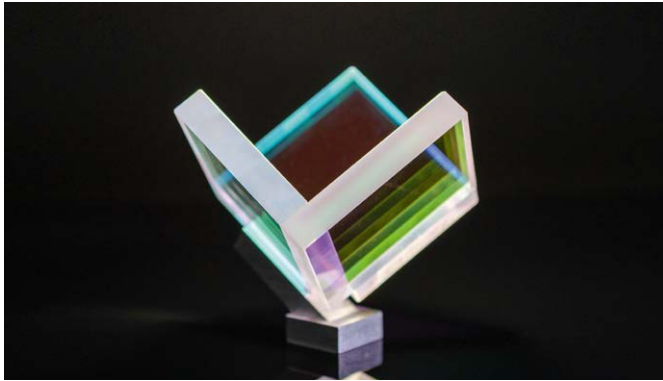
Figure 11: Laser engraving on different mirror sizes

Around 2018, the technological competence was acquired to change the shape of glass substrates also with ultrasonic technologies or to produce new geometries.

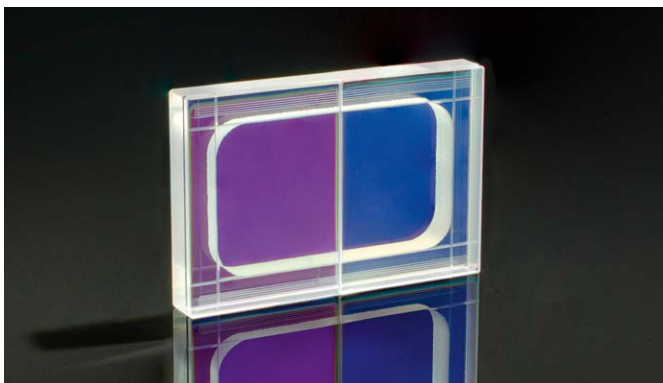


Figure 12: Conical hole, drilled in a Fused Silica substrate

Due to the customer's wish to use substrates or assemblies with increasing complexity, LAYERTEC started to invest into joining technologies and bonding of surface-activated polished surfaces in 2017. Since then, various joining technologies have been established: optical contacting, adhesive bonding, laser micro welding for unique parts and series production.

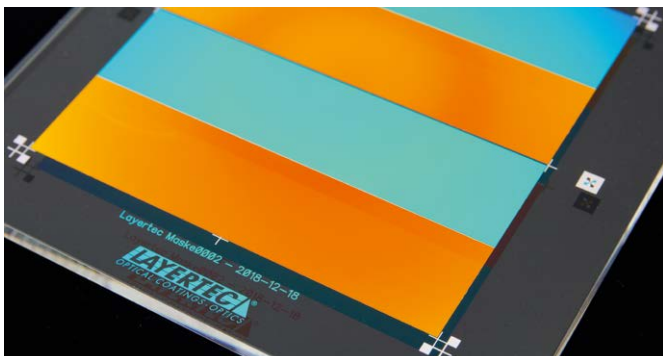


**Figure 13:** Retroreflector



**Figure 14:** Laser welded beam splitter

New technologies were being tested, including lift-off processes for structuring optical functional surfaces.



**Figure 15:** Lithographically structured optic

Filigree carrier structures are being produced to reduce weight.



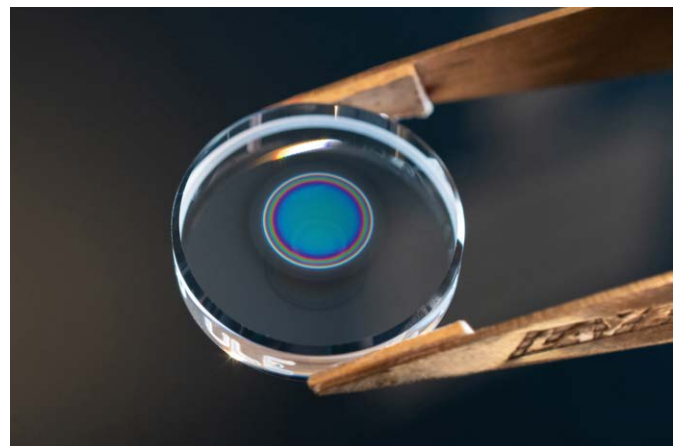
**Figure 16:** Scanning mirror with lightweight structures on the rear side

LAYERTEC's solderable coatings support customers in easily joining miniaturized optics.



**Figure 17:** Solderable coating on the side of a lens

High finesse cavity mirrors for the NIR and VIS spectral range were developed between 2018 and 2021. LAYERTEC is able to design and produce such mirrors also with two or three spectral regions of high reflectance.



**Figure 18:** Low loss optic

Also, during the Corona pandemic, LAYERTEC always remained a trusted partner for all customers from industry and research. By concentrating all the manufacturing steps in one facility the company could overcome the shortages in the international supply chains.

In 2021, LAYERTEC manufactured more than 250 000 coated laser optics from  $\varnothing$  1 mm to 1.20 m in length for more than 650 customers worldwide.

From 2018 to 2022, LAYERTEC planned and built a new facility with more than 6 000 m<sup>2</sup> of production space to reorganize the entire production.

# General Terms and Conditions of Sale (Effective 01/04/2016)

## I. Scope

- 1.1 The General Terms and Conditions of Sale set out in the following shall apply to all products and services to be provided by LAYERTEC GmbH (hereinafter called »LAYERTEC«). These General Terms and Conditions of Sale shall apply only to contracts with entrepreneurs in the sense of section 310 para. 1 BGB (German Civil Code) in conjunction with section 14 BGB.
- 1.2 Unless LAYERTEC has expressly agreed to them, any customer's general terms and conditions shall not become part of the contract. This shall apply also where LAYERTEC has not expressly contradicted, or where it performs deliveries or services without having contradicted, the customer's general terms and conditions.
- 1.3 These General Terms and Conditions of Sale shall be valid for deliveries and services in conjunction with the acknowledgement of a purchase order or a quotation by LAYERTEC.
- 1.4 The contract language shall be German. These General Terms and Conditions of Sale are made available in both German and English. In case of any discrepancy in the meaning of individual stipulations the German language version shall take precedence exclusively.

## II. Binding Agreement / Article of Sale / Copyright / Samples – Free Issue Materials

- 2.1 Unless expressly stated otherwise, any offer made by LAYERTEC shall be subject to confirmation and not binding and be merely construed as inviting offers to purchase/purchase orders from the customer.  
  
Insofar as LAYERTEC makes any binding quotation to the customer and unless stated otherwise by LAYERTEC in any given case, LAYERTEC shall be bound by its quotation for one month from the quoting date. The contract shall be deemed agreed upon and binding if the customer accepts the LAYERTEC quotation within the acceptance period. In this case, following acceptance by the customer, LAYERTEC shall send to the customer a written acknowledgement of the order.
- 2.2 Where a customer submits to LAYERTEC an offer to purchase without being in receipt of any LAYERTEC quotation, LAYERTEC may on the basis of these General Terms and Conditions of Sale accept the customer's purchase order within one month of receipt of the order at LAYERTEC. In general, this is done by means of a written acknowledgement of the order.
- 2.3 The subject of the delivery or service to be provided by LAYERTEC is the product named in the order acknowledgement by LAYERTEC and in the specifications referred to in the acknowledgement.  
  
Any publicity brochures or similar information on the homepage of LAYERTEC, etc., and documentation or performance characteristics on which the offer or the order acknowledgement by LAYERTEC is based, such as figures, drawings, information as to dimensions and weight or intended process technology for the deliveries and services of LAYERTEC as a rule constitute approximations only and are not binding, unless they are expressly declared binding. Properties of any samples or patterns, etc., shall only become part of the contract where this is expressly agreed upon. The customer shall have no right to pass on any samples or patterns, etc., unless LAYERTEC has given its consent or performance of the contract necessitates it.
- 2.4 To the extent that LAYERTEC has not by contract or under compelling statutory regulations expressly granted to the customer any rights to figures, drawings, software, cost estimates, knowhow, or other data and materials (collectively »information«), LAYERTEC shall retain any and all rights of ownership and copyright with respect to such information. Without the written consent by LAYERTEC such information must not be disclosed to any third party and must be safeguarded by appropriate means against any unauthorised access by third parties. This applies in particular to all "confidential" information. The customer must not use information of LAYERTEC, nor pass it on to any third party, for any purpose other than those agreed upon or assumed in the contract with LAYERTEC. Furthermore, no information must be passed on without the customer requiring such third party to sign a written confidentiality agreement in accordance with this section.
- 2.5 Any provision by the customer of samples for the manufacture of the product or of free issue materials, especially of material to be coated, shall be free of charge for LAYERTEC. On receipt, LAYERTEC will check samples and free issue materials for complete quantity only. LAYERTEC is not obligated to check quality or functionality. Except as stipulated in section IX. LAYERTEC shall not assume any liability for samples and free issue materials. Any samples and free issue materials not used for the contractual purposes will be returned together with the delivery of the product purchased.

## III. Delivery / Default / Passing of Risk

- 3.1 Delivery dates and lead times shall be agreed upon for each case specifically and shall not be binding unless they are expressly stated as »binding«. LAYERTEC will strive to meet any time/date not expressly agreed upon as binding. Lead times shall commence to run on the date the acknowledgement of the order is received, but not before all the details of the execution of the service to be rendered or the manufacture of the product have been agreed upon.

The delivery dates or lead times agreed upon shall slip or be postponed in the event that any industrial action should take place at LAYERTEC or any of its suppliers relevant to the supply of the product or the rendering of the service to the customer. Also, the delivery dates or lead times shall slip or be postponed in the event of any unexpected circumstances occurring that are beyond the control of LAYERTEC, e.g. sub-suppliers in delay, late delivery of materials, denial of official shipping permits, government action, confiscation of the contractual product, unrest, sabotage, lack of material or power, as long as such circumstances are relevant to the delivery of the product or service to the customer and not attributable to LAYERTEC. In all the above cases leading to extended lead time or postponed delivery date, the lead time shall be extended or the delivery date postponed by the duration of the impeding circumstances. This shall also apply where LAYERTEC is in delay with its delivery or service at the time such circumstances occur.

- 3.2 Should the lead time be extended or delivery date be postponed in accordance with item 3.1 para. 2 by more than three months, the customer shall have the right to set a reasonable period of grace for LAYERTEC to perform its delivery or service. If LAYERTEC fails to deliver within the period allowed, the customer shall have the right to terminate such part of the contract as is not yet performed. Should LAYERTEC have delivered part of the contract performance, the customer shall not have the right to terminate the entire contract, unless the customer is not interested in the part already delivered.
- 3.3 Should the customer request any changes to the product or should changes to the product become necessary in accordance with item 6.1 or 6.2, the lead time shall be extended or the delivery date postponed by such period of time as is required for making the change to the product.
- 3.4 Should the customer delay or fail to perform any action of cooperation necessary on its part for the product or service to be provided, then the lead time shall be extended or delivery date shall be postponed by such period of time as the customer takes to rectify the cooperation omitted on its part. Consequently, the grace period shall start at the time the cooperation would have been due according to the contractual agreement. If no time has been specified for the action of cooperation to be performed the grace period shall commence with the receipt by the customer of LAYERTEC's request for cooperation. The grace period ends with the completion of the action of cooperation by the customer.
- 3.5 Unless stipulated otherwise, delivery of the product or service shall be ex works. Unless otherwise agreed upon, LAYERTEC shall at the customer's expense purchase goods in transit insurance for reasonable cover at reasonable cost.
- 3.6 Instalment delivery or service shall be allowed to the extent deemed acceptable to the customer.
- 3.7 The risk of accidental loss or accidental deterioration of the product shall pass to the customer at the time the product is handed over to the customer or to the carrier employed by the customer. This shall apply to instalments or consignments as soon as the respective instalment or consignment is handed over.  
  
Should the customer fail to take delivery, the risk of accidental loss or accidental deterioration of the product shall pass to the customer at the time the customer fails to take delivery.
- 3.8 In the event of culpable failure on the part of the customer to take delivery or perform any other duty to cooperate, LAYERTEC shall be entitled to claim compensation for the resulting damage, in particular the profit lost including extra expenditure, if any.
- 3.9 Should LAYERTEC fail to deliver the product or service when due, the customer may set a reasonable period of at least two weeks within which LAYERTEC is to deliver. Upon futile expiration of such period the customer shall be entitled to terminate the contract. In this case the customer shall only have the right to claim damages for non-performance if such failure to perform was caused by intent or culpable negligence on the part of LAYERTEC, its legal representatives or agents. Damages for non-performance shall be limited to the loss typically predictable in such case.

#### IV. Price and Terms of Payment

- 4.1 All prices shall be deemed net prices exclusive of value added tax at the current statutory rate. Prices are ex works inclusive of normal packaging. Unless otherwise agreed upon, the amount invoiced shall be due for payment within 30 calendar days of the date the invoice is received.  
  
Where the product is modified at the customer's request, the customer shall bear the resulting costs. Where the product is specifically packaged or insured at the customer's request, the customer shall bear the resulting costs.  
  
In the event of any increase in material procurement costs, labour costs and costs of fringe benefits, energy costs and costs under environmental regulations, LAYERTEC shall have the right to unilaterally raise the purchase price reasonably (section 315 BGB (German Civil Code)) on the proviso that there are more than four months between the signing of the contract and the delivery.
- 4.2 In the case of export delivery the customer shall bear all taxes, customs duties and dues payable in conjunction with the sales contract outside the Federal Republic of Germany.
- 4.3 Insofar as the purchase price is not paid by cash deposit LAYERTEC may request reasonable collateral for the payment of the purchase price (e.g. documentary credit, bank guarantee, letter of credit) prior to despatch.
- 4.4 If and when the realisable value of all the secured claims LAYERTEC is entitled to, including the rights resulting from the extended retention of title under section V., exceeds the amount of all secured claims in the long term by more than 30%, LAYERTEC shall release an appropriate part of the collateral upon the customer's request. It shall be LAYERTEC's choice what collateral to release.
- 4.5 The customer shall not be entitled to deduct any counterclaim from the amounts payable to LAYERTEC, unless such counterclaim is undisputed or has been confirmed by final court decision. Moreover, the customer shall not exercise any right to hold back money, unless its counterclaim is based on the same contractual relationship.



## V. Retention of Title

- 5.1 The purpose of the retention of title agreed upon in the following is the assurance of all present and future claims receivable by LAYERTEC from the customer out of any supply or service contracts between the parties hereto (including any current account balance restricted to this business relationship).
- 5.2 LAYERTEC retains legal ownership of the product provided to the customer by LAYERTEC until all the secured claims have been paid up in full. The product, and in its place the goods subjected to retention of title under this contract will be referred to as the reserved goods in the following.
- 5.3 The customer shall store the reserved goods for LAYERTEC free of charge. The customer shall treat the reserved goods with care and purchase at its own cost fire, water damage and theft insurance for adequate replacement value cover.
- 5.4 The customer shall be entitled to process and sell the reserved goods in its normal course of business. The goods must not be pledged or assigned as security.
- 5.5 Where the reserved goods are processed by the customer, the processing shall take place in the name and for the account of LAYERTEC as the manufacturer and LAYERTEC directly acquires legal ownership or, where the processing involves materials of several owners or where the value of the processed item exceeds that of the reserved goods, an interest (fractional ownership) in the newly manufactured goods at the ratio of the value of the reserved goods to the value of the new goods. In case no such acquisition of ownership by LAYERTEC should occur, the customer hereby assigns to LAYERTEC as security its future title or interest at the above ratio in the new goods.

Where the reserved goods will be united or inseparably mixed with other goods to form mixed goods and any of the other goods are to be deemed the main goods, the customer, to the extent it owns the main goods, shall assign to LAYERTEC proportional interest in the mixed goods at the ratio named in sentence 1. LAYERTEC hereby accepts such assignment.

- 5.6 In order to provide security in case the reserved goods are sold on, the customer herewith assigns to LAYERTEC the resulting receivables from such purchaser, in proportion to the interest where LAYERTEC owns an interest in the reserved goods. The same shall apply to any other claims in place of the reserved goods or otherwise resulting with respect to the reserved goods, such as insurance claims or tort claims in the event of loss or destruction. LAYERTEC accepts this assignment.

LAYERTEC grants the customer revocable power to collect in its own name for the account of LAYERTEC the amounts receivable assigned to LAYERTEC. Should the customer act in breach of this contract, in particular should the customer fail to make payment when due, LAYERTEC may revoke this power to collect payments and require the customer to disclose to LAYERTEC the amounts receivable assigned and the respective debtors, to notify the respective debtors of the assignment made, and to provide to LAYERTEC all documentation and information LAYERTEC requires for asserting its claims.

- 5.7 Should any third party seize the reserved goods, especially by attachment, the customer shall immediately point out to such third party the legal ownership of LAYERTEC and shall notify LAYERTEC so that it may assert its title rights. To the extent that such third party should not be able to remunerate the legal and other costs incurred by LAYERTEC in this case, the customer shall be liable to pay such costs.
- 5.8 Should the customer act in breach of this contract, in particular should the customer fail to make payment when due, LAYERTEC shall have the right to repossess the reserved goods after setting a reasonable grace period for the contractual obligations to be performed. The costs of transport for the purpose of repossession shall be borne by the customer. Repossession by LAYERTEC of the reserved goods constitutes termination of the contract. Seizure of the reserved goods by LAYERTEC also constitutes termination of the contract. Reserved goods repossessed by LAYERTEC may be utilised by LAYERTEC. The revenue from such utilisation, after LAYERTEC has deducted a reasonable amount for the utilisation costs, shall be deducted against such amounts as the customer owes to LAYERTEC. If LAYERTEC terminates the contract because the customer is in breach of contract, especially in default of payment, LAYERTEC shall be entitled to demand the reserved goods to be returned.
- 5.9 Should a retention of title clause in favour of LAYERTEC be wholly or partly impossible or ineffective for legal or factual reasons, the customer shall be obliged, at the request of LAYERTEC, to create a legal and effective assurance (e.g. a lien on the object of purchase) for LAYERTEC. Should there be a variety of securities to be considered, then LAYERTEC shall have the choice as to what security is to be registered. LAYERTEC shall decide in its reasonable discretion.
- 5.10 The customer undertakes not to cause any changes to the specifications of the product without the prior written consent of LAYERTEC and not to attach to it or use in connection with the product any additional equipment not approved by LAYERTEC for as long as legal ownership of the reserved goods has not yet passed to the customer.

## VI. Change to Specifications

- 6.1 Up to the delivery of the object of purchase LAYERTEC may change specifications of the product as long as such changes are necessary in order to manufacture a flawless product, do not alter essential technical characteristics of the object of purchase and are deemed acceptable to the customer. Also, the customer shall agree to further changes suggested by LAYERTEC, insofar as these are acceptable to the customer. Where such changes would cause the purchase price to increase, this shall be agreed upon between the parties prior to the execution of such changes.

Moreover, up to the delivery of the product, LAYERTEC may change the process technology intended for manufacturing the product at the time the order was placed, insofar as this will not change essential technical characteristics of the object of purchase and such changes are deemed acceptable to the customer.

- 6.2 Any changes to specifications of the product, of accessories or other services, which prior to their delivery should become necessary because of statutory regulations or official orders outside the Federal Republic of Germany shall be carried out by LAYERTEC at the customer's expense.

## VII. Warranty

- 7.1 The customer shall check the product immediately on delivery. The customer shall report by written notification any obvious defect immediately and no later than within seven days of delivery, and any hidden defect immediately and no later than within seven days of its detection.
- 7.2 LAYERTEC may at its discretion repair or replace ANY defective delivery or service within a reasonable grace period. In the event that such repair or replacement should fail twice, the customer may at its discretion reduce the purchase price or terminate the contract.
- 7.3 Unless otherwise agreed upon, the warranty period for the product including any accessories bought with it is 12 months from the date of delivery.

No liability shall be assumed for normal wear and tear. Moreover, LAYERTEC shall not be responsible for the applicability of the product for any particular use or purpose, unless this is expressly agreed upon between the parties. Furthermore LAYERTEC shall not be liable for any suitability of the product, insofar as the product is not used for its ordinary use, unless this is expressly agreed upon between the parties.

- 7.4 LAYERTEC shall not assume responsibility or warranty for any defect or damage to the product, if the customer itself or with the help of any third party not instructed or authorised by LAYERTEC has carried out any repair, rectification or installation work on the product, the customer has failed to observe the manufacturer's instructions or has used the product inappropriately, unless the customer disproves the substantiated assertion by LAYERTEC that the defect or damage concerned is attributable to and was caused by such repair, rectification or installation work by the customer or any unauthorised third party, failure to observe the manufacturer's instructions or any inappropriate use etc. of the product.
- 7.5 Where LAYERTEC provides coating services on materials to be coated or other free issue materials provided by the customer, LAYERTEC shall not be liable for any defect in the coating services insofar as such defect is attributable to the material for coating or any other free issue material provided by the customer.
- 7.6 The costs of any unjustified notice of defects by the customer, in particular the costs of inspecting the defect notified, shall be borne by the customer.

## VIII. Intellectual Property Rights; Defect of Title

Unless otherwise agreed upon, LAYERTEC shall provide the product free of any third party industrial trademark or copyrights (hereinafter: intellectual property rights). Should any third party lodge any justified claim against the customer for infringement of intellectual property rights by its contractual use of products or services provided by LAYERTEC, then LAYERTEC shall be liable to the customer as follows:

- 8.1. LAYERTEC shall at its discretion and at its own cost obtain the right of use for the products or services concerned or, where deemed acceptable to the customer, modify or replace the product or services in such a way that there is no infringement of the intellectual property right.

If this is not possible at reasonable terms for LAYERTEC, the customer shall be entitled to make use of its statutory rights of termination or price reduction. The customer shall not be entitled to claim compensation for futile expenditure.

For any obligation to pay damages refer to section IX.

- 8.2. The above obligations on the part of LAYERTEC shall not be valid unless the customer notifies LAYERTEC forthwith in writing about any claim lodged by any third party and all defensive measures and settlement conferences are reserved to LAYERTEC.

The customer shall not have the right to acknowledge to the third party any infringement of intellectual property rights, unless LAYERTEC has agreed to such acknowledgement. In the event that the customer should discontinue the use of the products or services for mitigation or other reasons, the customer shall be obliged to point out to the third party that its discontinuation of the use does not constitute any acknowledgement of an infringement of intellectual property rights.

- 8.3. Any claim on the part of the customer shall be precluded where any infringement of intellectual property rights is attributable to the customer or where infringements of intellectual property rights have been caused by design documentation or any other specific demand made by the customer with respect to the product or service or have been caused by inappropriate use, or by the customer altering the product or service or using it together with products not supplied by LAYERTEC.
- 8.4. The stipulations of section VII. shall be applied accordingly with respect to other defects of title. The customer shall have no further right to lodge any claim beyond those in sections VIII. and VII. against LAYERTEC on grounds of any defect of title.

## IX. Damages

- 9.1 LAYERTEC shall not be liable in cases of ordinary or slight negligence.
- 9.2 In the event of gross negligence the liability of LAYERTEC shall be limited to such damage as can typically be expected to occur.
- 9.3 The disclaimer and limitation of liability under items 9.1 and 9.2 shall not apply where the liability of LAYERTEC is caused by intent, by the absence of any property promised or guaranteed, by mandatory liability under product liability legislation, injury to life, limb or health, violation of fundamental contractual obligations (obligations required for the proper execution of the contract and the performance of which the customer had a right to rely upon) or by any other legally mandatory liability.
- 9.4 The stipulations in items 9.1 to 9.3 shall also apply to any claims of the customer against employees or agents of LAYERTEC.
- 9.5 The stipulations in items 9.1 to 9.3 shall also apply where legal representatives or assistants of LAYERTEC have been acting on behalf of LAYERTEC.

## X. Miscellaneous

- 10.1 Any and all agreements between LAYERTEC and the customer shall be made in writing. Any waiver of this requirement of written form shall be made in writing only.
- 10.2 Without the prior consent of the party concerned, both parties to the contract must neither utilise nor disclose to any third party any of the other party's trade secrets or confidential information which have become known to them during their business relationship, unless such trade secret or confidential information is in the public domain. This shall also apply after the execution of this contract.
- 10.3 This contract shall be governed by the law of the Federal Republic of Germany; the provisions of the United Nations Convention on Contracts for the International Sale of Goods dated 11/04/1980 shall not be applied.
- 10.4 The exclusive legal venue for any claims arising out of this contract shall be Weimar, unless there is any statutory exclusive legal venue. Place of performance for all deliveries, services and payments shall be Mellingen.
- 10.5 Should any stipulation of this contract be or become void in whole or in part, or should there be any omission in this agreement, this shall not affect the validity of the remaining stipulations of this contract.

# Payment and Shipment

## Volume Discount

LAYERTEC offers a volume discount for standard items from five pieces up.

*Table 1: Volume discount*

Pieces	Discount
From 5 pieces up	5 %
From 10 pieces up	10 %
From 20 pieces up	20 %

## Payment Methods

LAYERTEC accepts the following payment methods:

- Credit card (VISA, Mastercard)
- Wire transfer

LAYERTEC reserves the right to request advance payment.

## Shipment Terms and Costs

LAYERTEC ships your components from Germany. If not requested otherwise, UPS delivery service with DPU Standard according to Incoterms 2020 is used. This standard includes the following conditions:

- The vendor pays the shipping costs.
- The customer pays duty and taxes.
- The item is fully insured from doorstep to doorstep.

*Table 2: Shipping fee by destination*

Destination	Shipping fee
Within Germany	20 €
European Union (EU)	70 €
Other countries	100 €

The shipping time with UPS worldwide is usually less than 1 week. On request, it is possible to choose another delivery service (e.g. FedEx or DHL). If you choose another shipping service, please consider that shipping fees and the average shipping time may differ.

Please make sure to mention the complete shipping address of your company or research facility. If available please also disclose the optional VAT-number and the account number of your preferred delivery service.

If you have further questions please feel free to contact LAYERTEC.

# Imprint

<b>Edition:</b>	<b>2<sup>nd</sup> Edition, © LAYERTEC, 2024, January</b>
<b>Phone:</b>	<b>+49 36453 744 0</b>
<b>E-mail:</b>	<b>info@layertec.de</b>
Internet:	www.layertec.de
Fax:	+49 36453 744 40
Phone (US):	+1 707 48 10216
E-mail (US):	ussales@layertec.com
Location:	LAYERTEC GmbH Ernst-Abbe-Weg 1 99441 Mellingen GERMANY
Images:	LAYERTEC GmbH

LAYERTEC GmbH  
Ernst-Abbe-Weg 1  
99441 Mellingen  
GERMANY

Phone: +49 36453 744 0  
Fax: +49 36453 744 40  
E-mail: [info@layertec.de](mailto:info@layertec.de)  
Web: [www.layertec.de](http://www.layertec.de)

Phone (US): +1 707 48 10216  
E-mail (US): [ussales@layertec.com](mailto:ussales@layertec.com)

